



# SUNTOUCH® CONTROL SYSTEM FOR POOL AND SPA



## INSTALLATION AND USER'S GUIDE

IMPORTANT SAFETY INSTRUCTIONS  
READ AND FOLLOW ALL INSTRUCTIONS  
SAVE THESE INSTRUCTIONS

**Customer Support**

**Sanford, North Carolina** (8 A.M. to 4:30 PM  
ET)

**Moorpark, California** (8 A.M. to 4:30 PM PS)

**Phone:** (800) 831-7133

**Fax:** (800) 284-4151

**Web sites**

<http://www.pentairpool.com> and [staritepool.com](http://www.staritepool.com)

# Contents

<b>IMPORTANT WARNING AND SAFETY INSTRUCTIONS.....</b>	<b>iii</b>
Technical Support.....	vi
<b>Section 1: SunTouch Pool and Spa Control System Overview .....</b>	<b>1</b>
SunTouch Control System Overview .....	1
SunTouch Solar Mode .....	1
SunTouch Pool/Spa Mode .....	1
SunTouch Control Panel.....	2
SunTouch Control Buttons.....	2
SunTouch Main Status Screen (Solar Only mode).....	4
SunTouch Solar Only System.....	4
Operating SunTouch in Solar Only Mode .....	5
Setting up SunTouch for Solar Only mode from Pool/Spa mode.....	5
Adjusting the water temperature setting (Solar Only mode).....	6
Solar Only Menus .....	6
Set Temperature .....	6
System Control .....	7
System Mode.....	7
Time Set .....	7
Start and Stop Temp Differentials .....	8
Solar Freeze protection .....	8
Cleaner Freeze protection .....	8
Air sensor.....	8
Freeze Protection in Solar Only mode.....	9
Operating SunTouch in Pool/Spa mode (Shared Equipment) .....	9
Setting up SunTouch to Operate in Pool/Spa mode .....	9
Adjusting the water temperature setting in Pool/Spa mode.....	9
Selecting the heat source .....	10
SunTouch Main Status Screen (Pool/Spa mode - Shared Equipment) .....	11
Pool/Spa Mode Menus (Shared Equipment) .....	12
<b>Pool/Spa Mode Menus .....</b>	<b>13</b>
Circuit On/Off Menu (1/14) .....	13
Heat Menu (2/14).....	14
Pool Temperature and Heat Source settings.....	14
Spa Temperature and Heat Source .....	15
HI-TEMP /LO-TEMP (Pool or Spa) Control Button.....	15
Manual Heat (Off/On) .....	15
Delay Cancel Menu (3/14).....	16
Schedules Menu (4/14) .....	17
Schedule your Spa or Pool.....	18
Edit an existing program.....	18
Delete a program.....	18
Clock Menu (5/14) .....	19
Solar Menu (6/14).....	19
Valves Menu (7/14).....	21
Advanced Menu (8/14): Heater and Valve Delays.....	22
Advanced Menu (8/14): Temp Units - F° / C° (Fahrenheit/Celsius) .....	22
Advanced Menu (8/14): Calibrate water, air and solar sensors .....	23
Advanced Menu (8/14): Air Sensor Enable/Disable.....	24
Advanced Menu (8/14): System Mode .....	24

## Contents

Advanced Menu (8/14): System Type.....	24
Advanced Menu (8/14): Circuit Time Out.....	24
Advanced Menu (8/14): Reset Factory .....	25
Diagnostics Menu (9/14): Firmware Rev .....	25
Diagnostics Menu: Solar Temp.....	25
Diagnostics Menu: Self Test .....	25
Diagnostics Menu: IntelliChem.....	25
Circuit Functions Menu (10/14) .....	26
Assigning Circuit Functions .....	26
Freeze Protection .....	26
Circuit Functions.....	26
Preset Circuit Functions .....	27
Settings Menu (11/14): QuickTouch (QT4) Wireless Remote.....	28
Assign QT4 buttons .....	28
Pump Menu (12/14).....	28
Single speed filter pump.....	28
Two-speed filter pump .....	29
IntelliFlo VS pump .....	30
Freeze Protection .....	30
IntelliFlo VF pump.....	32
IntelliFlo VSF+SVRS pump .....	35
IntelliChlor Menu (13/14) .....	36
IntelliChlor Menu (13/14): Status and Error Messages.....	36
Service Menu (14/14): Service, Timeout, Auto .....	38
SunTouch Main Status Screen (Pool/Spa Mode - Single Body System).....	39
High/Low Temperature Circuit Control (Single Body System) .....	40
HI-TEMP / LO-TEMP Circuit Controls .....	40
Setting up SunTouch to operate as a Single Body system.....	40
Pool/Spa Mode (Single Body of Water) Menus .....	41
<b>Section 2: Installation and Setup .....</b>	<b>42</b>
SunTouch System Installation Steps Summary.....	42
Required Tools.....	42
SunTouch Solar Package Contents.....	43
SunTouch Control System Contents.....	43
Replacement Parts .....	43
Optional Equipment .....	43
SunTouch System Overview.....	44
Plumbing Requirements .....	46
Equipment Location.....	47
Solar Hydraulics System .....	48
SunTouch Power Center High Voltage Connections.....	49
SunTouch Power Center Location .....	49
Grounding and Bonding to the SunTouch Power Center.....	50
Preparing the SunTouch Power Center .....	51
Opening the front panel.....	51
Mounting the SunTouch Power Center.....	52
Removing Electrical Conduit Knockouts.....	53
Installing Conduit and Wire to the SunTouch Power Center.....	54
Transformer Connections .....	55
High Voltage Wiring .....	55
SunTouch Motherboard Connections .....	56
Equipment Power .....	56
Accessing the SunTouch Motherboard .....	57
Installing Auxiliary Relays .....	58
Relay locations .....	58
Installing relays.....	58

# Contents

Installing Valve Actuators.....	60
Adjusting the valve position .....	60
Installing and Connecting Temperature Sensors.....	61
Water Temperature Sensor.....	61
Ambient Air Temperature Sensor (for freeze protection) .....	61
Solar Temperature Sensor.....	61
Connecting SunTouch to a Gas Heater.....	62
Connecting to a standard heater .....	62
Connecting to a MiniMax, MasterTemp Gas Heater.....	62
Connecting to a Sta-Rite Gas Heater .....	63
Connecting a Standard Heat Pump or Electric Heater .....	63
SunTouch Solar System Installation.....	64
SunTouch Solar System Start-Up.....	64
Pool Cleaner Protection.....	64
SunTouch Pool/Spa Controller System Start-Up.....	65
Check Electronics .....	65
SunTouch System Test.....	65
Testing the auxiliary relays .....	65
Setting up the SunTouch system for the first time (after equipment Installation).....	66
Connecting IntelliChem to the SunTouch System .....	67
<b>Section 3: Troubleshooting .....</b>	<b>68</b>
Frequently Asked Questions (FAQ).....	68
How do I setup a two-speed pump? .....	68
Can I switch the heater on and change the temperature from the spa?.....	68
How do I switch on solar heating?.....	68
SunTouch Error Messages .....	69
Error Messages .....	69
Self Test Error Codes .....	69
Error Code Table .....	69
Resetting the System Fuses.....	69
Problem Solving a Solar System.....	70
SunTouch solar is not operating.....	70
Water flow to panels switch does not operate the valve actuator.....	70
Checking The Temperature Sensors .....	70
Testing the Solar System.....	70
Air Sensor Error .....	70
Temperature vs. Resistance Data .....	71
IntelliChlor Error Messages .....	72
System Problem Diagnosis .....	72
Problem: The Quick Touch remote will not work, or will not work dependably. ....	73
IntelliFlo Warning and Alarm Conditions.....	74
Alarm and warning LED sequence .....	74
SunTouch Specifications .....	74
Wiring SunTouch to the IntelliChlor Salt Chlorine Generator.....	75
Wiring Description (SunTouch to IntelliChlor, Hayward, Jandy).....	75
Wiring IntelliChlor (SCG) and Standard Pump to SunTouch.....	76
Wiring IntelliChlor (SCG) and IntelliFlo Pump to SunTouch.....	77
<b>Appendix .....</b>	<b>78</b>
Emergency Shut-Off switch (ESO3) .....	78
Location .....	78
Installing the (ESO3) Circuit Board.....	79
Commercial Application using ESO3 and SunTouch (Single Body System) .....	81
<b>Glossary .....</b>	<b>82</b>

## IMPORTANT WARNING AND SAFETY INSTRUCTIONS



### Important Notice:

**Attention Installer:** This manual contains important information about the installation, operation and safe use of this product. This information should be given to the owner and/or operator of this equipment. When installing and using this electrical equipment, basic safety precautions should always be followed, including the following:



**WARNING: IMPORTANT SAFETY INSTRUCTIONS PERTAINING TO A RISK OF FIRE, ELECTRIC SHOCK, OR INJURY TO PERSONS. READ AND FOLLOW ALL INSTRUCTIONS.**



- **DANGER! RISK OF ELECTRIC SHOCK, WHICH CAN RESULT IN SERIOUS INJURY OR DEATH.** Before attempting installation or service, ensure that all power to the circuit supplying power to the system is disconnected/turned off at the circuit breaker.
- Grounding (earth bonding) is required. The SunTouch® Control System Power Center should be installed by a qualified professional and grounded.
- **Read Safety Precautions and Important Instructions. Before attempting any electrical wiring, be sure to read and follow Safety Instructions. Wiring should only be performed by a qualified professional.**



**WARNING** - Before installing this product, read and follow all warning notices and instructions which are included. Failure to follow safety warnings and instructions can result in severe injury, death, or property damage. Call (800) 831-7133 for additional free copies of these instructions.



**WARNING** - Water temperature in excess of 100 degrees Fahrenheit may be hazardous to your health. Prolonged immersion in hot water may induce hyperthermia. Hyperthermia occurs when the internal temperature of the body reaches a level several degrees above normal body temperature of 98.6° F (37° C). The symptoms of hyperthermia include drowsiness, lethargy, dizziness, fainting, and an increase in the internal temperature of the body.

The effects of hyperthermia include: 1) Unawareness of impending danger. 2) Failure to perceive heat. 3) Failure to recognize the need to leave the spa. 4) Physical inability to exit the spa. 5) Fetal damage in pregnant women. 6) Unconsciousness resulting in danger of drowning.



**WARNING** - To reduce the risk of injury, do not permit children to use this product unless they are closely supervised at all times.



**WARNING** - The use of alcohol, drugs, or medication can greatly increase the risk of fatal hyperthermia in hot tubs and spas.



**WARNING** - Control System is intended to control heaters with built-in high limit circuits **ONLY**. Failure to do so may cause property damage or personal injury. All water will be routed through the heater assembly.



**WARNING** - Do not use this product to control an automatic pool cover. Swimmers may become entrapped underneath the cover.

## IMPORTANT WARNING AND SAFETY INSTRUCTIONS

### General Installation Information

1. All work must be performed by a licensed electrician, and must conform to all national, state, and local codes.
2. Install to provide drainage of compartment for electrical components.
3. If this system is used to control underwater lighting fixtures, a ground-fault circuit interrupter (GFCI) must be provided for these fixtures. Conductors on the load side of the ground-fault circuit-interrupter shall **not** occupy conduit, junction boxes or enclosures containing other conductors unless such conductors are also protected by a ground-fault circuit-interrupter. Refer to local codes for details.
4. A terminal grounding bar stamped  is located inside the SunTouch® Control System Power Center. To reduce the risk of electric shock, this terminal must be connected to the grounding means provided in the electric supply service panel with a continuous copper wire equivalent in size to the circuit conductors supplying this equipment (no smaller than 12 AWG or 3.3 mm). The bonding lug(s) provided on this unit are intended to connect a minimum of one No. 8 AWG for US installation and two No. 6 AWG for Canadian installations solid copper conductor between this unit and any metal equipment, metal enclosures or electrical equipment, metal water pipe, or conduit within 5 feet (1.5 m) of the unit.
5. The electrical supply for this product must include a suitably rated switch or circuit breaker to open all ungrounded supply conductors to comply with current National Electrical Code (NEC), NFPA 70 or the Canadian Electrical Code (CEC), CSA C22.1. The disconnecting means must be readily accessible to the tub occupant but installed at least 10 ft. (3.05 m) from the inside wall of the pool.

### Safety Notice

#### Important Safety Instructions

When installing and using this electrical equipment, basic safety precautions should always be followed, including the following:

#### READ AND FOLLOW ALL INSTRUCTIONS:



**WARNING** - To reduce the risk of injury, do not permit children to use this product.



**WARNING** - Water in excess of 100 degrees Fahrenheit may be hazardous to your health.



**WARNING** - For units intended for use in other than single-family dwellings, a clearly labeled emergency switch shall be provided as part of the installation. The switch shall be readily accessible to the occupants and shall be installed at least 10 feet (3.05 m) away, adjacent to, and within sight of, the unit.

### Two Speed Pump Controls Notice (Title 20 Compliance)

**Please read the following important Safety Instructions (See page 28 for pump speed setup)**

When using two-speed pumps manufactured on or after January 1, 2008, the pump's default circulation speed **MUST** be set to the **LOWEST SPEED**, with a high speed override capability being for a temporary period not to exceed one normal cycle, or two hours, whichever is less.

## **Technical Support**

**Sanford, North Carolina** (8 A.M. to 4:30 PM ET)

**Moorpark, California** (8 A.M. to 4:40 PM PT)

**Phone:** (800) 831-7133

**Fax:** (800) 284-4151

### **Web sites**

visit [www.pentairpool.com](http://www.pentairpool.com) and [staritepool.com](http://staritepool.com)



# Section 1

## Overview

### SunTouch® Control System Overview

Congratulations! On your purchase of the Pentair Aquatic Systems SunTouch® Control System - The next generation in intelligent pool and spa control systems. The SunTouch Control System quick-access menus helps you to setup control of your pool and spa daily operations. Your system can be easily configured to operate in “Solar Only” mode for solar systems, “Pool/Spa” mode for shared equipment systems or “Single Body of Water” mode for single equipment systems.

The SunTouch Control System supports the IntelliChem® Chemistry Controller, IntelliChlor® Salt Chlorine Generator (SCG), for pool water sanitizing and IntelliFlo® Variable Speed (VS) and IntelliFlo® Variable Flow (VF) Pump to meet all your pool and spa needs. For a complete list of the SunTouch Control System and optional equipment, see to page 43.

### Solar Mode

The SunTouch Control System Solar Mode provides automatic solar heating control using a differential temperature control designed especially for solar-heated swimming pool, spas, and hot tubs. Also included is solar nocturnal cooling control for optimizing heat control at night. Whenever solar energy is available, The SunTouch Control System will automatically activate a motorized three-port solar valve and/or the optional solar booster pump which controls the water flow direction, and pump pool water through the solar collectors. The filter pump timer can be set so the filter pump is operating during that time of the day when solar energy is available.

If you are using a pool cleaner booster pump for your pool, the SunTouch Control System will disable the pump for five minutes whenever the solar system turns on. This protects the pump from possible damage caused by residual air within the solar panels.

*Note: For information about setting up and operating the SunTouch Control System as a solar only system, see page 5.*

### Pool/Spa Mode

The SunTouch Control System Pool/Spa Mode provides automation controls for pool and spa shared equipment systems or for pool only or spa only “Single Body” systems. With the addition of two valve actuators, The SunTouch Control System can be configured to control your pool and spa heating and filtration schedules and additional features such as pool lights, automatic cleaners, or waterfalls.

Using the optional QuickTouch® (QT4) Wireless Remote controller you can control up to four circuits to activate the spa circulation, and for operating three auxiliary pieces of equipment (such as lights, jet pump, air blower, waterfall, etc.). For more information, see “Main Menu: QuickTouch (QT4) Wireless Remote,” on page 28.



SunTouch® Control System Power Center

## SunTouch® Control System Control Panel

Use the SunTouch® Control System panel buttons to program and control pool and spa operations. You can schedule daily operations to run automatically using the menu features, and manually adjust temperature settings, switch lights on and off, and setup pool/spa equipment. The LCD displays the current temperature settings, current time and equipment status information.

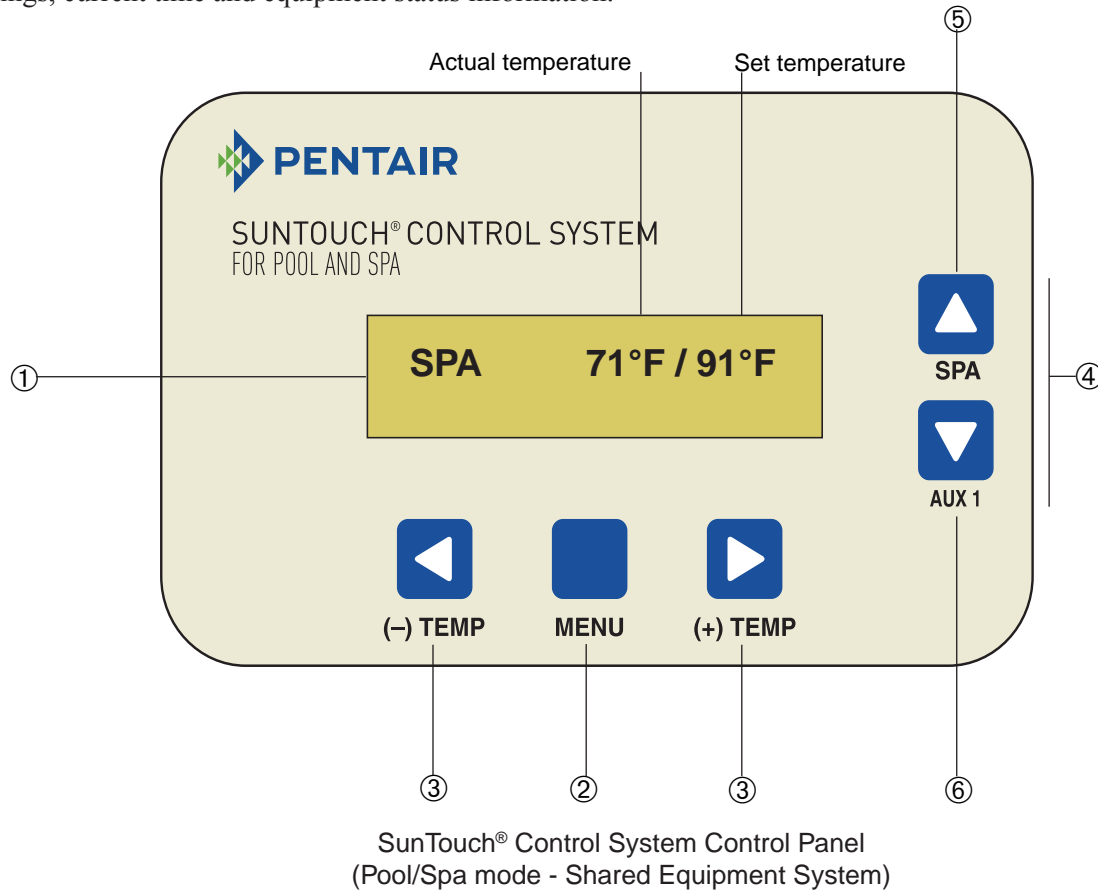

### Control Buttons

- ① **Liquid Crystal Display (LCD):** The main system display consists of a 16 x 2 alphanumeric character LCD with backlighting for easy viewing.  
**Pool and Spa status display:** While the SunTouch Control System is in normal day-to-day operations, the main status screen will toggle between the pool (or spa) set (and actual) temperature, and the current air temperature (if an air sensor is installed, see page 24 for details). The current system time is displayed on the lower left side of the screen. The heating source (if enabled) is displayed on the lower right side of the screen. To switch the pool circuit on and display the pool temperature, the pool circuit must be set to “On” (see Circuit On/Off Menu (1/14) on page 13 for details). To activate the Spa, press the Up arrow button to view the current Spa temperature. For more information about the spa Up arrow button, see page 3.

- ②  **MENU button:** Use the MENU button to access the Main Menu items. There are 14 menu items to select from. Press the MENU button to view each of the 14 menu items. The Main Menu items are displayed along with its menu number (1/14). Use the Menu button to scroll through the 14 menu items. To exit a menu item at any point, press the Left button to return to the main status screen. If no menu activity is detected after five minutes, the main screen is displayed. All menu settings are permanently saved and retained in the control panel even after power is removed from the control panel. For descriptions of the Main Menu items using “Pool/Spa” mode see page 13.
- Main Menu 1/14**  
**Circuit On/Off**

## Control Buttons (Continued)



(-)TEMP



(+)TEMP

**Left button:** While in the Main menu, use the Left arrow button to exit the main menu and return to the Main status screen.

**Right button:** While in the Main menu, use the Right arrow button to select a setting or parameter, or scroll through the available selected menu items. To exit the Main menu, press the Left arrow button.

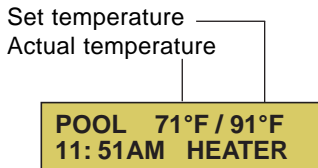

**(-)TEMP) and (+)TEMP button temperature controls:** When in Pool or Spa mode, press the (-) TEMP button to lower set temperature or the (+) TEMP button to raise the set temperature for the pool or spa water. *Note: The pool filter pump circuit must be switched on to display the current pool temperature settings. “HEATER” is displayed on the lower line of the main screen indicating the current heat source is switched on (enabled). For more information about selecting a heat source, see the “Selecting a Heat Source” on page 10. For information about switching on the filter pump circuit, see “Main Menu: Circuit On/Off (1/14)” on page 13. These buttons are only used in Pool/Spa mode. For information about Pool/Spa mode, see page 9.*



**Up and Down arrow button:** While in the Main Menu, use the Up and Down arrow buttons to adjust or change a menu item parameter or setting. The Up button increases a value, or toggles a setting. The Down arrow button decreases a value, or toggles a setting. After changing a menu item setting or value, it is automatically saved.



SPA

SPA 71°F / 91°F  
11: 51AM HEATER

**SPA (Up arrow button):** Use this button to switch the spa on and off. When the spa is activated, the main screen will display the actual and set point temperature setting. Press this button to activate the filter pump and rotate the valves and circulate pool water to the spa. To enable heat for the spa when this circuit is switched on, either switch on the heat source or switch on *Manual Heat* from the Heat menu. HEATER (or SOLAR) is displayed when the heat source is enabled. If the Spa button is pressed, while the filter pump is active (see page 13 to enable the pool filter pump), the spa valves will rotate to circulate water to the spa. When the Spa (Up arrow) button is pressed to switch the spa off, the filter pump will rotate the valves to circulate water to pool and continue to operate in pool mode. The Spa button function is only used in Pool/Spa mode. For information about Pool/Spa mode, see page 9. *Note: For Single Body systems, the UP arrow button is used for the HI-TEMP/LO-TEMP temperature control. For more information about the HI-TEMP/LO TEMP button temperature control, see page 40.*



AUX 1

AIR 71°F  
11: 51AM AUX 123

AIR 71°F  
11: 51AM AUX D23

**AUX 1 (Down arrow On/Off button):** Use the AUX 1 (Down arrow) button to manually switch the AUX 1 relay output on and off. You can also switch AUX 2, and AUX 3 on and off from the “Circuit On/Off menu. The number 1, 2, and 3 will be displayed on the main screen when the auxiliary circuits are switched on. The AUX 1, AUX 2 and AUX 3 functions are only used in “Pool/Spa” mode. For information about “Pool/Spa” mode, see page 9.

*Note: In the example shown (left), AUX D is displayed, indicating that AUX 1 is currently in “delay” mode and is not yet active. The same applies when AUX 2 or AUX 3 are in “Delay” mode. See “Assigning Circuit Functions” on page 26 for more information.*

## SunTouch® Control System Main Status Screen (Solar Only)

The SunTouch® Control System “Solar Only” main status screen display description is given below.

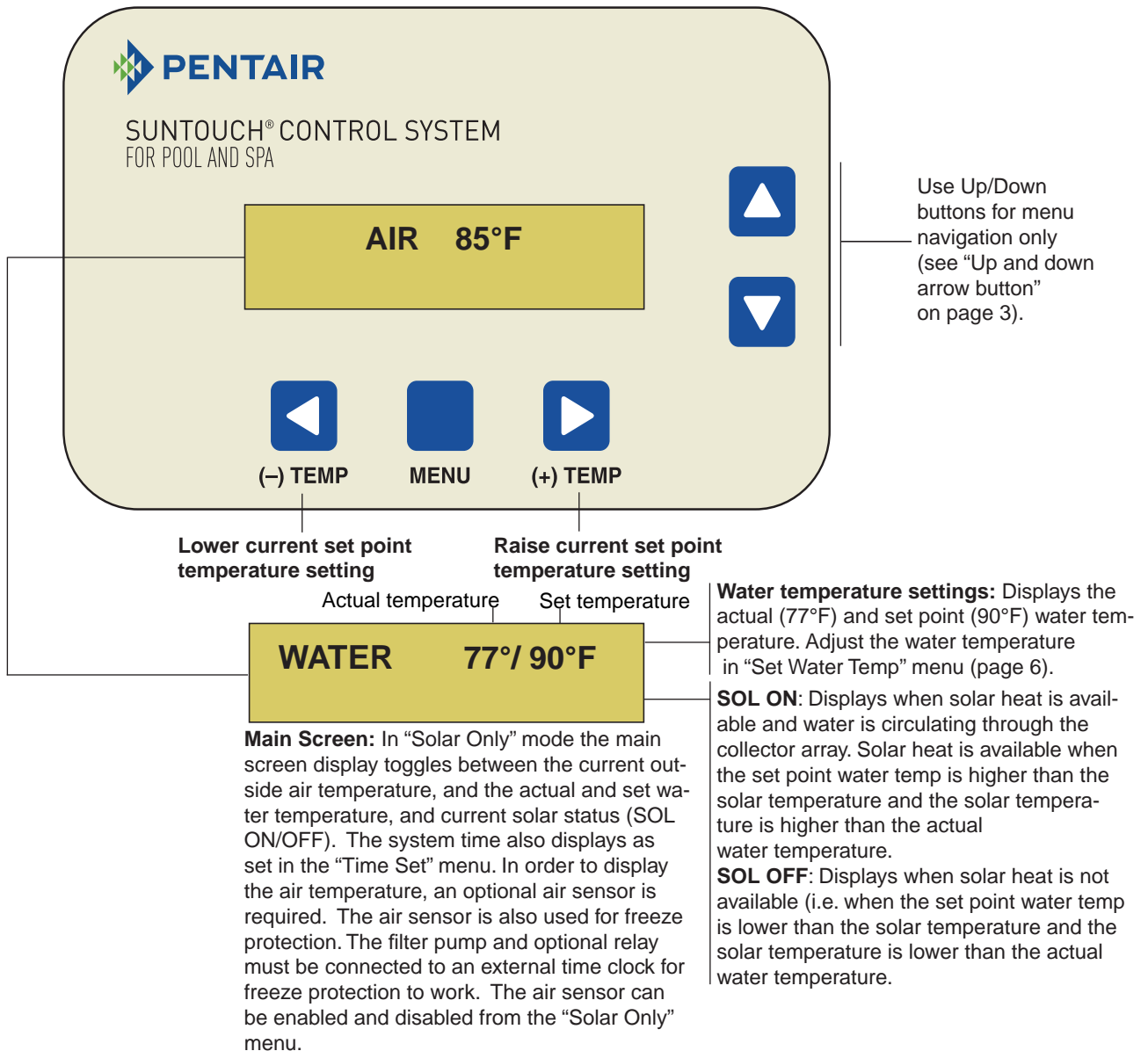

SunTouch® Control System Control Panel (Solar Only mode)

## Solar Only System

The SunTouch® Control System “Solar Only” system is factory set and ready to operate. From the main menu you can adjust the water temperature setting, set the start and stop differential temperatures, and set the solar and cleaner freeze protection feature. If additional features are required, such as a solar booster pump, you can access the “Pool/Spa” mode (shared equipment) menu features. For more information about these modes, refer to “Solar Only Menus,” on page 6, and “Pool/Spa Mode Menus (Shared Equipment)” on page 12.

## Operating in Solar Only Mode

### Solar Only mode

In “Solar only” mode, you can control your solar system to heat your pool and spa. From the control panel you can set the desired temperature setting. After the temperature is reached, the solar system is automatically switched off.

### Solar Only auxiliary outputs (Filter pump, booster pump, cleaner and time clock)

**Filter pump:** In “Solar Only” mode, the Filter pump is controlled externally by the time clock, which ensures the Filter pump is running before the Booster pump switches on.

**Booster pump:** To increase water flow through the collector array, a high voltage booster pump can be used in addition to the main Filter pump. The Booster pump will switch on at the same time as the Filter pump, assuming solar heat is available. When using a Booster pump, connect it to the AUX 1 relay in the SunTouch® Control System Power Center. For SunTouch Control System solar booster kit (P/N 520857) information, see page 43.

- Pump output on the SunTouch Control System motherboard is on whenever solar heat is available and off whenever Solar heat is *not* available
- AUX 1/Booster pump is on whenever Solar heat is available and off whenever solar heat is *not* available
- AUX 2 (Cleaner): The cleaner is off for five minutes when solar heat is detected.

### Pool/Spa Mode

In Pool/Spa mode you can fully automate your pool and spa, pool only or spa only operations. The additional menu features let you create customized schedules for your pool and spa equipment, heat temperatures, and chlorination settings to switch on and off at a set day and time. For maintenance and service purposes, the control panel allows manual control of all pool and spa operations. For information about Pool/Spa mode, see page 9.

## Setting up SunTouch® Control System for Solar Only Mode from Pool/Spa mode

To change the system to “Solar Only” mode while in Pool/Spa mode:

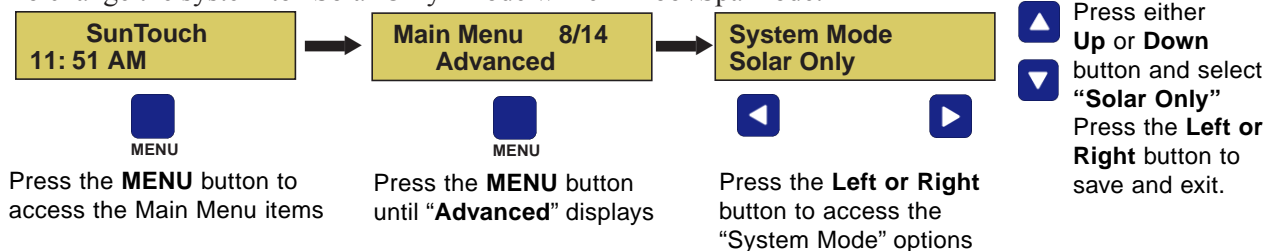

To continue to set the solar heat settings, press the **LEFT** or **RIGHT** arrow button to enter the solar water temperature settings.

**Note:** If the system is configured to operate as a “SOLAR ONLY” controller, all solar features are provided in the “Solar Only” menu settings (see page 6) with the exception of changing the degree units from Fahrenheit to Celsius (see page 22), and the Service operating features, which can be changed in the “Pool/Spa” mode menu (see page 9 for more information).

## Solar Only Menus

The Solar Only Mode menus are shown below:

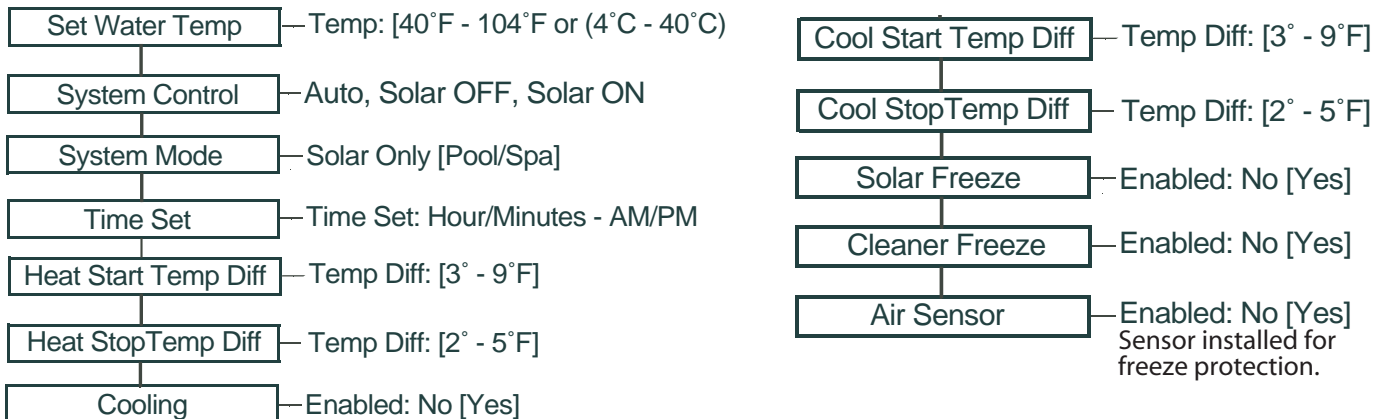

### Adjusting the water temperature setting (Solar Only mode)

If you have already set the pool and spa water temperature in the “SET WATER TEMP” menu and you need to adjust the water set point temperature, use the (-) **TEMP** or (+) **TEMP** buttons to adjust the water temperature.

- Press the (-) **TEMP** or (+) **TEMP** button to lower or raise the set temperature to the desired level. The water temperature can be adjusted from 40° F to 104° F (4° C to 40° C). When solar heat is available SOL ON is displayed on the lower display line. SOL OFF is displayed if solar heat is not available (OFF). Degree units are displayed in either Fahrenheit or Celsius (see page 22). *Note: To display the air temperature setting on the main screen, verify that the air sensor is enabled in the Main menu, see “Advanced Menu,” on page 24.*

Current air temperature (displays if optional air sensor is enabled in the Solar Only menu)

AIR 59°F  
11: 51 AM



Actual temperature ——— Set temperature

WATER 71°F / 91°F  
11: 51AM SOL ON

Solar heat is available

Lower water set point temperature

Raise water set point temperature

## Solar Only Menus

The following Main Menu features are available when the SunTouch® Control System is configured in “Solar Only” mode. The main menu features are as follows:

### Set Water Temperature

To set the water temperature:

Set Water Temp  
Temp: 81°F

**Menu button:** The Set Water Temp menu is displayed.

**Up/Down button:** Adjust to the desired set temperature from 40° F to 104° F or (4° C to 40° C). This allows the solar system to heat the water up to set point temperature. After the set point temperature is reached, the solar system is automatically switched off. To determine your optimum water temperature setting, set the “Set Temperature” settings to 100° F and observe the water temperature over a period of a few days. When the maximum desired temperature of the pool is reached, set the temperature again. Once this setting is identified, it will not be necessary to change the set temperature again.

**Left button:** Press the Left button to return to the main status screen.

**Menu button:** Press the Menu button to enter the “System Mode” menu. From this menu you can change the system from “Solar Only” mode to “Pool/Spa” mode.

## Solar Only Menus (Continued)

### System Control

Use this feature to operate the SunTouch® Control System solar system in “AUTO” mode, or manually switch solar on or off.

**System Control  
AUTO**

**Menu button:** The Set Water Temp settings is displayed.

**Right button:** Press the button to display the “System Control” setting.

**Up/Down button:** The selections are:

**AUTO:** Automatically switch the system on whenever solar energy is available. Use “AUTO” for normal operation and adjust the desired temperature setting for the pool, spa. In “AUTO” mode, the system will heat the pool or spa (rotate the valve to solar position or turn on a booster pump) when solar heat is available and the “Set Water Temp” is set higher than the water temperature. The solar temperature start and stop differential settings are factory set at 6° and 3°. The solar roof sensor must be 6° higher than the water temperature. The pump must be ON for a few minutes for operation. When the roof sensor and the water temperature are within 3°, solar heat will switch off. This differential setting is adjustable in the “Stop Temp Diff” menu setting. See your solar service professional for the optimum setting.

*Note: The filter pump timer must be set so that the filter pump operates during the time of the day when solar energy is available.*

**SOLAR ON:** Manually switch the solar system on regardless of solar energy being available. This position should be used only to test the solar system operation.

**Note: Pool Pressure Cleaner Delay:** Whenever the solar system is turned on, an electronic delay automatically turns off the pool pressure cleaner for five minutes. This protects the pump from damage caused by air in the solar panels at system start-up. The pressure cleaner is connected to AUX 2 which will be always set to on.

**SOLAR OFF:** Manually switch the solar system off.

**Left button:** Press the Left button to return to the main status screen.

### System Mode

This feature allows you to configure the system to operate in “Solar Only” mode or in “Pool/Spa” mode. For more information about Pool/Spa mode, see page 9.

**System Mode  
Solar Only**

**Menu button:** The Set Temp settings is displayed.

**Right button:** Press the button until the System Mode setting is displayed.

**Up/Down button:** Select Solar Only for solar mode, or Pool/Spa mode.

**Left button:** Press the Left button to return to the main status screen.

**In Solar Only  
Mode**

**Note:** If the Menu button is pressed while in the Solar Only menu, “In Solar Mode Only” is displayed, then the System Mode menu is displayed. If necessary, you can change the system from Solar Only to Pool/Spa mode.

### Time Set

The SunTouch Control System time is displayed on the main screen. To set the SunTouch Control System time.

**Time Set  
02:25 PM**

**Menu button:** The Set Temp settings is displayed.

**Right button:** Press the button until the Time Set setting is displayed.

**Up/Down button:** Set the hour in your location. Note the AM or PM setting.

**Right button:** Move to the minutes setting.

**Up/Down button:** Set the minutes.

## Solar Only Menus (Continued)

**Heat Start and Stop Temp Differentials:** Use this feature to adjust the start and stop temperature differential settings to start and stop solar water heating.

Heat Start Temp  
Temp Diff: 6°

Heat Stop Temp  
Temp Diff: 3°

Press **Menu button** the Solar Status setting is displayed. Press **Right button** until the “Start Temperature Differential” setting is displayed. Press **Up/Down button** to adjust “Heat Start Temp” differential setting (default setting 6°). Press **Right button** to move to the “Heat Stop Temp” setting. Press **Up/Down button** to adjust “Heat Stop Temp” differential setting (default is 3°). This setting sets how close to the target set point temperature to switch off solar heat. Press **Left button** to return to the main status screen.

*Note: The solar roof sensor must be 6° higher than the water temperature. The pump must be ON for a few minutes for operation. When the roof sensor and the water temperature are within 3°, solar heat will switch off. This differential setting is adjustable in the “Stop Temp Diff” setting. Adjusting the differential will effect the performance of your solar system. See you solar professional for the optimum setting.*

## Cooling (Enabled) and Start and Stop Temp Differentials:

When “Cooling” is enabled, water will circulate through the system to lower the temperature during the night hours. Adjust the “Cool Start and Stop Temp differential temperatures settings.

Cool Start Temp  
Temp Diff: 6°

Cool Stop Temp  
Temp Diff: 3°

**Solar Freeze protection:** Use this feature to enable freeze protection for the solar equipment.

Solar Freeze  
Enabled: Yes

**Menu button:** The Set Water Temp setting is displayed.

**Right button:** Press the button until the Solar Freeze setting is displayed.

**Up/Down button:** Select **Yes** to enable solar freeze protection or **No** to disable freeze protection. If **Yes** is selected, the circuit will switch on if the air temperature drops to 36° F (2° C). This feature is used to protect the system plumbing from being damaged during freezing conditions. *Note: When freezing conditions are detected by the air sensor, the filter pump will be switched on and water will circulate continuously through the system.*

**Left button:** Press the Left button to return to the main status screen.

**Cleaner Freeze protection:** Use this feature to enable freeze protection for cleaner equipment.

Cleaner Freeze  
Enabled: Yes

**Menu button:** The Set Water Temp setting is displayed.

**Right button:** Press the button until the Cleaner Freeze setting is displayed.

**Up/Down button:** Select **Yes** to enable cleaner freeze protection or **No** to disable freeze protection. If **Yes** is selected, the circuit will switch on if the air temperature drops to 36° F (2° C). This feature is used to protect the cleaner equipment from being damaged during freezing conditions. *Note: When freezing conditions are detected by the air sensor, the filter pump will be switched on and water will circulate continuously through the system.*

**Left button:** Press the Left button to return to the main status screen.

*Note: Air Sensor (freeze protection requirement): Freeze protection for solar systems (“Solar Only” mode) requires an optional ambient air temperature sensor and relay for the filter pump and or cleaner pump override. See page 81 for Time clock pump override information. The air sensor must be enabled to display the current air temperature on the main status screen. The optional air temperature sensor is used to protect the system plumbing and equipment against freeze damage. For information about freeze protection for circuits, valves and auxiliaries, see page 9. To enable or disable the air sensor:*

Air Sensor  
Enabled: Yes

**Menu button:** The Set Water Temp setting is displayed.

**Right button:** Press the button until the Air Sensor is displayed.

**Up/Down buttons:** Select **Yes** to enable the sensor. Select **No** to disable the sensor (and not display the air temperature on the main status screen).

**Left button:** Press the Left button to return to the main status screen.



## Freeze Protection in Solar Only mode

The SunTouch® Control System freeze protection function is active once the optional air sensor is installed and enabled (see page 8). Freeze protection is enabled whenever the outside temperature is 36° F or lower. When freezing conditions are detected by the air sensor the filter pump will be switched on and water will circulate continuously through the system. It's important that the air sensor be permanently placed in the shade and away from windy locations. In the event of a power failure, the system will be unprotected. Recirculating water to protect your system from freezing is not recommended in climates where freezing temperatures occur frequently and last for extended periods.

**CAUTION** *If you live in a location where freezing conditions occur and there is no air sensor installed or the air sensor is not enabled, your system will be unprotected.*

## Operating in Pool/Spa mode (Shared Equipment)

### Pool/Spa Mode

Using the SunTouch Control System in the Pool/Spa mode allows pool and spa operations to be fully automated. The menu features let you create customized schedules for your pool and spa equipment, heat temperatures and chlorination settings to switch on and off at a time and day. For maintenance and service purposes, the control panel allows manual control of all pool and spa operations.

### Setting up the SunTouch® Control System to Operate in Pool/Spa Mode

To setup the SunTouch® Control System to operate in Pool/Spa mode (shared equipment):

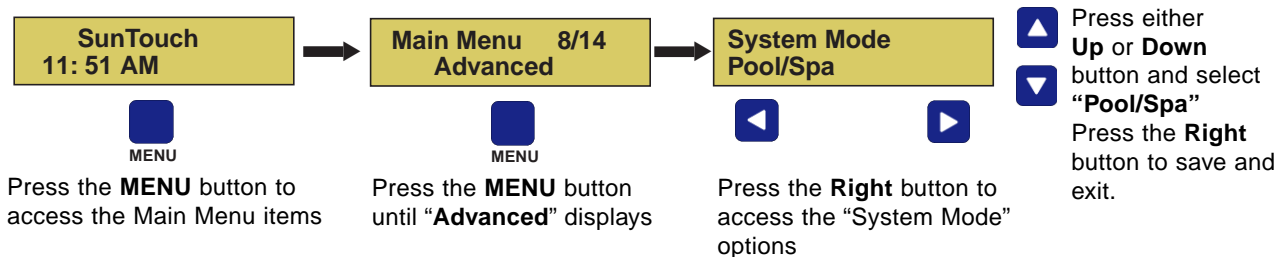

Press the **LEFT** arrow button to save and exit the main menu. *Note: For the Pool/Spa menu settings, see page 12.*

### Adjusting the Water Temperature Setting in Pool/Spa Mode

After setting the pool water temperature in the Heat menu (see page 14), you might occasionally need to adjust the water set point temperature. Use the (-) **TEMP** and (+) **TEMP** buttons to set the water to the desired temperature.

**To adjust the spa set point water temperature:** Press the **Spa (Up arrow)** button to display the actual and set point water temperature settings. As shown below, the heat setting displayed on the left side (71° F) is the actual water temperature and on the right side the set point temperature (91° F) is displayed. The set point temperature is set in the Heat menu. *Note: For Information about selecting the heat source, refer to “Selecting the Heat Source” on page 10.*

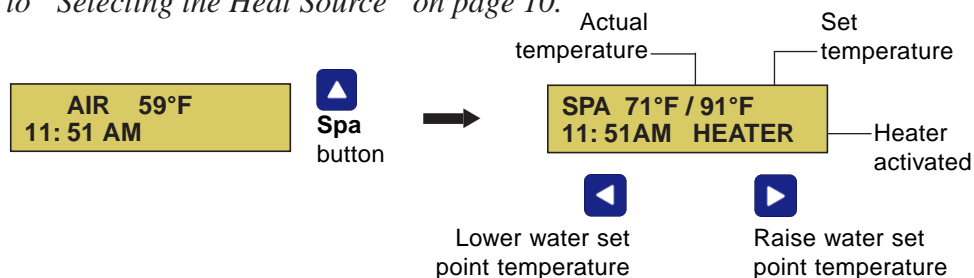

## Adjusting the water temperature setting in Pool/Spa mode (Continued)

- **Adjusting the pool water temperature:** To display the pool water temperature settings, first activate the “Pool” circuit. To activate the circuit, press the **MENU button**, then press the **RIGHT arrow button**, then press the **Up or Down** arrow button. The pool water temperature settings are displayed.
- Press the **Left or Right** button to adjust the pool water set temperature. The currently selected heat source is displayed on the lower display line. The spa water temperature can be adjusted from 40° F to 104° F (4° C to 40° C). Degree units are displayed in either Fahrenheit or Celsius (see page 22).

*Note:* To display the air temperature setting on the main screen, the air sensor must be enabled. For more information see “Advanced Menu,” on page 24.

## Selecting the heat source

From the Heat menu you can set the spa and pool water temperature and select the heat source. The spa or pool water will heat to the settings specified. The SunTouch® Control System is compatible with solar and conventional heaters. The SunTouch control system will use the heating source that is selected.

To select the heat source:

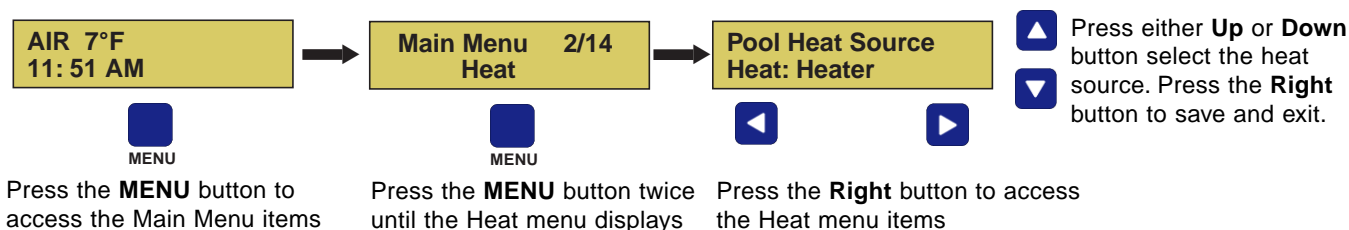

The heat source selections are:

- **OFF** - No heating, even though the filter pump and other circuits may be operating.
- **HEATER** - Use the UP arrow button to switch the filter pump then the heater on. Once the heater is switched on it will continue heating the water until the heater’s current highest set point temperature triggers the heater sensor (approximately 104° F or 40° C). Note that setting the “Heat Source” to “Heater” does not activate the filter pump. The filter pump must first be switched on before the heater switches on. The heater will not run if water flow is not detected. Do not activate the heater without running the pump.
- **SOLAR** - Solar heating system selected as the only heat source. Solar heat can be switched on and off in the “Solar” menu (see page 19). When solar energy is active the solar relay is switched on to activate the booster pump (if installed) and rotate the valves to divert water through the solar collector panels.
- **SOLAR PREF.** - (Solar Preferred) - Used when solar and gas heating are combined. This feature uses solar heating energy when it is most effective, then switch to gas heating when solar heating is not available. In order to display “Solar Pref.” on the main screen, enable “Solar” in the Solar menu.

*Note: Solar Only mode* - If a solar heating system is the only heat source, enable solar in the “Solar” menu (see page 19).

## Main Status Screen (Pool/Spa mode - Shared Equipment)

Use the SunTouch® Control System display to view daily pool and spa operations. The “Schedule” menu feature (page 17) is typically used for these operations. For manual spa operation, pressing the SPA Up button will activate the spa circuit, switch on the filter pump, display the current spa water, air temperature setting, and heat source. To activate the pool circuit and activate the filter pump, display the current pool water and air temperature, and heat source, set the menu feature “Circuit On/Off” to “ON.” If the AUX 1 (Down arrow) button is assigned to a light circuit, use this button to manually switch the lights on/off. Lights and other installed equipment are setup from the “Circuit Function” menu (page 26). Before using the SunTouch Control System, familiarize yourself with the status screen and control buttons.

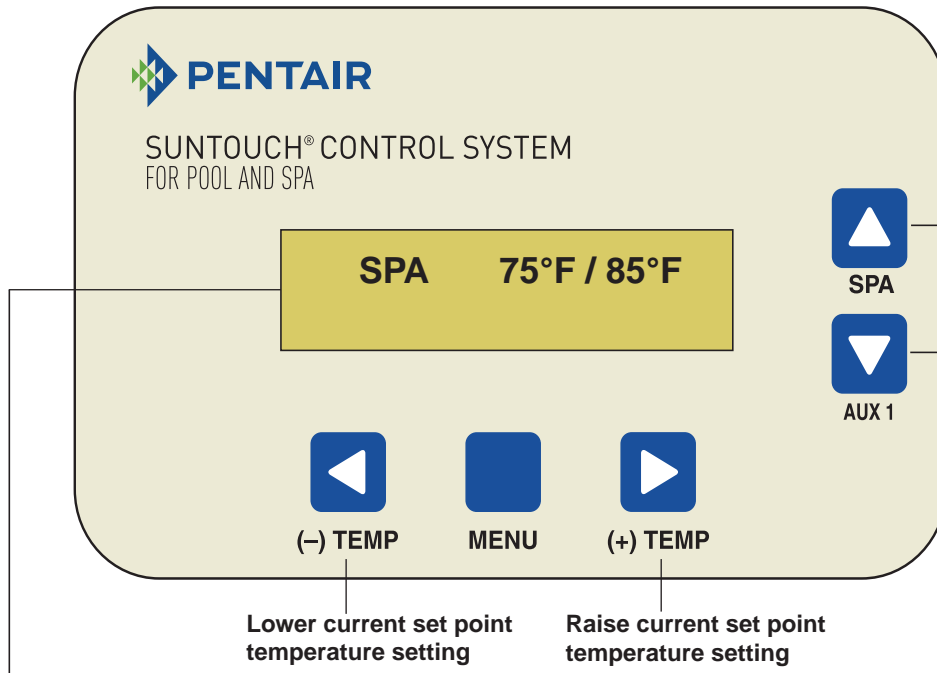

**Spa button:** Switch the spa on and off and display current temperature settings. Press this button to activate the filter pump and rotate the valves and circulate pool water to the spa. To enable heat for the spa when this circuit is switched on, either switch on the heat source or switch on “Manual Heat” from the “Heat” menu.

**AUX 1 button:** Press this button to manually switch on the AUX 1 relay (number 1 is displayed). AUX 1 can be assign to operate accessory equipment such as pool and spa lights.

**Note:** For information about **HI-TEMP (UP arrow button)** circuit controls for single body systems, see page 39.

**AIR 77°F FRZ  
11: 51AM AUX 1**

**AIR:** Displays the outside ambient air temperature via the air sensor located near the pool area. To display the air temperature setting, the air sensor must be enabled (see “Advanced” menu, page 24). The main status screen toggles between the pool, spa and air temperature settings. Degree units are displayed in either Fahrenheit or Celsius. If the top display line displays “SunTouch”, no spa or pool function is active and air sensor is not enabled.

**AIR 77°F FRZ  
11: 51AM AUX 1**

**FRZ:** Indicates the air sensor is connected and enabled, and freeze protection is active (see page 26).

**POOL 75°F / 85°F  
11:51AM HEATER**

**SPA/POOL:** Press the SPA (Up arrow) button to display the current spa water temperature settings. If the pool filter pump is switched on from the “Circuit On/Off” menu or a programmed schedule, “POOL” is displayed with the current pool water temperature settings. “SPA” and “POOL” are displayed alternatively if both are active. The filter pump will switch off while the pool/spa valves are rotating into position. For information about **HI-TEMP/LO-TEMP** controls for this button (single body system) see page 39.

**HEATER:** Displays the heat source (**Heater, Solar Prf., Solar**) being used as specified in the “Heat” menu settings (see page 14). If heat is enabled, when the pool filter pump is switch on, the heat source is displayed.

**75° F / 85° F:** Displays the actual spa or pool water temperature (75° F) and the set point temperature (85° F) as set in the “Heater” menu (see page 14). To adjust set temperature setting use the (-) TEMP and (+) TEMP buttons.

**Time:** Displays the SunTouch Control System time as set in the “Clock” menu setting (see page 19).

**AIR 77°F  
11: 51AM AUX 123**

**AUX 1 2 3:** Displays AUX 1, 2, 3 (lower line) when these auxiliary relay circuits are switched on. Press the AUX 1 (1) button to manually switch auxiliary 1 on or off. AUX 2, and AUX 3 can be switched on and off manually from the “Circuit On/Off” menu (page 13). Auxiliary functions are assign in the “Circ. Function” menu (page 26).

**AIR 77°F  
11: 51AM AUX D**

**AUX D:** “D” indicates the selected circuit (AUX 1,2,3) is in “delay” mode. For example, if AUX 2 is assigned to a cleaner, when the auxiliary circuit 2 is switched on via the “Circuit On/Off” menu setting, this will force the filter pump on for five (5) minutes before the cleaner pump switches on. See “Circuit Functions Menu” (page 26) for more information.

## Pool/Spa Mode Menus (Shared Equipment)

<b>Circuit On/Off</b> 1/14	<b>Filter Pump:</b> [Circuit On/Off - <b>POOL: On/Off</b> ] - Default Off (page 13)
<b>Heat</b> 2/14	<ul style="list-style-type: none"> <li><b>POOL Temp</b> [40° F - 104° F] or [4° C - 40° C] (page 14)</li> <li><b>POOL Heat</b> (Source) [Off, Heater] [Solar, Solar Prf - displays if "Solar" is enabled in "Solar" menu] (page 19)</li> <li><b>SPA Temp</b> [40° F - 106° F] or [4° C - 41° C]</li> <li><b>SPA Heat</b> (Source) [Off, Heater] [Solar, Solar Prf - displays if "Solar" is enabled in "Solar" menu] (page 19)</li> <li><b>Manual Heat:</b> [ON/OFF] - Default On (page 15)</li> </ul>
<b>Delay Cancel</b> 3/14	<b>Press Right button to cancel delays</b> - [Delayed Cancelled] (page 16)
<b>Schedules</b> 4/14	<ul style="list-style-type: none"> <li><b>Schedules:</b> [Pool, Spa, AUX 1 - 3, FT 1 - 4] (page 17)</li> <li><b>Program:</b> 4/4 [Add, Edit, Skip, Delete]</li> <li><b>Schedule:</b> Start/Stop [08:00A - 05:00P] 12:00 AM - 11:59 PM - 12 Hours</li> </ul>
<b>Clock</b> 5/14	<b>Time Set:</b> 06:00 AM [Hour/Minutes - AM/PM] (page 19)
<b>Solar</b> 6/14	<ul style="list-style-type: none"> <li><b>Solar Status:</b> Enabled [NO / YES] - Default No (page 19 - 20) - <b>Solar Freeze:</b> Enabled: [Yes/No]</li> <li><b>Heat Start Temp Diff:</b> Temp Diff [6°] - [6-9°] - <b>Heat Stop Temp Diff:</b> Temp Diff [3°] - [3-5°]</li> <li><b>Heat Pump:</b> [Yes/No] - Default No - <b>Cooling Enabled:</b> [Yes/No] -</li> <li><b>Cool Start Temp Diff:</b> Temp Diff [6°] - <b>Cool Stop Temp Diff:</b> Temp Diff [3°]</li> </ul>
<b>Valves</b> 7/14	<b>Valves Circuit:</b> [SPA, POOL, AUX1 - 3, FEATURES 1 - 4, SOLAR, HEATER, FREEZE, NONE] (page 21) [SOLAR displays if "Solar" is enabled] (page 19)
<b>Advanced</b> 8/14	<ul style="list-style-type: none"> <li><b>Heater Delay:</b> Enabled [No/Yes] (page 22) - <b>Valve Delay:</b> Enabled [No/Yes] (page 22)</li> <li><b>Temp Units:</b> [FAHRENHEIT / CELSIUS]</li> <li><b>Calibrate Water:</b> Temp 10° F - <b>Calibrate Air:</b> Temp 90° F - <b>Calibrate Solar:</b> Temp 100° F -</li> <li><b>Air Sensor:</b> [Yes/No] - (Default Yes) - See page 24 - <b>System Mode:</b> [Pool/Spa, Solar Only*]</li> <li><b>System Type:</b> [Shared Equipment, Single Body] - <b>Circuit Timeout:</b> 12 hours [1 - 23 Hours]</li> <li><b>Reset Factory:</b> [Erase ALL? (No/Yes)]</li> </ul>
<b>Diagnostics</b> 9/14	<ul style="list-style-type: none"> <li><b>Firmware Rev:</b> System firmware revision level (page 25) - <b>Solar Temp:</b> [Fahrenheit/Celcius - Status display only]</li> <li><b>Self Test:</b> [Yes/No] - <b>IntelliChem:</b> pH and ORP status.</li> </ul>
<b>Circ. Functions</b> 10/14	<ul style="list-style-type: none"> <li><b>Pool Circuit:</b> Freeze [Off/On] - Default Off - see page 26 - <b>Spa Circuit:</b> Freeze [Off/On]</li> <li><b>AUX 1 - 3 Circuit:</b> [Generic, Cleaner, Spillway, Floor Cleaner, Heater, Solar] - <b>Freeze:</b> [Off/On]</li> </ul>
<b>QuickTouch</b> 11/14	<ul style="list-style-type: none"> <li>QuickTouch - Assign 1 - 4 circuits (page 28)</li> <li><b>Button 1, 2, 3, 4</b> [Spa, Pool, AUX 1 - 3, FEATURE 1 - 4, Heat Boost, Heat Enabled, None]</li> </ul>
<b>Pumps</b> 12/14	<ul style="list-style-type: none"> <li><b>SINGLE SPEED - TWO SPEED - INTELLIFLO VS - INTELLIFLO VSF - INTELLIFLO VF</b> (page 29 - 32)</li> <li><b>TWO SPEED - Pump Circuits 1-4:</b> [Spa, Pool, AUX1- 3, FEATURE 1 - 4, Solar, Heater, Pool Heat, Spa Heat, Freeze, Pool/Spa, Solar/HT]</li> <li><b>INTELLIFLO VS - Circuit Setup (1-8):</b> [Spa, Pool, AUX1- 3, FEATURE 1 - 4, Solar, Heater, Pool Heat, Spa Heat, Freeze, Pool/Spa, Solar/HT, None] 1-8 - RPM 1000 default [400 - 3450] - <b>Assign Speeds (1-8):</b> RPM 1000 default [400 - 3450 RPM]</li> <li><b>INTELLIFLO VF - Circuit Setup (1-8):</b> [Spa, Pool, AUX 1 - 3, FEATURE 1 - 4, Solar, Heater, Pool Heat, Spa Heat, Freeze, Pool/Spa, Solar/HT] - <b>Assign Flows: (1-8)</b> GPM 30 default [15 - 130 GPM] -</li> <li><b>INTELLIFLO VSF - Pump Params Menu: CIRC. SETUP (1-8)</b> [None, Spa, Pool, AUX1 - 3, FEATURE 1 - 4, Solar, Heater, Pool Heat, Spa Heat, Freeze, Pool/Spa, Solar/HT] - GPM/RPM mode: GPM/PSI [15 - 130 GPM - PSI: Disable/1-30], RPM 1000 default [400 - 3450 RPM]</li> </ul>
<b>IntelliChlor</b> 13/14	<ul style="list-style-type: none"> <li><b>IntelliChlor:</b> Enable [No / Yes] (page 32)</li> <li><b>Pool %:</b> (0% - 100%) - 50 (Default) - <b>Spa %:</b> (0% - 100%) - 8 (Default)</li> <li><b>Super Chlr:</b> (No/Yes) - 23 (Default) - <b>Run Hours:</b> (0 - 72) - 0 (Default)</li> <li>IntelliChlor - <b>Salt Level:</b> Displays current salt level (xxxx) ppm - <b>Status:</b> OK - NO ERRORS (SUPER CHLORINATE, COM LINK ERROR, CHECK FLOW / PCB, LOW SALT, VERY LOW SALT, HIGH CURRENT, CLEAN CELL!!, LOW VOLTAGE)</li> </ul>
<b>Service</b> 14/14	<b>System Operation:</b> [AUTO, TIMEOUT, SERVICE] (page 35) - <b>Service Settings: F Pump:</b> On/Off, HI SPD - <b>VLV A, B:</b> Pool, Drain, Fill, Spa - <b>Heater:</b> Off/On, AUX 1 - 3, <b>VLC:</b> (On/Off) - AUTO - [Solar On/Off - only]

Note: (\*) See page 6 for "SOLAR ONLY" menu.

## Pool/Spa Mode Menus

The following describes the 14 “Pool/Spa mode” menus. Displayed on the Main Menu screen is the menu description and the menu number (1/14).

### Circuit On/Off Menu (1/14)

Use the “Circuit On/Off” menu feature to manually switch ON/OFF the pool filter pump, auxiliary circuits (AUX 1-3) and feature circuits (FT. 1-4). Switching circuits on or off will override any programmed schedules that might already be assigned to these circuits. For more information about schedules, see “Schedules Menu” on page 17.

**POOL FILTER PUMP ON/OFF:** Use the “Circuit On/Off” Pool setting, to manually switch the pool filter pump relay on or off. When the pool filter pump switched on, the valve actuator will rotate to isolate the pool water from the spa water, and switch the heater on (if enabled in the “Heat” menu). When this circuit relay is switched on manually, it remains on until either you switch it off manually or the default 12 hours has elapsed. The system default 12 hours can be changed from 1 to 23 hours (see “Circuit Timeout” page 24). For example, if the filter pump is scheduled to automatically run from 9:00 AM to 5:00 PM daily, then the filter pump is switched on manually at 9:00 PM, it will run continuously until the next day at 5:00 PM then switch off. The schedule will then continue from then on. The top display line on the main status screen will alternately display the current water temperature and the current air temperature (if the air sensor is enable, see page 24 for details). If the pool filter pump is on, and the spa is switched on using the Up arrow button, the main status screen will alternately display the current water temperature between “Pool” and “Spa” mode. For HI-TEMP, LO-TEMP controls (SunTouch® Control System single body system), see page 40.

Main Menu 1/14 Circuit On/Off
Circuit On/Off Pool: ON
Pool 77°F / 79°F 9:45 AM HEATER

**Menu button > Right arrow button:** Select **Circuit On/Off (1/14)**.

**Up/Down arrow button:** Press the Up or Down button to toggle the POOL pump circuit **ON or OFF**. After switching the Pool filter pump ON, the main status screen displays the current pool water temperature. To adjust the set point temperature, use the Left and Right arrow buttons.

**Right arrow button:** Select the “Circuit On/Off” Pool On/Off setting. Use this function to manually switch the pool filter pump on or off.

*Note: The Solar auxiliary relay (Valve C) on the SunTouch Control System motherboard can operate a solar booster pump which will switch on when the filter pump is running. Solar heat must also be available and the water must be below the set point temperature setting. For more information, see “Solar Menu” on page 20.*

**Left arrow button:** Press the Left button to return to the main status screen.

**AUX 1, AUX 2:** Use this feature to manually switch the auxiliary relay output circuit on or off. These auxiliary circuits can be assigned to operate the pool and spa system valves, lights and other equipment. When the AUX 1 or AUX 2 circuit relay is switched on manually, it remains on until either you switch it off manually, the default 12 hours has elapsed.

Main Menu 1/14 Circuit On/Off
Circuit On/Of AUX 2: ON
AIR 71°F 11: 51AM AUX D3

**Menu button > Right arrow button:** Select the **Circuit On/Off 1/14** menu to manually switch AUX 1, AUX 2 relay ON or OFF.

**Right arrow button:** Press the **Right arrow button** until AUX 1, AUX 2, or AUX 3 is displayed.

**Up/Down arrow button:** Press the **Up/Down arrow** button to toggle the AUX circuit on or off.

**Left arrow button:** Press the Left button to return to the main status screen.

**AUX 3:** AUX 3 circuit can be used as an extra assignment to control and electric heater, pump speeds or a valve actuator (see page 26 for details). For example, AUX 3 can be assigned to control the high speed function of a 2-Speed pump or one of the four speeds of the IntelliFlo® VS Pump. The pump speed control can be selected/activated via a scheduled program or switched on/off manually. You can also assign a button on the four-function QuickTouch® Wireless Remote (optional equipment) to control the high-speed pump function. *Continue on next page.*

## Circuit On/Off Menu (1/14) Continued

Pool 77°F / 79°F  
9:45 AM AUX 1

To return to the menu items, press the Left button. *Note: AUX 1 relay circuit can also be switched on or off using the control panel **Down Arrow button**. When the Down Arrow button is pressed to switch the AUX 1 circuit on, AUX 1 is displayed.*

**FEATURE 1 - 4:** Assigned relay output FEATURE 1 - 4 circuits can be manually switched ON or OFF from the Circuit On/Off menu. Feature circuits are assigned in the Schedule, Valves, Pumps and QuickTouch menus. When the Feature circuit relay is switched on manually, it remains on until either you switch it off manually, the default 12 hours has elapsed (see page 24 for more about changing the “Circuit Timeout” duration).

Main Menu 1/14  
Circuit On/Off

**Menu button > Right arrow button** to select the **Circuit On/Off 1/14** menu.

Circuit On/Of  
FT. 1: ON

**Right arrow button:** Press the **Right arrow button** until FT.1 (Feature circuit) is displayed.

AIR 71°F  
11: 51AM AUX D3

Press the **Up/Down arrow buttons** to toggle the FT. 1 circuit ON or OFF. Press **Right arrow button** to select the FT. 2 - 4 and repeat switch ON/OFF.

**Left arrow button:** Press the Left button to return to the main status screen.

## Heat Menu (2/14)

Use the heat menu settings to specify the set point temperature and select the heat source for the pool and spa. The water will begin to heat whenever the heater is manually switched on. To switch the heater on, press the Spa button (**Up Arrow button**) or switch the Filter Pump to “On” (see **Circuit On/Off** on page 13) even if the heater is set to off. The spa will also begin to heat when switched on by the optional QuickTouch wireless remote. The SunTouch Control System allows for solar and conventional heaters. The SunTouch Control System will use the heating source that is selected. The heat source selections are:

- **OFF** - No heating even though pump and other circuits may be operating.
- **HEATER** - Use gas heater only. Use the UP arrow button to switch the filter pump then the heater on. Once the heater is switched on it will continue heating the water until the heater’s current highest set point temperature triggers the heater sensor (approximately 104° F or 40° C). Note that setting the “Heat Source” to “Heater” does not activate the filter pump. The filter pump must first be switched on before the heater switches on. The heater will not run if water flow is not detected. Do not activate the heater without running the pump.
- **SOLAR** - Solar heating system selected as the only heat source. Solar heat can be switched on and off in the “Solar” menu (see page 20). When solar energy is active the solar relay is switched on to activate the booster pump (if installed) and rotate the valves to divert water through the solar collector panels.
- **SOLAR PREF.** - (Solar Preferred) Used when solar and gas heating are combined. This feature uses solar heating energy when it is most effective, then switch to gas heating when solar heating is not available. In order to display “Solar Pref.” on the main screen, enable “Solar” in the Solar menu (see page 20).

## POOL TEMPERATURE AND HEAT SOURCE SETTINGS

To set the POOL temperature and switch the HEATER ON or OFF:

Main Menu 2/14  
Heat

**Menu > Right arrow button:** Select the **Heat** menu.

Pool Temperature  
Temp: 75°F

**Right/Left arrow button:** Select the **POOL** temperature setting.

**Up/Down arrow button:** Adjust to the desired pool set point temperature (from 40° F to 104° F or 4° C to 40° C).

Pool Heat Source  
Heat: Heater

**Right arrow button:** Access the **POOL HEAT** source setting.

**Up/Down arrow button:** Select the heat source options: **OFF, HEATER, SOLAR PREFERRED** or **SOLAR**.

**Left arrow button:** Press the Left button to return to the main status screen.

## Heat Menu (2/14) (Continued)

### Spa Temperature and Heat Source

---

To set the SPA temperature and switch the HEATER ON or OFF:

Main Menu Heat	2/14
Spa Temperature Temp:	85°F
Spa Heat Source Heat:	Heater

**Menu > Right arrow button:** Select the **Heat** settings.  
**Right/Left arrow button:** Select the **SPA** temperature setting.  
**Up/Down arrow button:** Adjust to the desired spa set point temperature (from 40° F to 104° F or 4° C to 40° C).  
**Right arrow button:** Access the **POOL HEAT** source setting.  
**Up/Down arrow button:** Select the heat source options: **OFF, HEATER, SOLAR PREFERRED** or **SOLAR**.  
**Left arrow button:** Press the Left button to return to the main status screen.

### HI-TEMP (Up Arrow button)

For SunTouch® Control System single body systems (pool only or spa only, see page 36), the **HI-TEMP (UP arrow button)** is used to switch the heater (regardless of the Heat menu setting) and filter pump on and off. Typically this circuit is used with the “Manual Heat” feature (see below) for on-demand spa water heat. The heat temperature settings are displayed on the main screen. The heater is active when the set temperature is higher than the water temperature. The heater will switch off when the water temperature rises above the set temperature.

### LO-TEMP (Spa) Menu Operation

The LO-TEMP on and off control is made from the Heat menu setting. For SunTouch® Control System single body systems (pool only or spa only, see page 36), the LO-TEMP menu setting is used to switch on and off the heat source and filter pump. A heat selection must be selected in the Heat menu before the heater is activated. The “Manual Heat” setting does not function with the LO-TEMP circuit. The heater is active when the set temperature is higher than the water temperature. The heater will switch off when the water temperature rises above the set temperature.

### MANUAL HEAT (Off/On)

---

By default, the spa Manual Heat feature is always set to “ON.” This allows the spa to begin to heat whenever the **SPA, Up arrow button** is pressed, regardless of the heat source setting in the Heat menu (see page 4). This feature allows the spa to be filtered daily with the heater switched off. The optional QuickTouch® QT4 Wireless Remote can also be used to switch the spa heater on. This feature will not work for solar systems, only gas and electric heaters.

### MANUAL HEAT

---

To enable or disable spa heat when switched on manually:

Main Menu Heat	2/14
Manual Heat Manual Heat:	On

**Menu > Right arrow button:** Select the **Heat** settings.  
**Right/Left arrow button:** Select the **MANUAL HEAT** setting.  
**Up/Down arrow button:** Select **OFF** to disable or **ON** to automatically activate the heat when the **SPA, Up arrow button** (or **HI-TEMP button** for single body systems) is pressed regardless of the “Heat Source” setting (see page 14).  
**Left arrow button:** Press the Left arrow button to return to the main status screen.

## Delay Cancel Menu (3/14)

Use the Delay Cancel feature for service or testing purposes. Normally, there is no need to cancel any of the following delays except for servicing or testing the system. For convenience, on a onetime basis, the Delay Cancel feature will cancel the following safety delays.

- **Heater Cool-Down Delay Cancel:** Shuts Filter Pump off immediately.
- **2-Speed Filter Pump five-minute START on HIGH SPEED Delay Cancel:** Shifts pump to low speed.
- **Automatic Pool Cleaner START Delay:** Starts Cleaner Pump immediately, without normal delay in which the filter pump first runs for 5 minutes.
- **Automatic Pool Cleaner SOLAR Delay:** Allows Cleaner Pump to run even though solar delay has shut it off for 5 minutes.

Some heaters require a cool-down cycle before being switched off. This can be setup in the menu to run the filter pump an additional ten minutes to dissipate residual heat built up inside the heater combustion chamber. The Delay Cancel feature is mainly for use by service technicians when it's necessary to shut the filter pump off immediately, and know the heater has not been running. Heaters manufactured by Pentair do not require this cool-down period and do not need the delay to be set up.

### DELAY CANCEL

---

To activate Delay Cancel:

**Main Menu 3/14  
Delay Cancel**

**Menu button:** Press the Menu button until **Delay Cancel** displays (blinking on and off).

**Right arrow button:** Use the Right arrow button activate Delay Cancel for one time only. "Delay Cancelled" is displayed on the Main Menu 3/14 screen is displayed.

**Left arrow button:** Press the Left arrow button to return to the main status screen.



## Schedules Menu (4/14)

Scheduled start and stop programs can be assigned to pool, spa and auxiliary circuits (AUX 1, AUX 2, AUX 3) and FEATURE 1 - 4 functions. The start and stop times can be programmed to run automatically within a 12 hour period. The default run time for a scheduled circuit is 8:00 AM to 5:00 PM which can be adjusted in 15 minutes increments. A maximum of four scheduled programs can be setup for any one circuit, with a total of six programs for all circuits combined.

To program a circuit:

### Add a new program to a circuit

Main Menu 4/14  
Schedules

Press the **Menu > Right arrow buttons** to select the **Schedules menu** (4 of 14).

Schedule [Pool ]  
Prg: 0/0 - Add

Press the **Right button** to access the schedule settings and program an available circuit.

Schedule [Pool ]  
Prg: 1/1 - Add

Press the **Up/Down arrow buttons** to select the circuit to program. The circuits are: **POOL, SPA, AUX 1, AUX 2, AUX 3, FT 1 - FT 4**. If there existing programs assigned to circuits, use the **Up/Down arrow buttons** to scroll through the each programmed circuit.

Schedule [Pool ]  
Prg: 2/1 - Edit

Press the **Right arrow button** twice to select the mode settings (**Add, Edit Delete**). To add a program, Use the **Up/Down button** to select **Add**. Press the **Right arrow button**. **Edit** is displayed (blinks on and off) and the circuit number will increment from zero to one (1/1). At this point there are still three available circuit that can be assigned to that circuit.

#### Mode settings

- **Add:** Add up to four programs to the selected circuit.
- **Delete:** Delete the current program
- **Edit:** Move to the Start/Stop time for the current circuit program.

#### Set the start and stop time

Schedule [Pool ]  
Start: 8:00 AM

Press the **Right arrow button** to set the **START time** setting for the circuit.

Schedule [Pool ]  
Stop: 5:00 PM

Press the **Up/Down arrow button** to set the **START time** to automatically start the circuit. Adjust the start time in 15 minutes increments for AM or PM.

Main Menu 4/14  
Schedules

Press the **Right arrow button** to move to **STOP time** setting.

Schedule [FT. 1 ]  
Prg: 0/0 - Add

Press the **Up/Down button** to set the time to automatically stop the circuit. Adjust the stop time in 15 minutes increments for AM or PM.

Schedule [FT. 1 ]  
Prg: 1/0 - Edit

Press the **Right button** twice to set or edit another program (e.g. AUX 1-3 or FT. 1 - 4).

or

POOL 71°F / 91°F  
11: 51AM HEATER

Press the **Left button** to return to the main status screen.

## Schedules Menu (4/14) (Continued)

### Schedule your Spa or Pool

You can set a daily start and stop time to switch the filter pump on and rotate the pool or spa valves into the “Spa” or “Pool” position. The heater will automatically heat the spa or pool water up to the set point temperature as set in the “Heat” menu (see page 14). If the pool has a separate jet pump or blower controlled by AUX 1 and/or AUX 2, these need to be scheduled separately. You can also program when to filter and heat your pool, and switch light or auxiliary circuits on or off.

You can create schedules to automatically run equipment like pool filtration or lights. Any circuit can be set to switch on and off on every day of the week. When a relay is switched on manually, it remains on until you either switch it off manually, or the next time the relay is scheduled to be switched off. For example, if the filter pump or any circuit is scheduled to run from 9:00 AM to 4:00 PM and the programmed schedule is turned OFF at 1:00 PM and then turned on at 1:10 PM, the circuit will turn OFF at its programmed OFF time of 4:00 PM. But if the circuit is turned on after 4:00 PM, the factory set Egg Timer of 12 hours is now engaged. So if the circuit was turned on at 6:00 PM that circuit will turn off at 6:00 AM (12 hours later). If the circuit was turned ON at 5:00 PM and because a programmed OFF time had been set to turn off at 4:00 PM, the circuit would operate for 11 hours. A spa or pool program can be overridden using the Spa button (Up arrow) or switch the Circuit On/Off pool filter pump on in the Circuit On/Off menu (see page 13).

### Edit an existing program

1. Press the Menu button until **Schedules 4/14** is displayed then press the **Right button**.
2. Press the **Up/Down button** to scroll through the circuits with their assigned programs.
3. Press the **Right button** to move to the first digit of the program number for the circuit. For example (2/4), two is the second program of four assigned programs.
4. Press the **Up/Down button** to select the desired program number.
5. Press the **Right button** to move to the mode setting.
6. Press the **Up/Down button** until Edit is displayed. To edit the start and stop time for the circuit, press the **Right button** to move to the Start setting.

### Delete a program

1. Press the Menu button until **Schedules 4/14** is displayed then press the **Right button**.
2. Press the **Up/Down button** to scroll through the circuits with their assigned programs.
3. Press the **Right button** to move to the first digit of the program number for the circuit. For example (3/4), one is the third program of four assigned programs.
4. Press the **Up/Down button** to select the desired program number.
5. Press the **Right button** to move to the mode setting. Press the **Up/Down button** until “Del” is displayed.
6. Press the **Right button** to delete the program 1. The program counter now displays (3/4). If you want to delete the other three programs, repeat steps 3 through 6.

## Clock Menu (5/14)

Use the Clock menu to set the SunTouch® Control System time. The current time in hours, minutes and AM/PM is displayed on the main screen. The system clock settings are used for the SunTouch Control System scheduled operations. The SunTouch Control System clock will continue to run even if power is removed from the SunTouch Control System at the enclosure.

### CLOCK

---

To set the system time:

Main Menu 5/14  
Clock

**Menu button:** Select the Clock menu.

**Right button:** Select the clock settings.

**Up/Down button:** Adjust the hour to the current time in your location including AM/PM).

Time Set 11:30 AM

**Right button:** Move to the minutes setting.

**Up/Down button:** Adjust the minutes to the current time.

**Left button:** Press the Left button to return to the main status screen.

## Solar Menu (6/14)

From the solar menu settings, you can enable/disable solar or a heat pump as the primary heat source.

**Notes about solar heating:** Install the solar sensor at the collectors. If “Heat Pump” is selected and is being used in place of a solar heating system, install the solar sensor near the SunTouch power center. Connect the solar sensor wires to the SOLAR screw terminals according to the wiring diagram on page 51. Plug the solar valve actuator cable into three-pin socket marked **VLV C** on the SunTouch Control System motherboard. If a solar booster pump is being installed, connect the pump to a power relay and plug a low voltage cable from relay into the two-pin socket marked SOLAR on the SunTouch Control System motherboard.

To access the Solar menu:

### SOLAR

---

To enable a solar as the heat source and set the temperature start and run time settings:

Main Menu 6/14  
Solar

**Menu button:** Select the Solar 6/14 menu.

**Right button:** Select the **Solar Status Enabled: No** setting.

**Up/Down button:** Select **Yes** to enable solar. If Yes is selected, Solar will be displayed in the main screen. Select **No** to disable solar heating.

Solar Status Enabled: Yes

If solar is enabled, the solar pump relay will switch on when the water temperature is lower than the set temperature setting, and the solar sensor temperature is higher than the water temperature. It might be necessary to adjust the pool and spa set temperature settings separately. The correct temperature setting will be used, which also depends on what position the pool and spa suction valve is currently in.

*Continue on next page...*

## Solar Menu (6/14) (Continued)

**Solar Freeze protection:** Use this feature to enable freeze protection for the solar equipment.

**Solar Freeze  
Enabled: Yes**

**Menu button:** The Solar Status setting is displayed.

**Right button:** Press the button until the Solar Freeze setting is displayed.

**Up/Down button:** Select **Yes** to enable solar freeze protection or **No** to disable freeze protection. If **Yes** is selected, the circuit will switch on if the air temperature drops to 36° F (2° C). This feature is used to protect the system plumbing from being damaged during freezing conditions. **Note:** *When freezing conditions are detected by the air sensor, the filter pump will be switched on and water will circulate continuously through the system.*

**Left button:** Press the Left button to return to the main status screen.

**Heat Start Temp  
Temp Diff: 6**

**Right button:** Select the **Heat Start Temperature Differential** setting.

**Up/Down button:** Adjust the temperature differential to start heating from 3° to 9°. For example, if “Heat Start Temp” is set to 3°, this ensures that the temperature has to deviate by 3° at least to the specified set point temperature (in the Heat menu, on page 18) before it switches on. Once the solar system is on it will start converging as it is heating. This ensures that it will not continually be switching on and off.

**Heat Stop Temp  
Temp Diff: 3**

**Right button:** Select the **Heat Stop Temperature Deferential** setting.

**Up/Down button:** Set the temperature differential to stop heating from 2° to 5°. This setting sets how close to the target set point temperature to switch off solar heat.

**Enable  
Heat Pump: Yes**

**Right button:** Select to the “Enable Heat Pump” setting.

**Up/Down button:** Select **Yes** to enable solar as a heat pump. Select **Yes** if a heat pump is being used in place of a solar heating system. If Solar is set to heat pump, **Valve C** is free to be used by other circuits (see page 26). Select **No** to disable heat pump.

**Cooling  
Enabled: Yes**

**Right button:** Select the **Cooling Enable** setting. See “Nocturnal Cooling” below for more information.

**Up/Down button:** Select **Yes** to enable heat pump cooling (used for nocturnal cooling). Select **No** to disable nocturnal cooling.

**Cool Start Temp  
Temp Diff: 6**

**Right button:** Select the **Cool Start Temperature Differential** setting.

**Up/Down button:** Adjust the cooling temperature differential to start cooling from 3° to 9°. For example, if Cool Start Temp is set to 3°, this ensures that the temperature has to deviate by 3° at least to the specified set point temperature (in the Heat menu, on page 18) before it switches on.

**Cool Stop Temp  
Temp Diff: 3**

**Right button:** Select the **Cool Stop Temperature Deferential** setting.

**Up/Down button:** Set the cool temperature differential to stop from 2° to 5°. This setting sets how close to the target cooling set point temperature to switch off.

**Left button:** Press the Left button to return to the main status screen.

**NOCTURNAL COOLING:** The transfer of solar heat to water occurs during the day when the BTU’s (heat) is harvested from the solar collector, then hot water is transferred into the swimming pool. When the pool water goes through the collector at night, in some climates as long as the night time air is cooler than the swimming pool water, the water will cool off. This transfer of heat to the night air to cool the water is referred to a “nocturnal cooling” or occurring during the night hours. This process is opposite to what occurs during the day time hours to generate heat from the sun. The solar collector is similar to a car radiator, in that cool air on the surface of the solar collector is used to cool the water off.

# Valves Menu (7/14)

The valves feature allows you assign a circuit to the extra valve output (Valve C) on the SunTouch® Control System motherboard. The SunTouch Control System can drive the auxiliary valve actuator for applications such as solar heating and water features and for freeze protection. By assigning any one of the auxiliary (AUX 1, AUX 2, AUX 3, FEATURE 1 - 4) circuits to control the valve actuator, you can conserve auxiliary circuits for high voltage relays for controlling pumps and lights.

*Note: When solar heating is enabled in the “Solar” menu (see page 20) and is not configured as a heat pump, Valve C is dedicated for controlling the solar heating valve actuator. Also, only “USED SOLAR” is displayed when solar is enabled. To select other circuits (AUX 1, AUX 2, FEATURE 1 - 4, etc.) solar must be switched off.*

## VALVE CIRCUIT

---

To assign a circuit to Valve C:

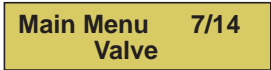

**Menu button:** Select the **Valve 7/14** menu.

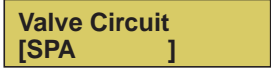

**Right button:** Select the Valves Circuit setting.

**Up/Down buttons:** Select a circuit to assign to Valve C. The circuits names are: NONE, SPA, POOL, AUX 1, AUX 2, AUX 3, FEATURES 1 - 4, SOLAR, HEATER and FREEZE (circuit protection).

*Note: “USED SOLAR” displays when solar is enabled in the “solar” menu, therefore no other circuits are available. For more information, see page 20.*

*Note: Freeze protection function protects the pool, plumbing, and equipment against freeze damage. If the outside air temperature sensor falls below 36° F, freeze protection is activated and the pool/spa filter pump relay is switched on to circulate the pool water.*

**Left button:** Press the Left button to return to the main status screen.

## Advanced Menu (8/14): Pool/Spa Delays

The pool and spa delays feature allows you to assign a delay function to the following equipment.

- **Heater Cool-Down Delay Cancel:** Shuts Filter Pump off immediately. Some heaters require a cool-down cycle before being switched off. This can be setup to run the filter pump an additional ten minutes to dissipate residual heat built up inside the heater combustion chamber. You can also cancel the delay feature. For information about using the cancel delay feature, refer to “Delay Cancel” on page 16.
- **Valve Delay:** If the heater is operating, and the VALVE DELAY feature is enabled for valves, this allows the heater to cool down (heater cool-down), then when the pump is switched off, only the heater will turn off, then the filter pump will automatically switch off after 10 minutes to allow the heater to cool down. Pentair Aquatic System heaters do not require a cool down time. To override the “heater cool-down,” press the filter pump button again to switch off the pump.
- **2-Speed Filter Pump five (5) minute START on HIGH SPEED Delay Cancel:** Shifts pump to low speed.
- **Automatic Pool Cleaner START Delay:** Starts Cleaner Pump immediately, without normal delay in which the filter pump first runs for five (5) minutes.
- **Automatic Pool Cleaner SOLAR Delay:** Allows Cleaner Pump to run even though the solar delay has shut it off for five (5) minutes.

### HEATER and VALVE DELAYS

---

To assign the heater delay feature:

Main Menu 8/14  
Advanced

**Menu button:** Select the **Advanced 8/14** menu.

**Right button:** Select the HEATER DELAY setting.

Heater Delay  
Enabled: Yes

**Up/Down buttons:** Select **Yes** to enable or **No** to disable delays for the pool and spa heater circuits.

**Left button:** Press the Left button to return to the main status screen.

To assign the valve delay feature:

Main Menu 8/14  
Advanced

**Menu button:** Select the **Advanced 8/14** menu.

**Right button:** Select the VALVE DELAY setting.

Heater Delay  
Enabled: Yes

**Up/Down buttons:** Select **Yes** to enable or **No** to disable delays for the pool and spa heater circuits.

**Left button:** Press the Left button to return to the main status screen.

## Advanced Menu (8/14): Temp Units F° / C° (Fahrenheit/Celsius)

The temperature settings for the water, solar and air can be displayed in either Fahrenheit or Celsius on the Main screen.

### FAHRENHEIT/CELSIUS

---

To change the temperature units:

Main Menu 8/14  
Advanced

**Menu button:** Select the **Advanced 8/14** menu.

**Right button:** Select the **TEMP UNITS (Fahrenheit/Celsius)** setting.

Temp Units  
[FAHRENHEIT ]

**Up/Down buttons:** Select either Fahrenheit or Celsius units for temperature settings displayed on the Main screen.

**Left button:** Press the Left button to return to the main status screen.

## Advanced Menu (8/14): Calibrate Water, Air and Solar Sensors

The SunTouch® Control System includes two temperature sensors for monitoring water and ambient air temperature. An additional air sensor for controlling solar heating systems can also be installed for solar systems. Generally, these sensors are accurate and do not require calibration. However, long plumbing runs and water features can cause temperatures at a body of water to be different from the temperature sensor reading. You can manually recalibrate the sensors to adjust for this. You only need to calibrate one body of water, since the temperature sensor is common to both the pool and spa.

### CALIBRATION

---

Before you start, you'll need an accurate all weather thermometer. When calibrating the air sensor, wait until the sensor is not in direct sunlight. For the air temperature sensor, make sure that the sensor is located in the shade for accurate readings.

To calibrate the water temperature sensor:

**Menu button:** Select the **Advanced 8/14** menu.

Main Menu 8/14  
Advanced

**Right button:** Press the button until **Calibrate Water** is displayed.

Calibrate Water  
Temp: 72 F

**Up/Down buttons:** To adjust the temperature use these buttons to raise or lower the water temperature to match the corresponding thermometer temperature reading.

When calibrating the water sensor, first switch off the heater. Check that the "Pool" filter pump circuit is set to "ON" to switch on the pool filter pump or press the Spa button (**Up button**) to circulate the water. Place the thermometer in the spa or pool water. Take an accurate temperature reading.

**Right button:** Select **Calibrate Air**.

Calibrate Air  
Temp: 77 F

**Up/Down buttons:** To adjust the temperature use these buttons to raise or lower the water temperature to match the corresponding thermometer temperature reading.

When calibrating the air sensor, place the thermometer next to the air sensor. The air sensor is normally located near or under the SunTouch Control System enclosure, not inside the enclosure. Take an accurate temperature reading in the shade.

**Right button:** Select **Calibrate Solar**.

Calibrate Solar  
Temp: 73 F

**Up/Down buttons:** To adjust the solar temperature use these buttons to raise or lower the water temperature to match the corresponding thermometer temperature reading.

Be sure that the solar sensor is in the sun for accurate readings.

**Left button:** Press the Left button to return to the main status screen.

## Advanced Menu (8/14): Air Sensor

If an optional ambient air temperature sensor is installed, the sensor must be enabled to display the current air temperature on the main status screen. The optional air temperature sensor is used to protect the system plumbing and equipment against freeze damage. For information about freeze protection for circuits, valves and auxiliaries, see page 26. The air sensor can be ordered separately (see page 38 for details).

To enable or disable the air sensor:

Main Menu 8/14  
Advanced

**Menu button:** Select the **Advanced 8/14** menu.

**Right button:** Select the **AIR SENSOR ENABLED: NO** setting.

Air Sensor  
Enabled: Yes

**Up/Down buttons:** Select **Yes** to enable the sensor. Select **No** to disable the sensor and not to display the air temperature in the main status screen.

**Left button:** Press the Left button to return to the main status screen.

*Note: If after enabling the air sensor the main screen displays **AIR Error** or **Solar Sensor ERR**, this indicates the solar sensor is not connected or it is out of range. See “Solar Sensor Error Message” for more information on page 66.*

## Advanced Menu (8/14): System Mode

From the System Mode menu you can configure the SunTouch® Control System to operate as a Solar Only mode system or as a Pool/Spa mode system (shared equipment). For more information about the “Solar Only” mode menu, see page 4. For more information about Pool/Spa mode, see page 9.

Main Menu 8/14  
Advanced

**Menu button:** Select the **Advanced 8/14** menu.

**Right button:** Select the **SYSTEM MODE** setting.

System Mode  
Pool/Spa

**Up/Down button:** Select **SOLAR ONLY** mode to configure SunTouch Control System as a solar system. Select **POOL/SPA** mode to configure SunTouch Control System as a stand-alone pool and spa automatic controller which include solar capabilities.

**Left button:** Press the Left button to return to the main status screen.

## Advanced Menu (8/14): System Type

From the System Type menu you can configure the SunTouch Control System for a pool and spa system (shared equipment), or as a Single Body of water system (pool only or spa only). For the “Single Body” system menu structure, see page 36.

Main Menu 8/14  
Advanced

**Menu button:** Select the **Advanced 8/14** menu.

**Right button:** Select the **SYSTEM TYPE** setting.

System Type  
Shared Equipment

**Up/Down button:** Select **Shared Equipment** to configure SunTouch Control System for a pool and spa system. Select **Single Body** to configure SunTouch Control System as a single body of water system.

**Left button:** Press the Left button to return to the main status screen.

## Advanced Menu (8/14): Circuit Timeout

From the Circuit Timeout menu you can set the system circuit timeout duration from one (1) to 23 hours. The default setting is 12 hours. If a circuit relay is switched on manually, it remains on until either it's switch it off manually or the default 12 hours has elapsed. This feature is useful to change the system circuit timeout duration of default 12 hours.

Main Menu 8/14  
Advanced

**Menu button:** Select the **Advanced 8/14** menu.

**Right button:** Select the **Circuit Timeout** setting.

Circuit Timeout  
12 Hours

**Up/Down button:** Select the timeout duration from one (1) to 23 hours.

**Left button:** Press the Left button to return to the main status screen.



## Advanced Menu (8/14): Reset Factory

SunTouch® Control System configuration data is stored and retained in “Flash” memory in an EEPROM located on the SunTouch Control System motherboard. The SunTouch Control System user system configuration data can be erased to restore the factory defaults settings. If the optional QuickTouch® QT4 Wireless Remote is installed it will need to be reconfigured.

### Reset to factory default settings

Main Menu 8/14  
Advanced

Reset Factory  
Erase All? Yes

Erase Memory?  
[YES ]

SunTouch  
7:30 AM

**Menu button:** Select the **Advanced 8/14** menu.

**Right button:** Press this button until RESET FACTORY ERASE ALL? setting is displayed.

**Up/Down button:** Select **Yes** to continue. Select **No** to exit the setting.

**Right button:** Press this button to continue. “Erase Memory” is displayed.

**Up/Down button:** Select **Yes** to continue. Select **No** to exit the setting.

**Right button:** Select **Yes** to erase system data and restore the factory default settings. The display will return to the main screen. **CAUTION:** *This procedure will erase all system settings.* Select **No** to exit the setting.

## Diagnostics Menu (9/14): Firmware Rev

Displays the current firmware revision for the SunTouch Control System.

Main Menu 9/14  
Diagnostics

Firmware Rev  
Rev: 2.0

**Menu button:** Select the **Diagnostics 9/14** menu.

**Right button:** View the SunTouch Control System firmware revision.

**Left button:** Press the Left button to return to the main status screen.

## Diagnostics Menu: Solar Temp

Displays the current solar temperature.

Main Menu 9/14  
Diagnostics

Solar Temp  
Temp: 77 F

**Menu button:** Select the **Diagnostics 9/14** menu.

**Right button:** Press the button until **SOLAR TEMP** displays. Use this feature for testing purposes and to verify the sensor temperature is connected and operating correctly.

**Left button:** Press the Left button to return to the main status screen.

## Diagnostics Menu: Self Test

To run a system self test:

Main Menu 9/14  
Diagnostics

Enter  
Self Test? Yes

Status: Passed  
Code: None

**Menu button:** Select the **Diagnostics 9/14** menu.

**Right button:** Press the button until Enter **SELF TEST** displays.

**Up/Down button:** Select **Yes** to continue. Select **No** to exit the Diagnostics menu.

**Right button:** Start the SunTouch Control System self test. The test includes testing the control panel, air and water sensors and valves. Follow the on-screen instructions.

After the test has been completed, the status screen will displays the results. A successful test will display - **Status: Passed - Code: None**. See page 66 for error codes.

**Left button:** Press the Left button twice to return to the main status screen.

## Diagnostics Menu: IntelliChem® Controller

To view the current IntelliChem® Controller pH and OPR status an RS-485 cable must be connected to the COM port on the SunTouch Control System (see page 56) and IntelliChem Controller circuit board.

IntelliChem  
pH: 7.50 ORP:735

**Menu button:** Select the **Diagnostics 9/14** menu.

**Right button:** Press the button until **IntelliChem control system** is displayed.

**Left button:** Press the Left button twice to return to the main status screen.

## Circuit Functions Menu (10/14)

### Assigning Circuit Functions

From the Circuit Functions menu you can assign special logic to the auxiliary relay circuits AUX 1 and AUX 2. For example, when setting up an automatic pool cleaner pump, you could assign AUX 1 the circuit function FLOOR CLEANER. With this “Cleaner” logic the cleaner pump would force the filter pump on, and the cleaner pump would start after a delay of five minutes. The cleaner pump would automatically shut off whenever the spa and/or solar is switched on.

**Using AUX 3 circuit:** The AUX 3 circuit connector on the SunTouch® Control System motherboard cannot be connected to a dedicated relay, however, it can be used as an extra assignment to control an electric heater or pump speeds. For example, AUX 3 can be assigned to control the high speed function of a 2-Speed pump, one of the four speeds of the IntelliFlo VS Pump or the flow rate (GPM) for the IntelliFlo® VF Pump. The pump speed control can be selected/activated via a scheduled program or switched on/off manually. Also, If VLV C is not enabled for solar, an additional pump could be connected to VLV C for a waterfall feature and AUX 3 could be assigned to control the valve actuator to divert water for the waterfall feature.

### Freeze Protection

Freeze protection switches on a circuit if the outside air temperature sensor detects the temperature is getting close to freezing (below 36° F). The system will switch on the circuits that have been assigned freeze protection, and runs the circuits for every 15 minutes to stop the pipes from freezing. For pool and spa combination the valves will rotate between the pool and spa. During this process the cleaner will be switched off. This is especially important if there is a pool and spa combination. If freeze protection is set to both the spa and pool circuits, the filter pump (and booster pump if installed) switches on and the pool and spa valves alternate every 15 minutes to keep the water moving in both the pool and spa. This process continues until the freeze condition is over.

### CIRCUIT FUNCTIONS

To assign a circuit function and freeze protection: *Note: The air sensor **must** be enabled for freeze protection (see page 24):*

Main Menu 10/14  
Circ. Functions

**Menu button:** Select the **Circ. Functions 10/14** menu.

Pool Circuit  
Freeze: OFF

**Right button:** Set **POOL CIRCUIT FREEZE** protection for the pool circuit.

**Up/Down buttons:** Select **Yes** to enable freeze protection for the pool or **No** to disable freeze protection.

Spa Circuit  
Freeze: OFF

**Right button:** Set **SPA CIRCUIT FREEZE** protection for the spa circuit.

**Up/Down buttons:** Select **Yes** to enable freeze protection for the spa or **No** to disable freeze protection.

AUX 1 Circuit  
[CLEANER ]

**Right button:** Choose the type of logic needed for the AUX 1 circuit.

**Up/Down buttons:** Set the type of circuit to use. The functions are: GENERIC, CLEANER, SPILLWAY, FLOOR CLEANER, HEATER, SOLAR. This is the circuit that you wish to assign the function logic to. For a description of the preset circuit types, see “Preset Circuit Functions,” on page 27. *Note: For in-floor cleaning systems with two main valves which need to alternate every 20 minutes. This feature allows a motorized three-way valve to rotate every 20 minutes during pool filtration cycle.*

AUX 1 Circuit  
Freeze: OFF

**Right button:** Set freeze protection for AUX 1 circuit.

AUX 2 Circuit  
Freeze: OFF

**Up/Down buttons:** Select **Yes** or **No**. If **Yes** is selected, the circuit will switch on if the air temperature drops to 36° F (2° C). *Note: for the POOL circuit the filter pump will have freeze protection. For the SPA circuit the filter pump will run and the pool/*

AUX 3 Circuit  
[HEATER ]

*spa valves will switch between pool and spa at 15 minutes intervals throughout the freeze condition. For the FLOOR CLEANER circuit freeze protection is generally not needed for pool cleaner pumps since they get water flow from the filter pump. Just make sure that POOL has freeze protection.*

AUX 3 Circuit  
Freeze: ON

Repeat as above to assign functions for AUX 2 and AUX 3.

**Left button:** Press the Left button to return to the main status screen.

## Circuit Functions Menu (10/14) (Continued)

### Preset Circuit Functions

---

**Generic** No special Logic. Simple On/Off control of a circuit with all the programmable capabilities.

---

**Solar** Works with automatic pool cleaner pumps or cleaner valve actuator. It does the following:

- Forces the filter pump on 5 minutes before the cleaner pump switches on.
  - Switch the cleaner off when the spa is on.
  - Switch the cleaner off for 5 minutes when the solar heating begins.
- 

**Floor Cleaner** This setting moves a 3-way valve every 20 minutes alternating flow between two cleaner system valves that feed the pop-up heads.

---

**Spillway** For pool/spa combinations where the spa is raised above the pool. This setting moves the return valve so that the filter pump pulls the water from the pool and returns it to the spa, creating a water fall effect. Automatic pool cleaners are turned off when this feature is turned on.

---

## Settings Menu (11/14): QuickTouch® (QT4) Wireless Remote

The QuickTouch® (QT4) Wireless Remote provides switching of up to four circuits. For example, you can use the QT4 Wireless Remote to activate the spa circulation, and for operating three auxiliary pieces of equipment (such as heat enabled, lights, jet pump, heat boost, air blower, waterfall, etc.).

Each of the four functions on the QT4 Wireless Remote has an on and an off button. To switch a circuit on or off, press and hold the appropriate button for at least a full second.

The QT4 Wireless Remote4 buttons can be assigned to any available circuit. However, the QT4 has the following preset circuits assigned to the four buttons:

- The SPA button activates the spa circuit (same as the Up button on the SunTouch Control System Control Panel.)
- A button activates the AUX 1 circuit.
- B button activates the AUX 2 circuit.
- C button activates the AUX 3 circuit (see page 26 for AUX 3 assignment information).

### Assign QuickTouch (QT4) buttons

---

To assign circuits to the QuickTouch Wireless Remote buttons:

Main Menu 11/14  
QuickTouch

**Menu button:** Select the **QuickTouch 11/14** menu.

QuickTouch  
SPA - [SPA ]

**Right button:** Assign the **QuickTouch SPA button** to a circuit.

**Up/Down buttons:** Choose a circuit to assign to the SPA button. The circuit selections are: None, Spa, Pool, AUX 1, AUX 2, AUX 3, FEATURE 1 - 4, HEAT BOOST, HEAT ENABLED. Selecting “None” does not assign a circuit.

QuickTouch  
1 - [HEAT BOOST]

*Note: The “Heat Boost” feature will switch on the heater for seven minutes to increase the spa water temperature. Each time the spa Heat Boost button is pressed, the temperature will increase about 1° F. The temperature will not go beyond the 104° F (40° C) limit.*

QuickTouch  
2 - [POOL ]

QuickTouch  
3 - [AUX1 ]

**Right button:** Assign button A to a circuit 1. Use the Up/Down buttons to select a circuit for button A. Repeat the process for Buttons B (AUX 2 circuit 2) and C (AUX circuit 3).

**Left button:** Press the Left button to return to the main status screen.

## Pump Menu (12/14)

From the Pump menu you can setup SunTouch® Control System to operate a single-speed or two speed pump, or assign up to eight speeds and circuits for the IntelliFlo® VS and VF Pumps. The SunTouch® control system can be setup to operate either one IntelliFlo VS or one IntelliFlo VF pump. The SunTouch® Control System communicates with the IntelliFlo VS and the IntelliFlo VF pump via a two-wire RS-485 cable. For information about connecting the RS-485 communication cable from SunTouch control system Power Center to the IntelliFlo pump, refer to the IntelliFlo VS Pump Installation and User’s Guide (P/N 357269).

### SINGLE SPEED FILTER PUMP

---

For a single-speed pump there are no assigned pump circuits. The pool filter pump schedule program determines when the pump is switched on and off. If the heat source is enabled in the “Heat” menu (see page 14), when the pool or spa circuit is activated the selected heat source is also enabled. The default time before the filter pump will switch off is 12 hours. If the pool/spa circuit is switched off and the heater is operating, only the heater will turn off, then the filter pump will automatically switch off after 10 minutes to allow the heater to cool down. Pentair Aquatic Systems heaters do not require a cool down time. To override the “heater cool-down,” press the Filter Pump button again to switch off the pump.

To select a single-speed pump.

Main Menu 12/14  
Pumps

**Menu button > Right button:** Select the **Pumps 9/14** menu.

**Right button:** Press the button to select the pump settings.

**Up/Down buttons:** Select Single Speed. A single-speed pump has no assigned circuit. The pool filter schedule determines when the pump is switched on and off. For more information, see Schedules Menu on page 17.

**Right button:** Press this button to exit to the main menu items.

**Left button:** Press the Left button to return to the main status screen.

Pump Type  
[SINGLE SPEED]

## TWO SPEED FILTER PUMP

**Note: There must be a two-speed relay installed in the SunTouch® Control System enclosure and plugged into the AUX3 connector for the “Two-Speed” pump menu feature to operate.**

The Two Speed or High Speed can have a number of circuits or features associated with it. A maximum number of four (4) items is allowed. The list includes Spa, Pool, AUX1, AUX2, AUX3, Feature 1–4, Solar, Heater, Pool Heat, Spa Heat, Freeze, Pool/Spa, Solar/H (Solar/Heater).

Any Circuit or Item listed in one of the four (4) slots will force the pump to High Speed when that item is on or active.

Assigned circuits will automatically switch a two-speed filter pump from low to high speed when these circuits are switched on setup in the Schedules menu. If a two-speed pump is assigned to solar, as a cleaner or filter pump, when the circuit is activated the pump will automatically run for five minutes in high speed then switch to low speed.

Main Menu 12/14  
Pumps

**Menu button > Right arrow button:** Select the **Pumps 12/14** menu.

**Right button:** Press this button to select the **Pump Type**.

Pump Type  
[TWO SPEED ]

**Up/Down buttons:** Select **TWO SPEED**.

High Pump Circuits  
1 - [POOL ]

**Right button:** Select **High Pump Circuits**. You can assign up to four (4) High Speed Circuits/Functions.

High Pump Circuits  
2 - [SPA ]

**Up/Down buttons:** Select circuit you want to activate **High Speed**. The selection are listed above. If a slot is unused, or you wish to make it unused select NONE.

High Pump Circuits  
3 - [NONE ]

High Pump Circuits  
4 - [FREEZE ]

**Right button:** Select the second circuit to activate **High Speed**.

**Right button:** To move to the third or fourth slot. When at the fourth slot the **Right Button** will return you to the menu at **PUMPS 12/14**.

AUX 3 Circuit  
[POOL ON ]

**Left button:** Press this button to return to the main status screen.

AUX 3 Circuit  
[SPA ON ]

*Note: ‘Pool/Spa’ is when either Pool or Spa is on, ‘Solar/HT’ is when Solar or Heater is active. These are useful if you want High Speed in either case, and it saves one of the four slots as you don’t need to enter them as separate items.*

AUX 3 Circuit  
[NONE ]

AUX 3 Circuit  
[FREEZE ON ]

*Note: The AUX3 output is dedicated for the use of a Two Speed relay. The AUX 3 in schedules, or in one of the four (4) slots here for example it acts as an extra Feature Circuit.*

Main Menu 12/14  
Pumps

*Note: If any circuit or item is listed in one of the four (4) slots the system will automatically force High Speed for five (5) minutes anytime Solar, Heater, or Cleaner first start up. If any of those items is listed in the High Speed list, it will of course remain at High Speed as long as it is on or active.*

## Pump Menu (12/14) (Continued)

### IntelliFlo® VS Pump

#### Connecting power to an IntelliFlo® Pump

The IntelliFlo® Pump is designed to be permanently connected to its power source. Typically the pump receives power directly from the circuit breaker. No contactor or motor starter is required. The drive controls the starting and stopping of the pump. If the IntelliFlo Pump is connected to an automation system, such as the SunTouch® Control System, the drive must be powered up to receive and respond to the RS-485 serial communication from the automation system. However, the pump can be operated in “stand-alone” mode, starting and stopping when power is applied or removed. When the drive powers up it will return to the mode and run status that it was in when power was removed. This setup maybe appropriate if you need to use existing relays or timers.

#### Assigning an IntelliFlo® VS 3050 Pump address

Before assigning a pump address in the IntelliTouch® Control System indoor control panel, first set the address **on the pump itself**. If there is only one pump, it is always seen as pump #1 by the IntelliTouch® Control System. In this case you do not need to set the pump address. When using multiple IntelliFlo VS 3050 pumps with IntelliTouch Control System you need to assign an address to each pump. The address can be set to #1, #2, #3, or #4. The address set at the pump must match the IntelliFlo Pump number selected in the IntelliTouch® Control System Indoor Control Panel.



IntelliFlo® VS 3050 Pump Speed buttons

To assign an IntelliFlo VS 3050 pump address:

1. Be sure that the pump is powered on and the green power LED is on.
2. Press the **Stop** buttons to stop the pump.
3. Press and hold both the **Start and Stop** buttons until the red LED will starts flashing, then press one of the four speed buttons (1-4) to select which address to assign the pump. For example, if you are assigning the pump as pump #1, then press Speed button number 1.
4. Press and hold both the **Start and Stop** buttons to save the address. Repeat the process for the other pumps.

**NOTE: INTELLIFLO PUMP IN “SERVICE MODE”** - IntelliFlo pumps will STOP when IntelliTouch Control System is in “Service” mode.

**NOTE: INTELLIFLO PUMP “FREEZE” PROTECTION** - If the IntelliFlo Pump is on due to a freeze condition (not switch on from a relay circuit), and if a freeze speed is set in SunTouch Control System, this setting takes priority even if the previous setting is lower than the default circuit speed. If no “freeze” protection is set, the pump will be forced on at the default circuit speed. Any programmed or manual operation that actually switches on a circuit, will cause the pump to run at that speed if it is higher.

#### Freeze Protection

Freeze protection protects the pool, plumbing, and equipment against freeze damage. If the outside air temperature sensor falls below 36° F (2° C), freeze protection is activated and the pool/spa filter pump relay is switched on to circulate the pool water. To enable freeze protection for a circuit, see page 26. In order to use the SunTouch Control System freeze protection function, an optional sensor is required to monitor the air temperature. To enable freeze protection and display the outside air temperature on the main screen, the “AIR SENSOR” must be enabled (see Advanced Menu 8/14 on page 24). Freeze protection is enabled whenever the outside temperature is 36° F or lower. When freezing conditions are detected by the air sensor, SunTouch will switch the filter pump on and circulate pool water continuously through the pool and spa. For SunTouch Control System “solar only” systems, the optional air sensor and an additional time clock connected to the filter pump is required for freeze protection. **Note:** If multiple AUX circuits are set to ON, when freeze is active, the circuit will run the pump at the highest assigned speed of the active circuit.

# Pump Menu (12/14) (Continued)

## IntelliFlo® VS pump (Continued)

From the IntelliFlo VS Pump menu you can assign an auxiliary circuits to control four different pump speeds. The pump speed can be adjusted from 400 to 3450 RPM in increments of 10 RPM. For more information about the IntelliFlo VS Pump, refer to the IntelliFlo VS Pump Installation and User’s Guide (P/N 357269). To assign up eight (8) pump speeds and circuits for the IntelliFlo VS3050 Pump:

Main Menu 12/14 Pumps
Pump Type [INTELLIFLO VS ]
Pumps Parameters Menu: SPEEDS
Assign Speeds 1 - RPM: 3450
Circuit Setup 1 - [ SPA ]

**Menu button:** Select the **Pumps 12/14** menu.  
**Right button:** Press the button to view the type of pump to select.  
**Up/Down buttons:** Select **IntelliFlo VS**. Press **Right button** again to select.  
 Press **Up/Down buttons** to view the pump parameters menus: **SPEEDS, PRIMING or STATUS**. Press **Right button** to select. Press the **Right button** again to **ASSIGN SPEEDS** (RPM) setting. Press **Up/Down buttons** set the pump speed. Pump speeds can be set from 400 to 3450 RPM in increments of 10 RPM. The default speed for each circuit is the same as the four speed buttons on the IntelliFlo VS Pump control panel. The preset speed which corresponds to each of the four buttons on the pump are: 1 button 750 RPM, 2 button 1500 RPM, 3 button 2350 RPM, and 4 button 3110 RPM.

Pumps Parameters Menu: PRIMING
Priming Params Time: 5
Priming Params Speed: 1000

Press **Right button** to **ASSIGN CIRCUIT** for the pump. Press **Up/Down buttons** to view the circuits for the first of eight pump circuits: [NONE, SPA, POOL, AUX 1, AUX 2, AUX 3, FEATURE 1 - 4, SOLAR, HEATER, FREEZE, POOL/SPA, and SOLAR/HT (solar/heater)]. Press **Right button** to select the circuit. *Note: Selecting “Pool/Spa” or “Solar/HT” combines several circuits into the same pump speed for pool and spa or for solar and heater combination systems. Normally this would require programming two separate pump speeds for each function. Using one of these selections, free-up one of the four pump speed for other uses.*

Pumps Parameters Menu: STATUS
RPM: 1500 75 W
Status: NORMAL

**Right button:** Press this button to continue to assign pump **SPEEDS** and **CIRCUITS**. You can assign up to eight (8) pump speeds and circuits. When finished assigning speeds and circuits, press the **Right button** until **SPEEDS** is displayed, then press the **Up/Down buttons** and select **PRIMING**. Press **Right button** to select **Priming Params Time**. Press the **Up/Down buttons** to set the priming time (0 to 10 minutes). When finished, Press **Right button** to select **Priming Params Speed**. Press the **Up/Down buttons** to set the priming speed (4000 - 3450 RPM). **To select STATUS**, press the **Right button** three (3) time, then press the **Up/Down button** to select **STATUS**. Press the **Right button** to view the current RPMs and operating Watts. Press the button again to view the current pump communication status.  
**Left button:** Press the Left button to return to the main status screen.

## Pump Menu (12/14) (Continued)

### IntelliFlo® VF Pump

From the IntelliFlo® VF Pump menu you can assign circuits to control the pump flow rate (GPM), priming, also filter, backwashing, vacuum functions and view the current pump status. For more information about the IntelliFlo VS Pump, refer to the IntelliFlo VF Pump Installation and User's Guide (P/N 350075).

To assign up eight (8) pump speeds and circuits for the IntelliFlo VS Pump:

Main Menu 12/14 Pumps	<b>Menu button:</b> Select the <b>Pumps 12/14</b> menu.
Pump Type [INTELLIFLO VF ]	<b>Right button:</b> Press the button to view the type of pump to select. <b>Up/Down buttons:</b> Select <b>IntelliFlo VF</b> then press <b>Right button</b> again to select. Press <b>Up/Down buttons</b> to view the <b>Pump Parameters</b> menus: <b>CIRC. SETUP</b> , <b>FILT. CIRC.</b> , <b>FILTER</b> , <b>PRIMING</b> , <b>BACKWASH</b> , <b>VACUUM</b> and <b>STATUS</b> . Press <b>Right button</b> to choose one of the parameters.
Pumps Parameters Menu: CIRC. SETUP	Press the <b>Right button</b> again to <b>ASSIGN FLOWS</b> (GPM) setting.
Assign Flows 1 - GPM: 80	Press <b>Up/Down buttons</b> set the pump flow rate (15 - 130 GPM).
Circuit Setup 1 - [ POOL ]	Press <b>Right button</b> to <b>CIRCUIT SETUP</b> for the pump. Press <b>Up/Down buttons</b> to view the circuits for the first of eight (8) pump circuits: [NONE, SPA, POOL, AUX 1, AUX 2, AUX 3, FEATURE 1-4, SOLAR, HEATER, POOL HEAT, SPA HEAT, FREEZE, POOL/SPA, and SOLAR/HT (solar/heater)].

Press **Right button** to select the circuit. *Note: Selecting "Pool/Spa" or "Solar/HT" combines several circuits into the same pump speed for pool and spa or for solar and heater combination systems. Normally this would require programming two separate pump speeds for each function. Using one of these selections, free-up one of the four pump speed for other uses.*

Press **Right button** to continue to assign pump **FILT. CIRC.** and **CIRCUITS**. You can assign up to eight (8) pump speeds and circuits.

Pumps Parameters Menu: FILTER	When finished assigning pump flow rate and circuits, press the <b>Right button</b> until <b>FLOWS</b> is displayed, then press the <b>Up/Down buttons</b> and select <b>FILTER</b> .
Filter Params Size: 25000	Press <b>Right button</b> to select <b>Filter Params Time</b> . Press the <b>Up/Down buttons</b> to set the Filter Size (1000 to 255000 gallons).
Filter Params Turns: 2	Press <b>Right button</b> to select <b>Filter Params Manual Filter</b> . Press the <b>Up/Down buttons</b> to set the Filter Size (15 - 130).
Filter Params Man Filt: 30	

When finished, Press **Right button** to select **Filter Params Turns**. Press the **Up/Down buttons** to set the number of pool cycle turns (1-4).

When finished assigning filter parameters, press the **Right button** until **FLOWS** is displayed, then press the **Up/Down buttons** and select **FILTER**.

Press **Right button** to select **Filter Params Time**. Press the **Up/Down buttons** to set the Filter Size (1000 to 255000 gallons).

Press **Right button** to select **Filter Params Manual Filter**. Press the **Up/Down buttons** to set the Filter Size (15 - 130).



## Pump Menu (12/14) (Continued)

### IntelliFlo® VF Pump (Continued)

#### Assigning an IntelliFlo VF 3050 Pump Address

Before assigning a pump address in the SunTouch® Control System for IntelliFlo® VF Pump, first set the address **on the pump itself**.

If there is only one pump, it is always seen as pump #1 by SunTouch Control System. In this case you do not need to set the pump address. When using multiple IntelliFlo Pumps with SunTouch Control System assign an address to each pump. The address can be set to #1, #2. The address set at the pump must match the IntelliFlo Pump number selected in the **PUMPS > PUMP TYPE >** menus.

**Note:** *IntelliFlo VF 3050 Pumps cannot be connected in series with other pumps. Check valves must be used when a pump is used in parallel with other pumps.*

To assign an IntelliFlo VF 3050 Pump address:

1. Press the **Start/Stop** button to stop the pump. Be sure that the green power LED is on and the pump is stopped.
2. Press the **Menu** button.
3. Press the **Up and Down** arrow buttons to scroll through the menu items. Press the **Select** button to access the “Pool Data” menu.
4. Press the **Select** button to access the “Pump Address” setting.
5. Press the **Select** button to change the current pump address.
6. To enter the new address number, press the **Left** and **Right** arrows to select which digit to modify, then use the **Up** and **Down** arrows to change the selected digit.

**NOTE: INTELLIFLO “FREEZE” PROTECTION** - *If the IntelliFlo Pump is on due to a freeze condition (not switch on from a relay circuit state), and if a freeze speed/flow is set in IntelliTouch® Control System, this setting takes priority even if the previous setting is lower than the default circuit speed. If no “freeze” protection is set, the pump will be forced **on** at the default circuit speed/flow. Any programmed or manual operation that actually switches on a circuit, will cause the pump to run at that speed if it is higher.*

**NOTE: INTELLIFLO PUMP IN “SERVICE MODE”** - *The IntelliFlo Pump will STOP when SunTouch Control System is in ‘Service’ mode.*

**NOTE: INTELLIFLO VF PUMPS** - *If the IntelliFlo VF Pump is just starting (requiring a prime) and SOLAR is available, solar will be delayed for five (5) minutes to allow the pump to prime. This only applies for IntelliFlo pump(s) assigned as to a “pool” pump.*

## Pump Menu (12/14) (Continued)

### IntelliFlo® VF Pump

Pumps Parameters  
Menu: PRIMING

Priming Params  
Max Flow: 55

Priming Params  
Max Time: 5

Priming Params  
Sys Time: 1

When finished, Press **Right button** three times until FILTER is displayed.

Press the **Up/Down buttons** to select **PRIMING**.

Press the **Right button** to select **Priming Params: Max Flow**.

Press the **Up/Down buttons** to select the maximum flow GPM rate (15-130).

Press the **Right button** to select the **Max Time**, press the **Up/Down buttons** to select the maximum time from 1 to 15 minutes.

Press the **Right button** to select the **Sys Time**, press the **Up/Down buttons** to select the maximum time from 1 to 15 minutes.

Pumps Parameters  
Menu: BACKWASH

Backwash Params  
Clean Filt: 10

Priming Params  
Flow GPM: 60

Priming Params  
Duration: 5

Priming Params  
Rinse Time: 5

When finished assigning filter parameters, press the **Right button** until **PRIMING** is displayed, then press the **Up/Down buttons** to select **BACKWASH**.

Press **Right button** to select **Backwash Params Clean Filt**:

Press the **Up/Down buttons** to set the filter clean time (1-50 minutes).

Press **Right button** to select **Flow GPM**. Press the **Up/Down buttons** to set the flow rate (15-130 GPM).

Press **Right button** to select **Duration**. Press the **Up/Down buttons** to set the duration (1-60 minutes).

Press **Right button** to select **Rinse Time**. Press the **Up/Down buttons** to set the rinse time (1-60 minutes).

Pumps Parameters  
Menu: VACUUM

Vacuum Params  
Flow (gpm): 65

Vacuum Params  
Time (min): 30

When finished assigning filter parameters, press the **Right button** until **BACKWASH** is displayed, then press the **Up/Down buttons** to select **VACUUM**.

Press **Right button** to select **Vacuum Params Flow (gpm)**: Press the **Up/Down buttons** to set the gpm flow rate (15-130 GPM).

Press **Right button** to select **Flow GPM**. Press the **Up/Down buttons** to set the flow rate (15-130 GPM).

Press **Right button** to select **Time (min)**. Press the **Up/Down buttons** to set the vacuum time (1-600 minutes).

Press **Right button** to select **Rinse Time**. Press the **Up/Down buttons** to set the rinse time (1-60 minutes).

Pumps Parameters  
Menu: STATUS

RPM: 1500    75 W  
GPM: 50

Filter: 0  
Status: NORMAL

When finished assigning vacuum parameters, press the **Right button** until **VACUUM** is displayed, then press the **Up/Down buttons** to select **STATUS**.

Press **Right button** to view the current RPM, WATTS and GPM status.

Press the **Right button** again to view the Filter and pump operation status.

Pumps Parameters  
Menu: FILT. CIRC

Filter Circuit  
[ POOL ]

When finished assigning vacuum parameters, press the **Right button** until **STATUS** is displayed, then press the **Up/Down buttons** to select **FILT. CIRC**.

Press **Right button** to view the filter circuits. Press the **Up/Down buttons** to select the circuit: (NONE, SPA, POOL, AUX 1, AUX 2, AUX 3).

**Left button:** Press the Left button to return to the main status screen.

## Pump Menu (12/14) (Continued)

### IntelliFlo® VSF+SVRS Pump

From the IntelliFlo® VSF+SVRS Pump menu you can assign circuits to control the pump flow rate (GPM/RMP), priming, also filter, backwashing, vacuum functions and view the current pump status. For more information about the IntelliFlo VS Pump, refer to the IntelliFlo VF Pump Installation and User's Guide (P/N 350075).

To assign up eight (8) pump speeds and circuits for the IntelliFlo VS pump:

Main Menu 12/14 Pumps	<b>Menu button:</b> Select the <b>Pumps 12/14</b> menu. <b>Right button:</b> Press the button to view the type of pump to select.
Pump Type [INTELLIFLO VF ]	<b>Up/Down buttons:</b> Select <b>IntelliFlo VF</b> then press <b>Right button</b> again to select. Press <b>Up/Down buttons</b> to view the <b>Pump Parameters</b> menus: <b>CIRC. SETUP</b> , and <b>STATUS</b> . Press <b>Right button</b> to choose one of the parameters.
Pumps Parameters Menu: CIRC. SETUP	<b>CIRCUIT SETUP:</b> Press <b>Right button</b> to assign a circuit to the pump. Press <b>Up/Down buttons</b> to view the circuits for the first of eight (8) pump circuits: [NONE, SPA, POOL, AUX 1, AUX 2, AUX 3, FEATURE 1-4, SOLAR, HEATER, POOL HEAT, SPA HEAT, FREEZE, POOL/SPA, and SOLAR/HT (solar/heater)].
Circuit Setup 1 - [ POOL ]	
Assign Circuit 1 - [SPA ]	<b>GPM/RPM Mode:</b> Press the <b>Right button</b> to set the GPM and RPM pump speed. Press <b>Up/Down button</b> to toggle between RPM and GPM/PSI.
GPM/RPM Mode GPM (RPM)	The Assign Flows screen displays. Press <b>Up/Down buttons</b> to set the pump flow rate from 15 - 130 GPM. The default flow rate is 30 GPM. The preset speed for each button is: <b>Speed 1 button 1100 RPM (30 GPM), Speed 2 button 1500 RPM, Speed 3 button 2350 RPM, and Speed 4 button 3110 RPM.</b>
Assign Flows 1 - GPM: 80	Press the <b>Right button</b> again to set the PSI setting. Press <b>Up/Down buttons</b> to set pump pressure setting from 1 to 30 PSI.
Assign PSI 1 - PSI: DSBL	Press <b>Right button</b> to select the circuit. <i>Note: Selecting "Pool/Spa" or "Solar/HT" combines several circuits into the same pump speed for pool and spa or for solar and heater combination systems. Normally this would require programming two separate pump speeds for each function. Using one of these selections, free-up one of the four pump speed for other uses.</i>
Assign Flows 1 - GPM: PSI	
Assign Speeds 1 - RPM: 7710	Press <b>Right button</b> to continue to assign pump <b>FILT. CIRC.</b> and <b>CIRCUITS</b> . You can assign up to eight (8) pump speeds and circuits.

When finished assigning pump flow rate and circuits, press the **Right button** until **FLOWS** is displayed, then press the **Up/Down buttons** and select **FILTER**.

Press **Right button** to select **Assign Flows**. Press the **Up/Down buttons** to set the flow rate from 15-150 GPM.

Press **Right button** to select **Assign PSI**. Press the **Up/Down buttons** to set the pressure rate from 1-30 PSI.

**Left button:** Press the Left button to return to the main status screen.

## IntelliChlor® Salt Chlorine Generator Menu (13/14)

The IntelliChlor® Salt Chlorine Generator (SCG) menu features allow you to view the current salt level (ppm) status, enable or disable the IntelliChlor (SCG) cell, control the amount of chlorine production and to super chlorinate your pool/spa. While in normal operating mode (Pool, Spa mode or Spa Fill (Spillway), the SunTouch® Control System will control the chlorinator output level. When the IntelliChlor (SCG) is connected to the SunTouch Control System COM port on the motherboard, chlorination levels can only be changed from the SunTouch Control System control panel. The IntelliChlor (SCG) control panel will be disabled. The amount of chlorine introduced into the pool is determined by the amount of salt in the water, the water temperature and the amount of time the pool operates in “Pool/Spa” mode. The IntelliChlor (SCG) menu features are active when the salt chlorine generator is connected to the COM port on the SunTouch Control System motherboard. **Note:** While in “Freeze Protection” mode, the IntelliChlor (SCG) will not operate during the time that the filter pump is operating. For more information, refer to the IntelliChlor Electronic Chlorine Generator User’s Guide (P/N 520589).

### IntelliChlor (SCG)

To setup the IntelliChlor (SCG):

Main Menu 13/14 IntelliChlor	<b>Menu button:</b> Select the “IntelliChlor” menu.
IntelliChlor Enable: YES	<b>Right button:</b> Enable or Disable IntelliChlor setting.
IntelliChlor Pool %: 50	<b>Up/Down buttons:</b> Select <b>Yes</b> to enable or <b>No</b> to disable IntelliChlor.
IntelliChlor Spa %: 0	<b>Right button:</b> Move to set the chlorine level for the pool.
IntelliChlor Spa %: 0	<b>Up/Down buttons:</b> Set the percentage amount of chlorine to produce in the pool. Set the chlorination output level for the pool/spa water from 0 to 100%. The SunTouch control system will determine the chlorinator output level when the system is operating in “Spa” or “Pool” mode. The amount of chlorine introduced into the pool/sap is determined by the amount of salt in the water, the water temperature and the amount of time the pool/spa operates in these modes mode. Use the Up button to increase the percentage level, and the Down button to decrease the percentage level.
IntelliChlor Spa %: 0	<b>Right button:</b> Move to set the chlorine level for the spa.
IntelliChlor Spa %: 0	<b>Up/Down buttons:</b> Set the percentage amount of chlorine to produce in the spa. Set the percent level from 0% to 100% (Super Chlorination). Use the Up button to increase the percentage level, and the Down button to decrease the percentage level.
IntelliChlor Spa %: 0	<b>Right button:</b> Move to the Super Chlorination settings (see below). If you do not want to Super Chlorinate the pool/spa, press the Right button to skip these settings until the salt level/status screen displays.
IntelliChlor Spa %: 0	<b>IntelliChlor status and error messages:</b>
Salt: 2900 ppm [OK - NO ERRORS]	<b>Up/Down buttons:</b> The current pool/spa salt level (ppm) is displayed on the screen. If an IntelliChlor (SCG) error is detected, an error message will be is displayed on the screen. To view the IntelliChlor (SCG) status and error messages, see “IntelliChlor Status and Error Messages” on page 32. Press the Right button to return to the main menu items.
IntelliChlor Super Chlor: YES	<b>Super Chlorination:</b>
IntelliChlor Run Hours: 12	<b>Up/Down buttons:</b> Select <b>Yes</b> to enable Super Chlorination or <b>No</b> to disable Super Chlorination.
IntelliChlor Run Hours: 12	<b>Right button:</b> Move to the Super Chlorination “Run Hours” setting.
IntelliChlor Run Hours: 12	<b>Up/Down buttons:</b> Set the number of hours to run Super Chlorination. 24 hours is the default setting. The run hours can be set from 0 to 72 hours. Use the Up button to increase the run hours, and the Down button to decrease the run hours.
Salt: 3200 ppm [SUPR CHLRINATE]	The display shows the current salt level in the water.
Salt: 3200 ppm [SUPR CHLRINATE]	<b>Left button:</b> Press the Left button to return to the main status screen.

## IntelliChlor® Salt Chlorine Generator Menu (13/14): Status and Error Messages

If an error alert, or warning is detected by the IntelliChlor® Salt Chlorine Generator (SCG), the error message will be displayed on the SunTouch Control System control panel screen. All status and error messages can be viewed from the IntelliChlor (SCG) menu. For troubleshooting information, refer to the IntelliChlor Electronic Chlorine Generator User's Guide (P/N 520589).

To view the IntelliChlor (SCG) status and error messages:

**Main Menu 13/14**  
**IntelliChlor**

**Salt: 3200 ppm**  
**[OK - NO ERRORS]**

**Menu button:** Select the "IntelliChlor" menu.

**Right button:** Press the button until the Salt status screen is displayed.

Displays the current IntelliChlor (SCG) chlorination system status.

**Left/Right button:** Press the Left or Right button to return to the main status screen.

**IntelliChlor status and error messages:**

**SALT LEVEL:** Displays the current salt level. Values from 0 to 12750 ppm in 50 ppm increments.

IntelliChlor Status and Error messages:

**SUPER CHLORINATE:** The IntelliChlor (SCG) is in Super Chlorination mode. For information

**COM LINK ERROR:** Check cable from the IntelliChlor (SCG) to the SunTouch Control System motherboard.

**Check FLOW/PCB:** Check the IntelliChlor (SCG) controller. Refer to IntelliChlor (SCG) User's Guide Troubleshooting information.

**LOW SALT:** Add salt to pool water. The water salt level is between 2500 ppm and 2950 ppm. The IntelliChlor (SCG) will continue to produce chlorine at a reduced level.

**VERY LOW SALT:** Not enough salt in pool. The water salt level has fallen below 2500 parts per million (ppm). The IntelliChlor (SCG) cell will not produce chlorine until additional salt is added manually.

**HIGH CURRENT:** Check the IntelliChlor (SCG) cell. Refer to IntelliChlor (SCG) User's Guide troubleshooting information.

**CLEAN CELL!!:** Cell has calcium build up and requires cleaning. Refer to IntelliChlor (SCG) User's Guide for cleaning instructions.

**LOW VOLTAGE:** Check IntelliChlor (SCG) cell. Refer to IntelliChlor (SCG) User's Guide troubleshooting information.

**OK - NO ERRORS:** IntelliChlor (SCG) is in normal operating mode.

**About Super Chlorination:** The Super Chlorination feature is used to introduce large amounts of chlorine into the pool water if there has been heavy rain fall, many bathers in the pool, cloudy water conditions, etc. When Super Chlorination is enabled, the system will switch on the filter pump, set the pool/spa valves to the correct position, and set the IntelliChlor (SCG) to maximum output. This process continues for 24 hours. At the end of the Super Chlorination process, the system will return to normal operation. It is possible to manually stop the Super Chlorination process and switch off the filter pump in the "Circuit On/Off" menu (see page 13). When the filter pump is switched on again, the Super Chlorine process will resume for the duration of time that is left.

## Service Menu (14/14): Service, Timeout, Auto

The Service operation features allow manual control of the SunTouch® Control System for pool service purposes. The active service operating mode (Service Mode or Timeout Mode) is displayed on the main screen.

**Service mode:** This mode allows the auxiliary circuit buttons, filter pump, valves, heater and solar functions to be operated manually. All control panel buttons, remote controllers, and menu scheduled programs are disabled while the system is in Service mode, except for switching off equipment manually for emergencies. If a power outage occurs while the SunTouch Control System is in Service mode, after power is restored the system will power up in Service mode.

**Timeout mode:** Allows manual control of the SunTouch Control System for three (3) hours. After three hours the system will automatically return to normal operation (Auto mode). Manual controls for Timeout mode are same as Service mode. All control panel buttons, remote controllers, and menu scheduled programs are disabled while the system is in manual mode, except for switching off equipment manually for emergencies. If a power outage occurs while the SunTouch Control System is in Timeout mode, after power is restored the system will power up in AUTO mode.

**Auto (automatic) mode:** The SunTouch Control System is in normal operating mode.

To access the Service or Timeout menu settings:

Main Menu 14/14 Service	<b>Menu button:</b> Select the Service (14/14) menu. <b>Right button:</b> Press the button to access the System operation menu.
System Operation [AUTO ]	<b>Up/Down buttons:</b> Select SERVICE or TIMEOUT. <b>Right button:</b> To access the Service or Timeout settings and each of the selections shown below.
System Operation [AUTO ]	<b>Up/Down buttons:</b> Select the setting.
System Operation [SERVICE ]	The Service selections are:
Service Settings F Pump: OFF	<b>F Pump:</b> OFF, ON, HI SPD
Service Settings VLV A, B: POOL	<b>VLV A, B:</b> POOL, DRAIN, FILL, SPA
Service Settings Heater: OFF	<b>Heater:</b> OFF, ON
Service Settings Solar: OFF	<b>Solar:</b> OFF, ON
Service Settings AUX 1: OFF	<b>AUX 1, AUX 2, AUX 3:</b> OFF, ON
Service Settings VLV C: OFF	<b>VLV C:</b> OFF, ON
	<b>Left/Right button:</b> Press the Left or Right button to activate Service or Timeout mode and return to the main status screen. The active service operating mode is displayed on the main screen while in shared equipment, single body, and solar only operating modes.

To exit Service Mode or Timeout Mode:

Service Mode 6:27 AM	<b>Menu button:</b> Select the Service (14/14) menu. <b>Right button:</b> Press the button to access the System operation menu.
Main Menu 14/14 Service	<b>Up/Down buttons:</b> Select AUTO. <b>Left or Menu button:</b> Press the Left or Menu button to return to the main status
System Operation [SERVICE ]	
System Operation [AUTO ]	

## Main Status Screen (Pool/Spa Mode - Single Body System)

Use the SunTouch® Control System display to view the daily operations of your spa or pool. Using the UP arrow button (HI-TEMP) to manually switch the filter pump on and off and activate the heater. LOW temperature control can also be assigned to the UP arrow button. The “HIGH” and “LOW” circuit can be programmed to run at a specific time and heat setting. These circuits are assigned in the “Circuit Functions” menu (see page 26). Before using SunTouch Control System to operate a single body system (pool only or spa only), familiarize yourself with the status screen and control buttons.

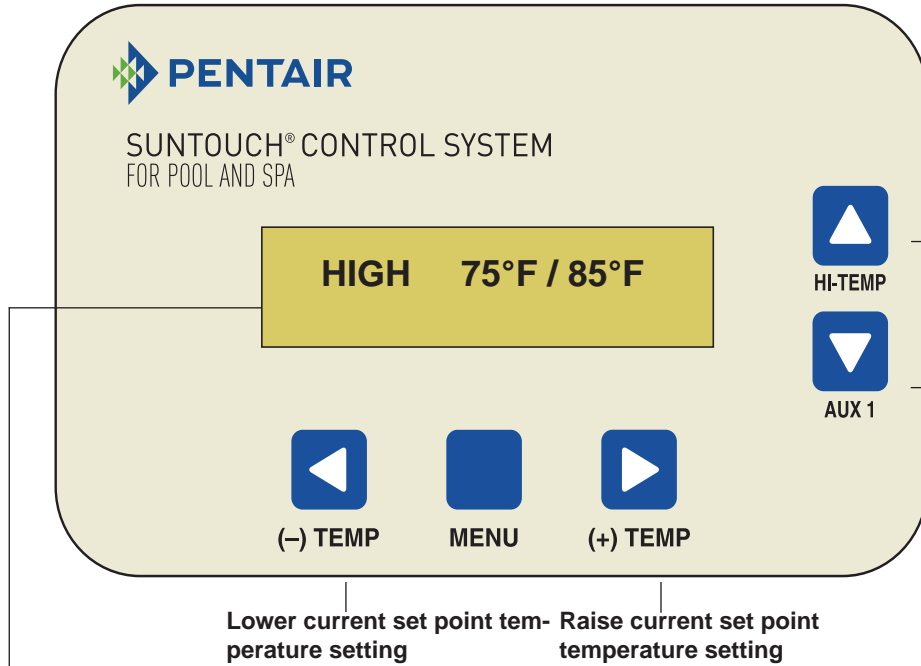

**HI-TEMP/LO-TEMP button:** Turn heater and filter pump on or off. To activate the heater when this button is pressed, first select heat source in the “Heat 2/14” menu (page 14). To manually switch on or off the heater, use “Manual Heat” in the “Heat 2/14” menu. The heat temperature settings are displayed on the main screen. This button can also be assigned for LOW temperature control (see page 37).

**AUX 1:** When this button is pressed, the circuit relay connected to AUX 1 is switched on and the number 1 is displayed on the lower right-side of the screen. AUX 1 can also be switched on and off manually from the “Circuit On/Off” menu (see page 13). Auxiliary functions are assigned in the “Circ. Function” menu (see page 26). AUX 1 can be assigned to operate accessory equipment such as pool and spa lights.

**AIR 74°F**  
**11: 51AM AUX 1** **AIR:** Displays the outside air temperature via the air sensor located near the pool area. This screen toggles between the “Pool” or “Spa” display (see below). To display the air temperature setting, the air sensor must be enabled (see “Advanced” menu on page 24). Degree units are displayed in either Fahrenheit or Celsius. If the top display line displays “SunTouch”, it indicates no spa or pool function is active and the air sensor is not enabled.

**AIR 36°F FRZ**  
**11: 51AM AUX 1** **FRZ:** Indicates the air sensor is connected and enabled, and “Freeze Protection” is active (see page 26).

**HIGH 75°F / 85°F**  
**11:51AM HEATER** **HIGH:** When the Up arrow button is pressed or this circuit is scheduled to operate, the “HIGH” filter pump circuit is switched on and current water temperature settings are displayed with the type heat source being used. “HIGH” and “LOW” are displayed alternatively if both circuits are active.

**LOW 75°F / 85°F**  
**11:51AM HEATER** **LOW:** When the Down arrow button is pressed or this circuit is scheduled to operate, the “LOW” filter pump circuit is switched on and current water temperature settings are displayed with the type heat source being used. “HIGH” and “LOW” are displayed alternatively if both circuits are active.

**HEATER:** Displays the heat source (**Heater, Solar Prf., Solar**) as specified in the “Heat” menu settings (see page 14). If heat is enabled, when the pool filter pump is switched on, the heat source is displayed.

**75° F / 85° F:** Displays the actual spa or pool water temperature (75° F) and the set point temperature (85° F) as set in the “Heater” menu (see page 14). To adjust set temperature setting use the (-) TEMP and (+) TEMP buttons.

**Time:** Displays the SunTouch Control System time as set in the “Clock” menu setting (see page 19).

**AIR 77°F**  
**11: 51AM AUX 123** **AUX 1 2 3:** Displays AUX 1, 2, 3 (lower line) when these auxiliary relay circuits are switched on. Press the AUX 1 (1) button to manually switch auxiliary 1 on or off. AUX 2, and AUX 3 can be switched on and off manually from the “Circuit On/Off” menu (page 13). Auxiliary functions are assigned in the “Circ. Function” menu (page 26).

**AIR 77°F**  
**11: 51AM AUX D** **AUX D:** “D” indicates the selected circuit (AUX 1,2,3) is in “delay” mode. For example, if AUX 2 is assigned to a cleaner, when the auxiliary circuit 2 is switched on via the “Circuit On/Off” menu setting, this will force the filter pump on for five (5) minutes before the cleaner pump switches on. See “Circuit Functions Menu” (page 26) for more information.

## High/Low Temperature Circuit Control (Single Body System)

### HI-TEMP / LO-TEMP Circuit Controls

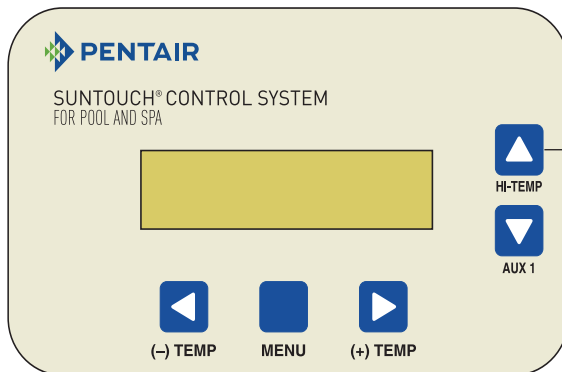

For SunTouch® Control System single body systems (pool only or spa only), the **HI-TEMP (UP arrow)** button is used to switch the heater (regardless of the Heat menu setting) and filter pump on and off. Typically this circuit is used with the “Manual Heat” feature (see below) for on-demand spa water heat. The heat temperature settings are displayed on the main screen. The heater is active when the set temperature is higher than the water temperature. The heater will switch off when the water temperature rises above the set temperature. The heat temperature settings are displayed on the main screen.

The LO-TEMP on and off control is made from the Heat menu setting. For the SunTouch Control System single body systems (pool only or spa only, see page 35), the LO-TEMP menu setting is used to switch on and off the heat source and filter pump. A heat selection must be selected in the Heat menu before the heater is activated. The “Manual Heat” setting does not function with the LO-TEMP circuit. The heater is active when the set temperature is higher than the water temperature. The heater will switch off when the water temperature rises above the set temperature.

#### SunTouch® Control System Single Body system notes

- The SPILLWAY circuit selection in the Circ.Functions menu has no function.
- When using a 2-Speed relay, AUX 3 is assigned to the “HIGH” circuit.

#### Setting up SunTouch® Control System to operate as a Single Body system

To setup the SunTouch control system as a “Single Body” of water system (pool only or spa only):

Main Menu 8/14  
Advanced

**Menu button:** Select the Advanced menu (8/14).

**Right button:** Select the System Type setting.

System Type  
Single Body

**Up/Down button:** Select Single Body to configure SunTouch Control System as a single body of water system.

**Left button:** Press the Left button to return to the main status screen.



## Pool/Spa Mode (Single Body of Water) Menus

For menu descriptions, see “The Pool/Spa Mode Menus” on page 13.

<b>Circuit On/Off</b> 1/14	<b>Filter Pump:</b> [Circuit On/Off - LOW: On/Off] - Default Off (page 13) AUX 1, AUX 2, AUX 3 [On/Off], FT 1, FT 2, FT 3, FT 4 [On/Off]
<b>Heat</b> 2/14	<b>LOW Temp</b> [40° F - 104° F] or [4° C - 40° C] (page 14) <b>LOW Heat</b> (Source) [Off, Heater] [Solar, Solar Prf - displays if "Solar" is enabled in "Solar" menu] (page 19) <b>HIGH Temp</b> [40° F - 106° F] or [4° C - 41° C] <b>HIGH Heat</b> (Source) [Off, Heater] [Solar, Solar Prf - displays if "Solar" is enabled in "Solar" menu] (page 19) <b>Manual Heat:</b> [ON/OFF] - Default On (page 15)
<b>Delay Cancel</b> 3/14	<b>Press Right button to cancel delays</b> - [Delayed Cancelled] (page 16)
<b>Schedules</b> 4/14	<b>Schedules:</b> [LOW, HIGH, AUX 1 - 3, FT 1 - 4] (page 17) <b>Program:</b> 4/4 [Add, Edit, Skip, Delete] <b>Schedule:</b> Start/Stop [08:00A - 05:00P] 12:00 AM - 11:59 PM - 12 Hours
<b>Clock</b> 5/14	<b>Time Set:</b> 06:00 AM [Hour/Minutes - AM/PM] (page 19)
<b>Solar</b> 6/14	<b>Solar Status:</b> Enabled [NO / YES] - Default No (page 19 - 20) <b>Heat Start Temp Diff:</b> Temp Diff [6 %] - [6-9%] - <b>Heat Stop Temp Diff:</b> Temp Diff [3 %] - [3-5%] <b>Heat Pump:</b> [Yes/No] - Default No - <b>Cooling Enabled:</b> [Yes/No] - <b>Cool Start Temp Diff:</b> Temp Diff [6 %] - <b>Cool Stop Temp Diff:</b> Temp Diff [3 %]
<b>Valves</b> 7/14	<b>Valves Circuit:</b> [HIGH, LOW, AUX1 - 3, FEATURES 1 - 4, SOLAR, HEATER, FREEZE, NONE] (page 21) [SOLAR displays if "Solar" is enabled, see page 19]
<b>Advanced</b> 8/14	<b>Heater Delay:</b> [No/Yes] (page 22) <b>Temp Units:</b> [FAHRENHEIT / CELSIUS] <b>Calibrate Water:</b> Temp 10° F - <b>Calibrate Air:</b> Temp 90° F - <b>Calibrate Solar:</b> Temp 100° F - <b>Air Sensor:</b> [On/Off] - (Default On) - See page 24 - <b>System Mode:</b> [Pool/Spa, Solar Only*] <b>System Type:</b> [Shared Equipment, Single Body] - <b>Circuit Timeout:</b> 12 hours [1 - 23 Hours] <b>Reset Factory:</b> [Erase ALL? (No/Yes)]
<b>Diagnostics</b> 9/14	<b>Firmware Rev:</b> (Displays the system firmware revision level) (page 25) <b>Solar Temp:</b> [Fahrenheit/Celcius - Status display only] - (Displays if Solar is enabled in Heat menu) <b>Self Test:</b> [Yes/No] - <b>IntelliChem</b> (view pH and ORP levels)
<b>Circ. Functions</b> 10/14	<b>Low Circuit:</b> Freeze [Off/On] - Default Off (page 26) - <b>High Circuit:</b> Freeze [Off/On] <b>AUX 1 - 3 Circuit:</b> [Generic, Cleaner, Spillway, Floor Cleaner, Heater, Solar] - <b>Freeze:</b> [Off/On]
<b>QuickTouch</b> 11/14	<b>QuickTouch</b> - Assign 1 - 4 circuits (page 28) <b>Button 1, 2, 3, 4</b> [High, Low, AUX 1- 3, FEATURE 1 - 4, Heat Boost, Heat Enabled, None]
<b>Pumps</b> 12/14	<b>SINGLE SPEED - TWO SPEED - INTELLIFLO VS - INTELLIFLO VSF - INTELLIFLO VF</b> (page 29 - 32) <b>TWO SPEED - Pump Circuits 1-4:</b> [Spa, Pool, AUX1- 3, FEATURE 1 - 4, Solar, Heater, Pool Heat, Spa Heat, Freeze, Pool/Spa, Solar/HT] <b>INTELLIFLO VS - Circuit Setup (1-8):</b> [Spa, Pool, AUX1- 3, FEATURE 1 - 4, Solar, Heater, Pool Heat, Spa Heat, Freeze, Pool/Spa, Solar/HT, None] 1-8 - RPM 1000 default [400 - 3450] - <b>Assign Speeds (1-8):</b> RPM 1000 default [400 - 3450 RPM] <b>INTELLIFLO VF - Circuit Setup (1-8):</b> [Spa, Pool, AUX 1- 3, FEATURE 1- 4, Solar, Heater, Pool Heat, Spa Heat, Freeze, Pool/Spa, Solar/HT] - <b>Assign Flows: (1-8)</b> GPM 30 default [15 - 130 GPM] - <b>INTELLIFLO VSF - Pump Params Menu: CIRC. SETUP (1-8)</b> [None, Spa, Pool, AUX1- 3, FEATURE 1 - 4, Solar, Heater, Pool Heat, Spa Heat, Freeze, Pool/Spa, Solar/HT] - GPM/RPM mode: GPM/PSI [15 - 130 GPM - PSI: Disable/1-30], RPM 1000 default [400 - 3450 RPM]
<b>IntelliChlor</b> 13/14	<b>IntelliChlor:</b> Enable [No / Yes] (page 32) <b>Pool %:</b> (0% - 100%) - 50 (Default) - <b>Spa %:</b> (0% - 100%) - 8 (Default) <b>Super Chlor:</b> (No/Yes) - 23 (Default) - <b>Run Hours:</b> (0 -72) - 0 (Default) <b>IntelliChlor - Salt Level:</b> Displays current salt level (xxxx) ppm - <b>Status:</b> OK - NO ERRORS (SUPER CHLORINATE, COM LINK ERROR, CHECK FLOW / PCB, LOW SALT, VERY LOW SALT, HIGH CURRENT, CLEAN CELL!!, LOW VOLTAGE)
<b>Service</b> 14/14	<b>System Operation:</b> [AUTO, SERVICE, TIMEOUT] (page 35) - <b>Service Settings:</b> <b>F Pump:</b> On/Off, HI SPD - <b>VLV A, B:</b> Pool, Drain, Fill, Spa - <b>Heater:</b> Off/On, <b>Solar:</b> Off/On, AUX 1 - 3, FT 1 - 4, <b>VLC:</b> (On/Off) - AUTO - [Solar On/Off - only]

Note: (\*) See page 6 for "SOLAR ONLY" menu.

## Section 2

# Installation and Setup

---

### SunTouch® Control System Installation Steps Summary

The recommended SunTouch® Control System installation steps are:

- 1 Review, prepare and install SunTouch Power Center (pages 49):** Review high voltage connections. Prepare and install the SunTouch Control System Power Center at the equipment pad. AC power for SunTouch should be provided from the main-panel circuit breaker located at the house.
- 2 Remove SunTouch Control System Power Center knockouts, install conduit and low voltage wire to the Power Center (page 53).**
- 3 Install Auxiliary Relays and Valve Actuators (page 58-60):** Install auxiliary relays, valve actuators, and connect actuator cables to the SunTouch control system motherboard (VLV A, VLV B, or VLV C).
- 4 Install Temperature Sensors and Heat Thermostat (page 61):** Install water and air sensors. Connect sensor cable plugs to the SunTouch Control System motherboard.
- 5 Optional Equipment - Connecting IntelliChlor® Salt Chlorine Generator and IntelliFlo® VS and VF Pumps (page 75-77):** Connect the IntelliChlor (SCG) and IntelliFlo VS or IntelliFlo VF pumps communication cable to the SunTouch control system motherboard to connector COM PORT.
- 6 SunTouch Control System Start-up (page 65):** Perform a system start-up procedure.
- 7 Setting up SunTouch Control System after equipment installation using main menu (page 66):** Configure the SunTouch control system control panel via the main menu for installed equipment.

### Required Tools

- 3/16 in. diameter drill (for mounting the SunTouch Control System Power Center)
- 3/8 in. diameter drill (for mounting water temperature sensor)

## SunTouch® Control System Solar Package Contents

SunTouch® Control System Solar (P/N 520819)

- SunTouch Control System Power Center - QTY 1
- Valve actuator assembly (P/N 263045) - QTY 1
- Solar valve (P/N 263047) - QTY 1
- Temperature sensors (20 ft. water, solar 40 inches) - QTY 2

SunTouch Control System Solar with non-solar 3-way valve (P/N 520856)

- SunTouch Control System Power Center - QTY 1
- Actuator (P/N 263045) - QTY 1
- Valve, three-way (P/N 263026) - QTY 1
- Temperature sensors - (20 ft. water, solar 40 inches) - QTY 2

SunTouch Control System Booster Pump Version (P/N 520857)

- SunTouch Control System Power Center - QTY 1
- Relay (P/N 520106) - QTY 1
- Temperature sensors (20 ft. water, solar 40 inches) - QTY 2



SunTouch® Control System Power Center

## SunTouch® Control System Contents

SunTouch Control System Single Body (P/N 520859)

- SunTouch Control System Power Center - QTY 1
- Relay (P/N 520106) - QTY 3
- Temperature sensors (20 ft. water, air 40 inches) - QTY 2

SunTouch Control System Pool/Spa - Shared Equipment (P/N 520820)

- SunTouch Control System Power Center - QTY 1
- Actuator (P/N 263045) - QTY 2
- Relay (P/N 520106) - QTY 3
- Temperature sensors (20 ft. water, air 40 inches) - QTY 2

### Accessories

- QuickTouch® Wireless Remote kit (P/N 520148)
- Relay (P/N 520106)
- Temperature sensor (P/N 520272)
- Two-Speed pump relay (P/N 520198)
- Emergency Shut-Off Switch with audible alarm (P/N ES03)

### Replacement Parts

- SunTouch Control System Power Center door (P/N 520814Z)
- SunTouch Control System Power Center door Latch (P/N LXLATCH)
- Temperature sensor kit (20 ft.) - (P/N 520272)
- SunTouch Control System Circuit Board (P/N 520645Z)
- QuickTouch Wireless Remote (P/N 520129)
- QuickTouch Wireless Remote antenna replacement (P/N 520241)
- QuickTouch Wireless Remote circuit board assembly (P/N 520419)
- Standard transformer kit (P/N 520841Z)

### Optional Equipment

- IntelliChlor® Salt Chlorine Generator Electrolytic Cell (model IC20 (P/N 520554) or IC40 (P/N 520555))
- IntelliFlo® VS pump (P/N 011013)



CVA-24T Valve Actuator  
(P/N 263045)



PTV-2TS 3-Port Valve  
(P/N 263047)



10k Ohm Temperature Sensor  
(P/N 520272)

# SunTouch® Control System Overview

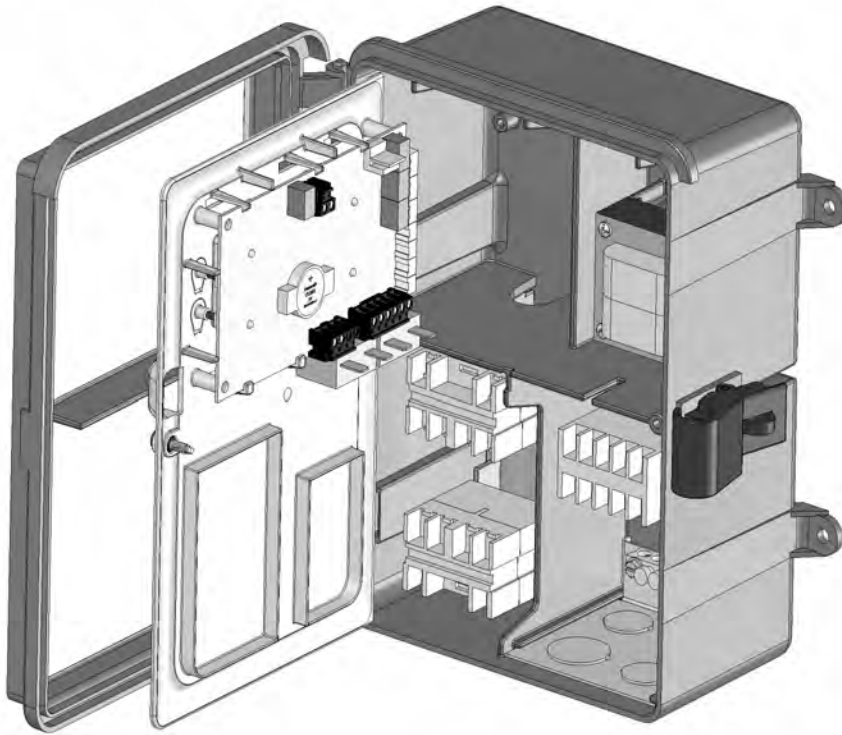

QuickTouch® (QT4)  
Wireless Remote kit  
(P/N 520148)  
(Optional)

Temperature Sensors  
(Water, Air and Solar)

SunTouch® Control System enclosure (with two resettable circuit breakers (18 VAC and 24 VAC).

**Electrical Ratings:**

**Input:**  
120/240 VAC, 60/50 Hz,  
820/410 mA maximum.

**Output:**  
120 VAC, 20 FLA/120 LRA,  
1.5 HP.  
277 VAC, 17 FLA/120 LRA,  
3.0 HP.

- **Pumps**  
Filter, Cleaner, Spa Jet -  
1.5 HP 120 VAC  
3 HP 277 VAC  
20 FLA/120 LRA, 120 VAC  
17 FLA/102 LRA, 277 VAC
- **Pool/Spa Lights**  
1.5 KW 120 VAC Tungsten  
4.8 KW 240 VAC Tungsten  
20 AMP, 277 VAC Ballast
- **Pool/Spa Valve**  
Suction and return.  
24 VAC valve actuator, shared equipment only
- **Valve actuators**  
Valve A (intake), Valve B (return),  
Valve C (Solar)
- **Heat Source**  
Gas, Electric and Solar
- **Relays (3 maximum installed in power center)**  
25 AMP, 277 VAC

**Optional equipment**



- IntelliChlor® Salt Chlorine Generator (SCG)
- IC20 P/N 520554/520556
- IC40 P/N 520555/520556
- Power Center  
P/N 520556



- IntelliFlo® VS Pump (P/N 011013)
- IntelliFlo® VF Pump (P/N 011012)  
(see page 30)

# SunTouch® Control System Power Center (Front View)

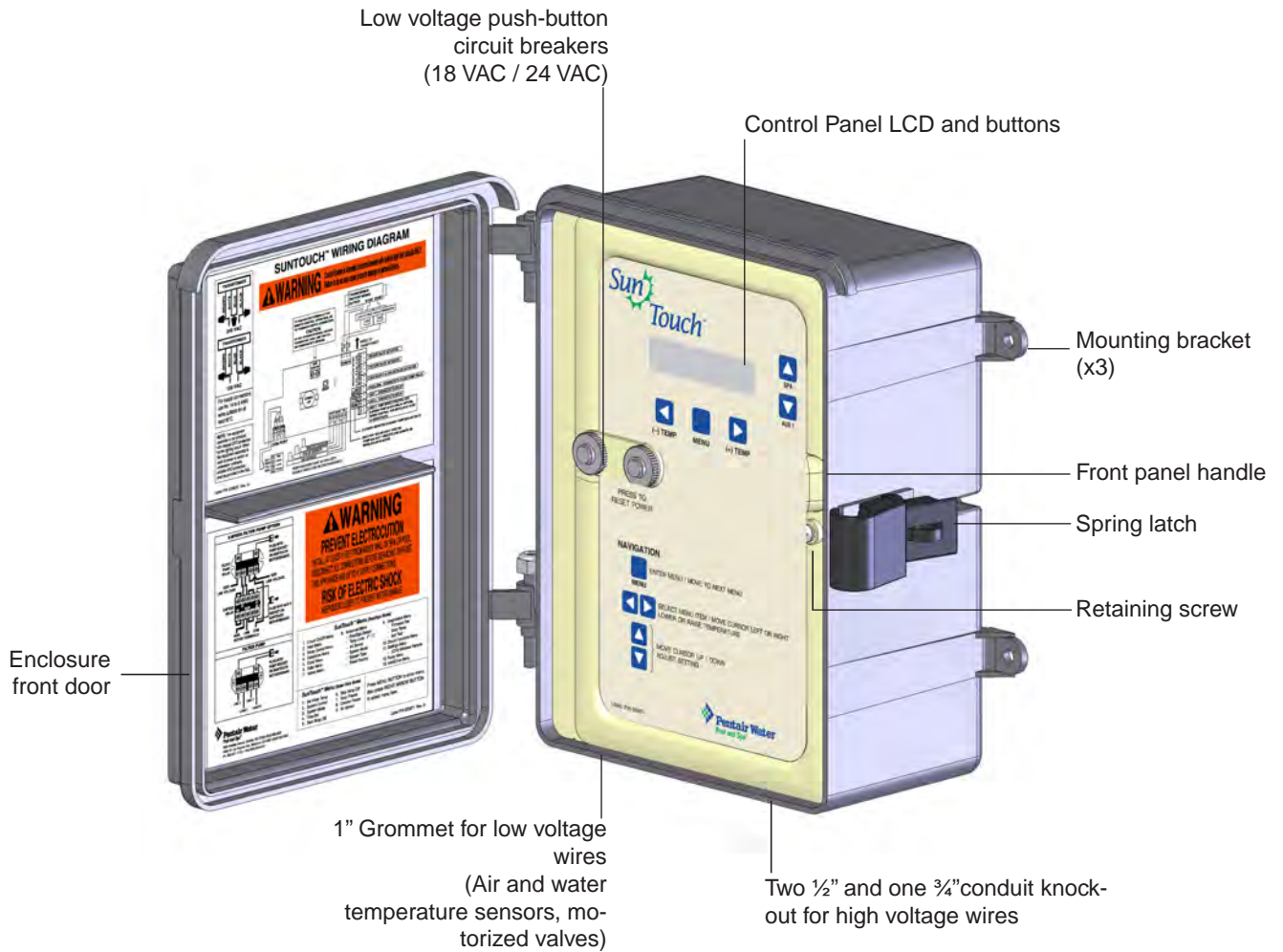

SunTouch® Control System Power Center (Front View)

## Plumbing Requirements

It is important that the pool and spa plumbing system be in accordance with local codes and the Recommended Hydraulic Schematics. Before starting, please review the diagrams and the following recommended guidelines:

- 1 The spa should be at or above the level of the pool.
- 2 If the spa is attached to the pool, provide a dam between the two bodies of water to allow the spa to overflow into the pool. If the spa is not attached to the pool, an overflow, sufficient in size to carry a full pump-flow, must be installed at the water level in the spa.
- 3 Plumb a three-port **Intake Valve** (VLV A) on the suction-side of the filter pump, so that the center port of the valve is connected to the pump inlet. Connect the spa suction to one side of the Intake Valve, and the pool suction to the other side.
- 4 Plumb a three-port **Return Valve** (VLV B) on the return-side of the heater, so that the return water will enter the valve through the center port.

Connect the spa return to one side of Return Valve, and the pool return to the other side.

- 5 If required, install a spa makeup line (consisting of a manual gate or ball valve, for elevated spas install a check valve) to bypass the pool return line. This will enable some of the chemically-balanced water from the pool to cycle through the spa. The manual valve will allow the amount of bypass to be adjusted.
- 6 For systems which incorporate a skimmer, it is possible to balance the amount of suction between the skimmer and main drain for maintenance purposes. This is easily accomplished by installing a manual three-port mixing valve at the suction line. Plumb one port to the skimmer and the other to the main drain.
- 7 If a “non-booster pump” pressure-side pool cleaner is being used, plumb a manual three-port valve between the filter pump and filter, with the third port plumbed to the pool cleaner line, and install a motorized two-port **Pool Cleaner Valve** at this line. The motorized valve will automatically open whenever the SunTouch activates the pool cleaner.

If a booster pump pool cleaner is being used, plumb the booster pump so that its suction-side is connected to the pool return, after the heater, and as close to the ground as practical.

- 8 Plumb the solar feed and return lines between the filter and the heater. Install a three-port valve at the feed line. Use a solar valve (P/N 263047), to allow automatic draining of the panels.
- 9 A solar booster pump should be used when the distance to the panels exceed 200 ft., or the panels are elevated higher than 25 ft.
- 10 Glazed solar panels require a drain valve to allow draining of the panels. This prevents damage from overheating water. Install a drain valve at the solar feed line and connect to the pool fill line.

### Equipment Location

All equipment, with the exception of the spa-side remote, must be located at least 10 ft. from the water's edge.

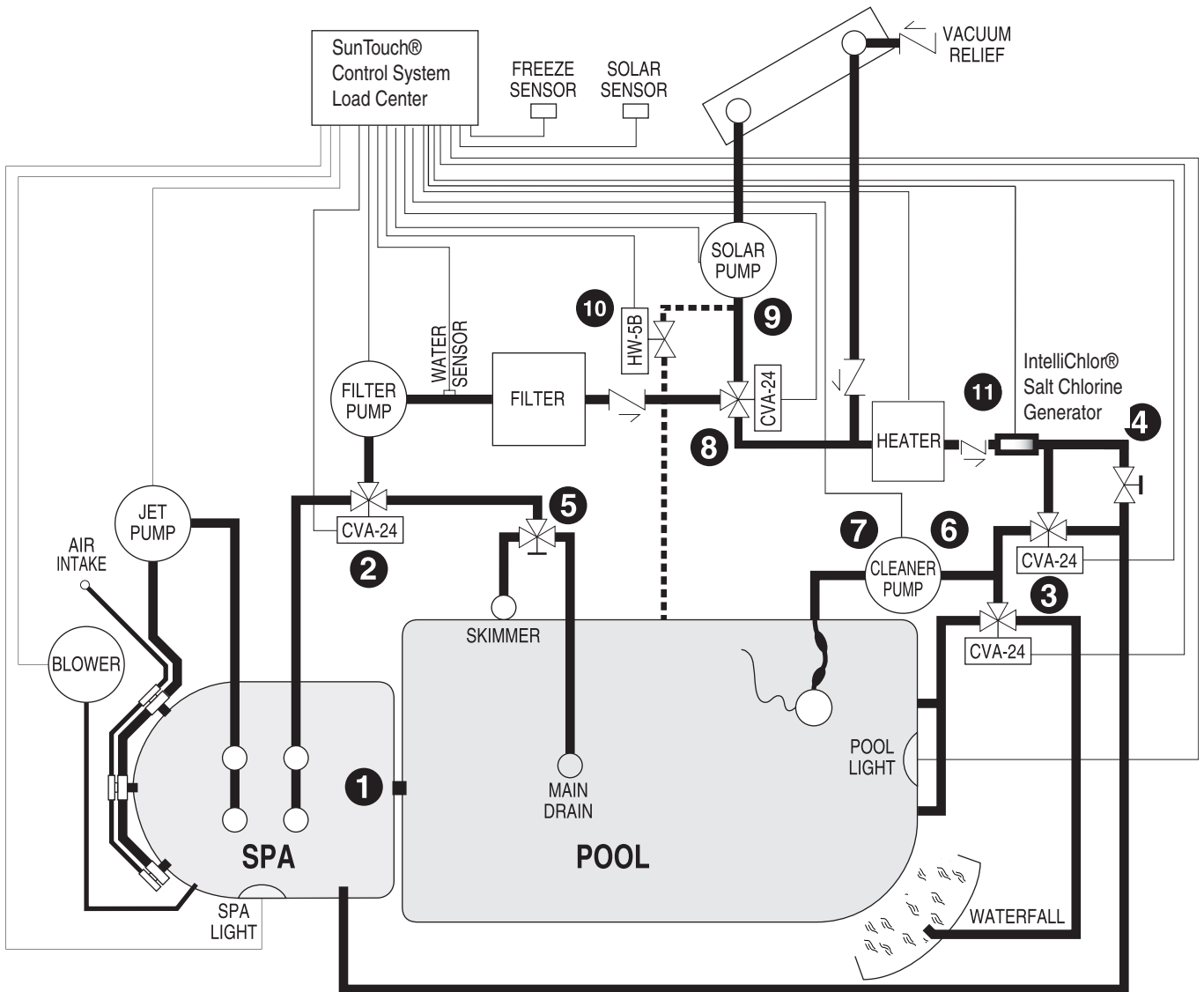

Recommended Hydraulic Schematic for Shared Equipment System

## Solar Hydraulics System

Plumb the SunTouch® Control System solar system in accordance with recommended hydraulics shown below.

- 2" diameter plumbing is advised to ensure maximum flow of water through the solar panels. A solar booster pump should be added if panels are installed at a very high elevation.
- It is recommended that the solar panels are mounted in a way that gravity will allow draining whenever the filter pump is not on.
- For systems with glazed panels, damage can occur from overheating if the filter pump is still running after the solar has turned off. To enable glazed panels to automatically drain whenever the solar turns off (even if the filter pump is still running), a 1/2" motorized solar drain valve should be

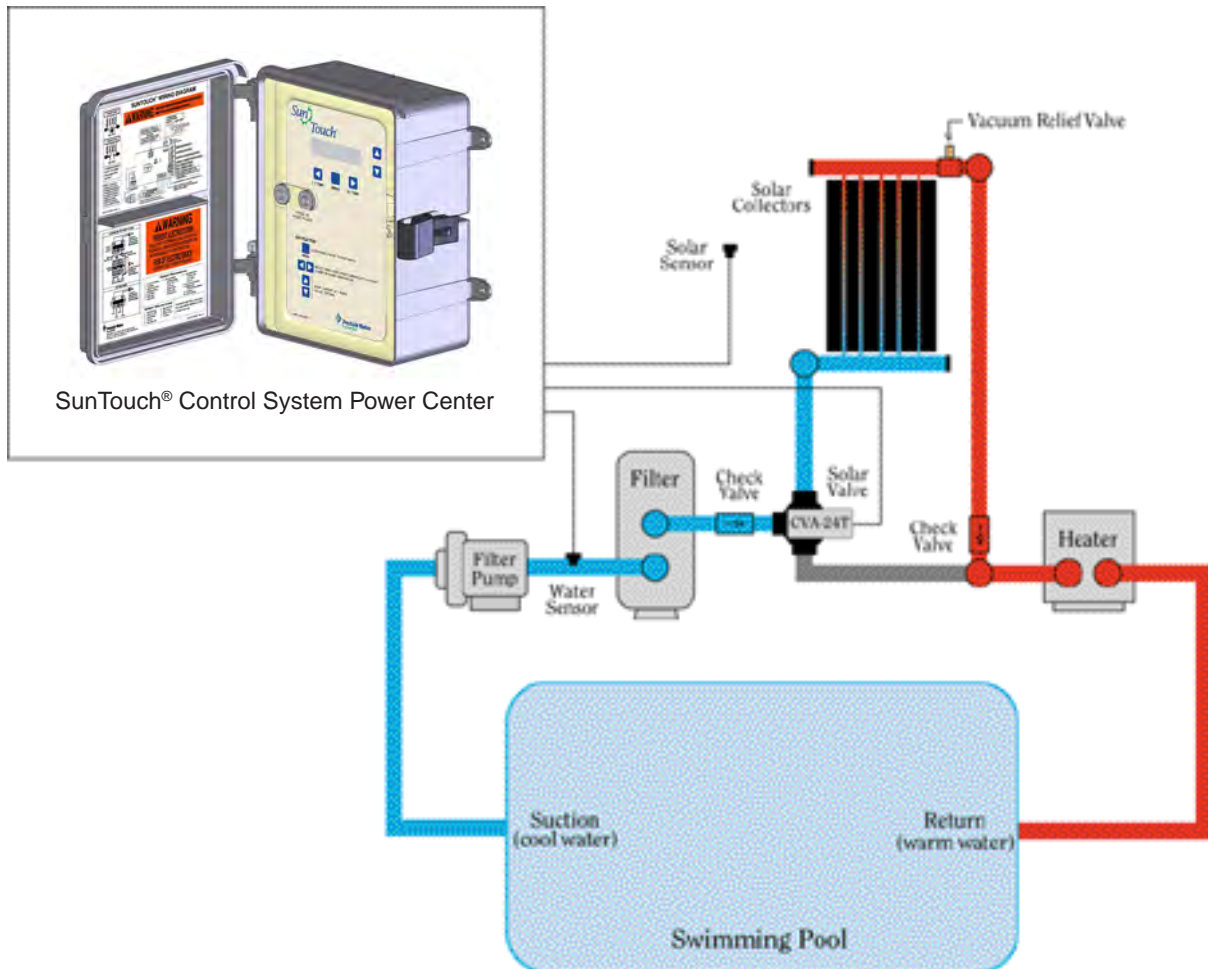

Recommended Hydraulic Schematic for Single Body Equipment System



## SunTouch® Control System Power Center High Voltage Connections



**WARNING** - BEFORE OPENING THE FRONT PANEL OF THE SUNTOUCH® CONTROL SYSTEM POWER CENTER TO ACCESS THE HIGH VOLTAGE COMPARTMENT AND LOW VOLTAGE RACEWAY, SWITCH THE MAIN POWER OFF INTO THE HOME AT THE MAIN CIRCUIT BREAKER BOX, AND SWITCH OFF THE MAIN POWER TO THE SUNTOUCH CONTROL SYSTEM POWER CENTER.

### SunTouch® Control System Power Center Location

Before installing the SunTouch® Control System Power Center read the following guidelines:

- Switch OFF AC power at the main circuit breaker panel, located at the house before high and low voltage connection to the SunTouch Control System Power Center.
- AC power for the SunTouch Control System Power Center must be provided from the main circuit breaker panel located at the house.
- All electrical equipment must be installed at least five (5) feet from pool and/or spa, and comply with all national, state, and local codes.
- Install the SunTouch Control System Power Center no less than five (5) feet from pool or spa near to the pumps, heater, valves, and sensors. Mount the Power Center outside or inside a pool equipment house or other enclosure.
- Before choosing the final location for the SunTouch Control System Power Center, consider the length of the wires and valve wires that have to be connected to the enclosure. Make sure to consider cable lengths for the sensors to the SunTouch Power Center location. The air temperature sensor cable is 3 feet long and the water temperature sensor is 20 feet long.
- Mount the SunTouch Control System Power Center on a flat vertical surface or wall so that the conduit knockouts are located at the bottom of the enclosure. Upper and lower brackets are provided to mount the Power Center to a vertical surface.
- DO NOT mount the SunTouch Control System Power Center horizontally. Water can enter the conduit knockouts and cause damage to the system and an electrical shock hazard.
- Consider the SunTouch Control System Power Center location when routing the conduit carrying the AC power to the SunTouch Power Center, and the conduit that will be run to the high voltage equipment.
- All the SunTouch Control System high voltage double pole relays and are rated at 3HP/30A at 240 VAC (1" HP/30A at 120 VAC).
- Install the SunTouch Control System Power Center so that drainage is provided for all electrical components.
- Motors should have built-in thermal protection.
- Allow for unobstructed access to the front of the SunTouch Control System Power Center for the owner or service personnel.
- The SunTouch Control System Power Center provides grounding screw terminals for grounding all equipment. All equipment including the SunTouch Control System Power Center must be bonded to earth ground.

## Grounding and Bonding to the SunTouch® Control System Power Center

Connect a ground wire from the primary electrical panel to the SunTouch® Control System ground bus bar. Also ground each piece of high voltage (120 VAC or 240 VAC) equipment that is connected to the SunTouch Control System Power Center relays. The SunTouch Control System Power Center must also be connected to the pool bonding system using an 8 AWG (minimum) wire. An earth terminal for bonding is provided on the grounding bus bar inside the Power Center. For input AC wiring information, see page 520.

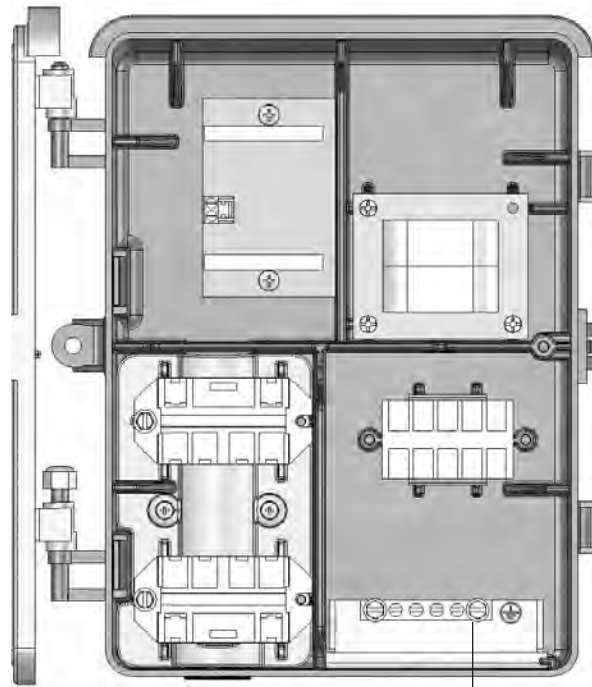

Grounding Bus Bar  
(three terminals for  
relays and one for main  
AC ground wire)

SunTouch® Control System Power Center

# Preparing the SunTouch® Control System Power Center

Before mounting the SunTouch® Control System Power Center, first open the front door and the front panel to access the conduit knockouts and low voltage raceway.

## Opening the front panel

To access the SunTouch Control System Power Center electronics compartment:

1. Unlatch the front door,
2. Loosen the retaining screw on front panel. Open the hinged front panel to access the electronics compartment.
3. Proceed with:
  - **Mounting the SunTouch Control System Power Center**, page 51
  - **Removing Electrical Conduit Knockouts**, page 53
  - **Installing Conduit and Wire to the SunTouch Control System Power Center**, page 54
  - **Transformer Connections**, page 55
  - **SunTouch Control System Motherboard Connections**, page 56
4. After all electrical connections have been completed, close the front panel and secure it with the retaining screw.

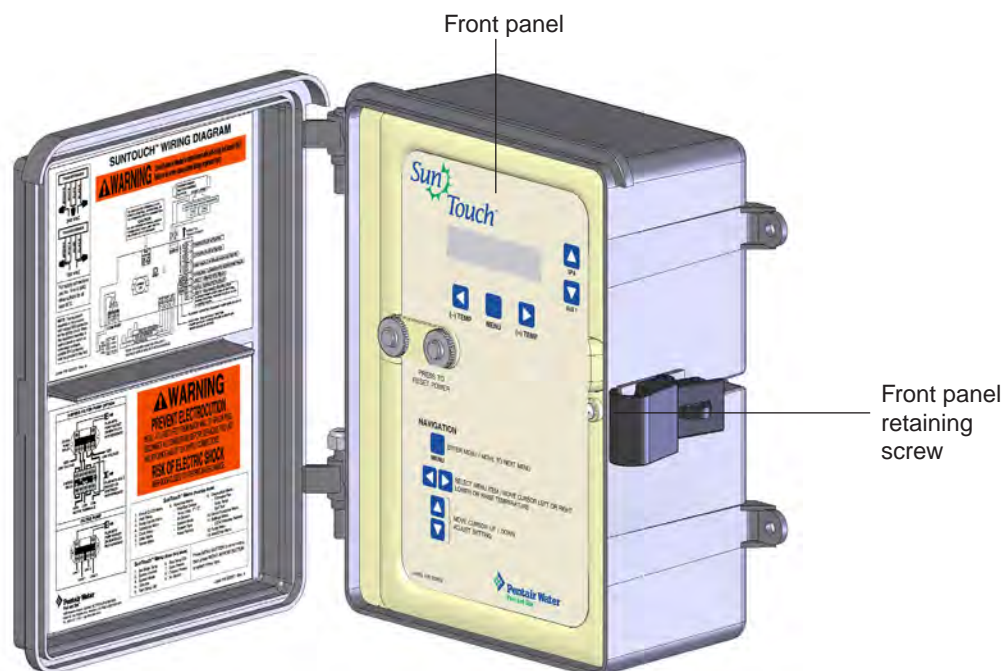

SunTouch® Control System Power Center (Shared Equipment System)

## Mounting the SunTouch® Control System Power Center

The SunTouch® Control System Power Center can be mounted on a flat vertical surface, such as a wall or post.

**Note:** Select a convenient location to mount the Power Center, making sure that the location is greater than 5 feet from the pool or spa and no further than 15 feet from the pool/spa valve.

To mount the SunTouch Control System Power Center:

1. Position the Power Center against the vertical flat surface. If wall anchors are being used, support the Power Center in position (horizontally level and square) against the surface and mark the bracket hole pattern on the wall.
2. Secure the Power Center with three (3) screws in the mounting bracket holes. If using wall anchors, use 3/16" drill and set the anchors and secure the enclosure with screws.



SunTouch® Control System Power Center Mounting Brackets

## Removing Electrical Conduit Knockouts

Before installing the SunTouch® Control System Power Center electrical conduit, read the following recommended guidelines. Remove the power center conduit knockouts as needed:

- Determine the number of low and high voltage circuits being used in the Power Center, the conduit size and runs needed based on the wire size, and the number of conductors within the conduit.
- The conduit knockouts are located underneath of the Power Center. There are three ½” and one ¾” conduit knockouts. It is recommended to use ¾” conduit for the main AC power conductors.
- There is one 1” grommet hole located underneath the power center to access the low-voltage raceway. Use this opening for low voltage cables (sensor wires, IntelliFlo® Pump and IntelliChlor® Salt Chlorine Generator cables).
- Follow manufactures instructions when installing and testing of ground fault circuit breakers (GFCB) and interrupters (GFCI).

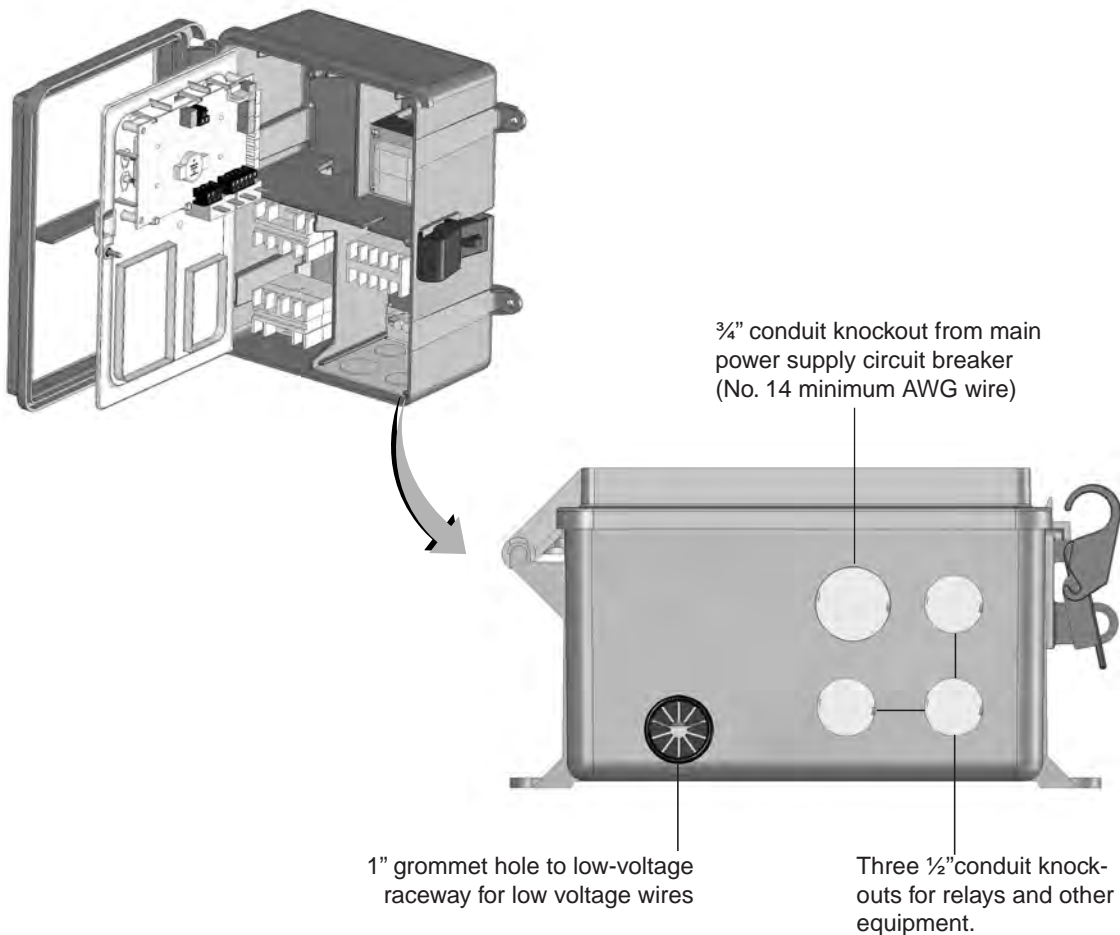

SunTouch® Control System Power Center Conduit Knockouts

## Installing Conduit and Wire to the Power Center

- Use No.14 minimum to No.6 maximum AWG for power relay circuits depending on the power requirement. Be sure to follow all regulation safety codes for the number and size of conductors that can be installed in various sizes of conduit.
- Supply circuit must be protected by suitable circuit breaker.
- To avoid obstruction into the SunTouch® Control System Power Center, when using electrical conduit complete the installation of the conduit before concrete is poured. Also, underground conduit should be positioned in well compacted soil. Ensure that all conduit joints are well sealed and watertight.



**WARNING!** When installing and using this electrical equipment, basic safety precautions should always be followed, including the following:



**IMPORTANT SAFETY INSTRUCTIONS PERTAINING TO A RISK OF FIRE, ELECTRIC SHOCK, OR INJURY TO PERSONS. READ AND FOLLOW ALL INSTRUCTIONS.**

- **DANGER! RISK OF ELECTRIC SHOCK, WHICH CAN RESULT IN SERIOUS INJURY OR DEATH. Before attempting installation or service, be sure the source AC power to the SunTouch Control System Power Center is switched OFF at the circuit breaker located at the house.**
- Grounding (earth bonding) is required. The SunTouch Control System Power Center should be installed by a **qualified professional**.
- **Read Safety Precautions and Important Instructions (page iv and v). Before attempting any electrical wiring, be sure to read and follow Safety Instructions. Wiring should only be performed by a qualified professional.**

**TO AVOID AN ELECTRICAL HAZARD** - Do not connect the power source conductors to the SunTouch Control System Power Center until all electrical connections for all equipment (heaters, pumps, motorized valves, and lights etc.) have been completed.

- Follow manufactures instructions when installing and testing of ground fault circuit breakers (GFCB) and interrupters (GFCI).
- For the main AC power conduit, it is recommended to use the 3/4" conduit knockout located directly under the enclosure.
- Use the 1" grommet low voltage raceway opening located on the underside of the SunTouch Control System Power Center for the temperature sensor wires. For connection information (see page 56).



**CAUTION** All of the electrical wiring methods and materials used to complete the electrical installation of the SunTouch Control System must be in accordance with the current National Electrical Code or the Canadian Electric Code, as well as any local electrical codes in effect at the time of installation.



**CAUTION** All electrical materials used for the SunTouch Control System installation must be accomplished by, or be under the direct supervision of a qualified electrician.

# SunTouch® Control System Transformer Connections

## High Voltage Wiring

The high voltage wiring section is located inside the SunTouch® Control System enclosure. The SunTouch Control System can be connected either to 120 VAC or 240 VAC. The SunTouch Control System should be wired to receive continuous power (connect directly to sub-panel). The maximum current rating is 820/410 mA at 120/240 VAC 60 Hz/50 Hz.

- For the AC power wire into the SunTouch Control System Power Center from the main circuit breaker at the house, use a three conductor cable. Follow manufactures instructions when installing and testing of ground fault circuit breakers (GFCB) and interrupters (GFCI).

Connect input AC wires to the SunTouch Control System Power Center transformer wires as follows:

- **120 VAC:** Connect one wire to the Brown/White wires and one wire to the Blue/Black wires. One wire must be connected to the grounding bar.
- **240 VAC:** Connect one wire to Black wire and one wire to Brown wire. The White/Blue wires are connected together.

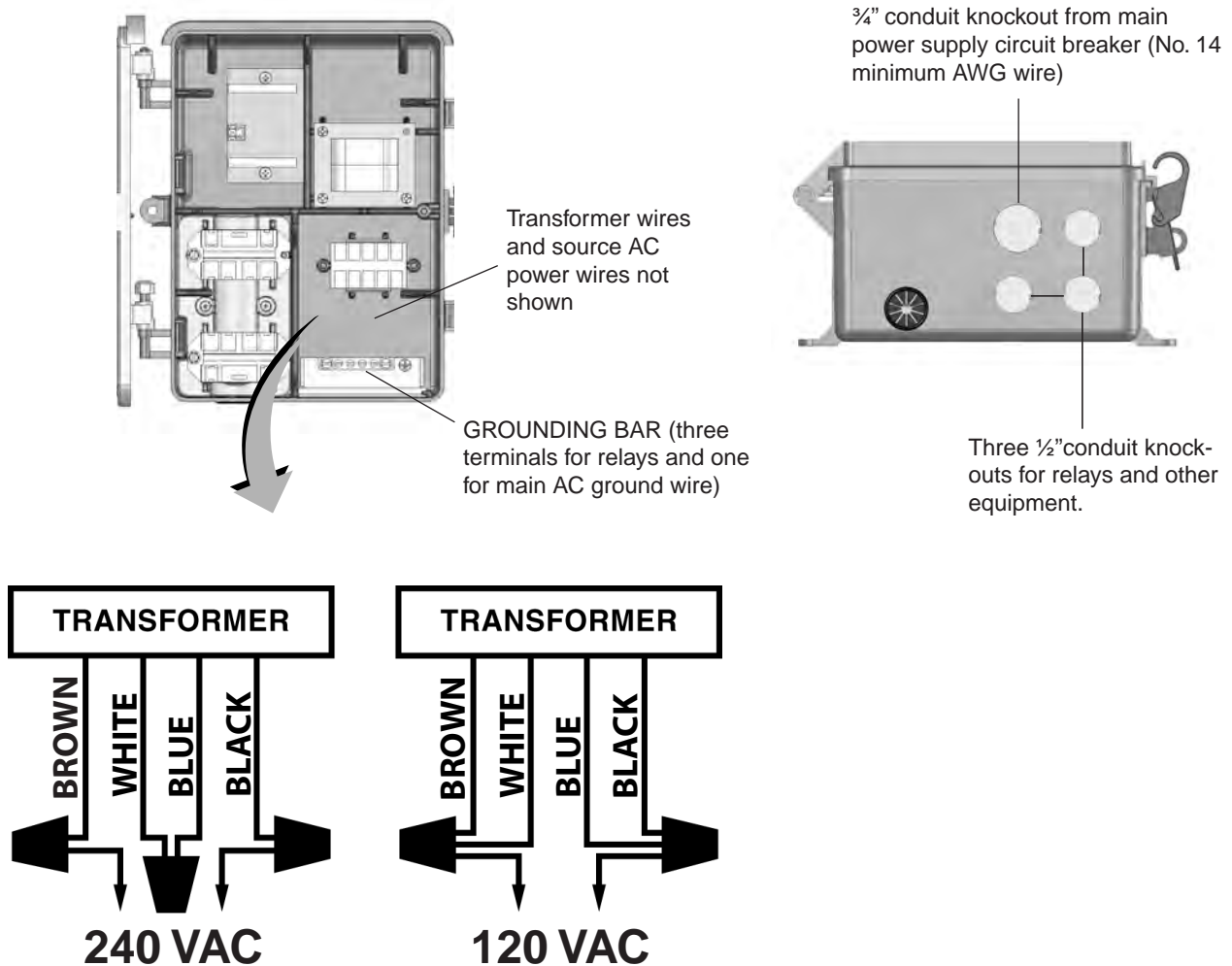

# SunTouch® Control System Motherboard Connections

The SunTouch® Control System motherboard is mounted onto the back of the control panel located in the Power Center. The motherboard provides the voltage connections to switch the filter pump, heater, auxiliary relays, motorized valves, and connections for temperature sensors. To access the motherboard, refer to “Accessing the SunTouch Control System Motherboard,” on page 54.

## Equipment Power

- It is recommended to connect the filter pump relay to an independent circuit breaker. Follow manufactures instructions when installing and testing of ground fault circuit breakers (GFCB) and interrupters (GFCI).
- A maximum of three (3) power relays can be installed in the SunTouch Control System Power Center. Connect pumps and other high-voltage equipment to the power relays.

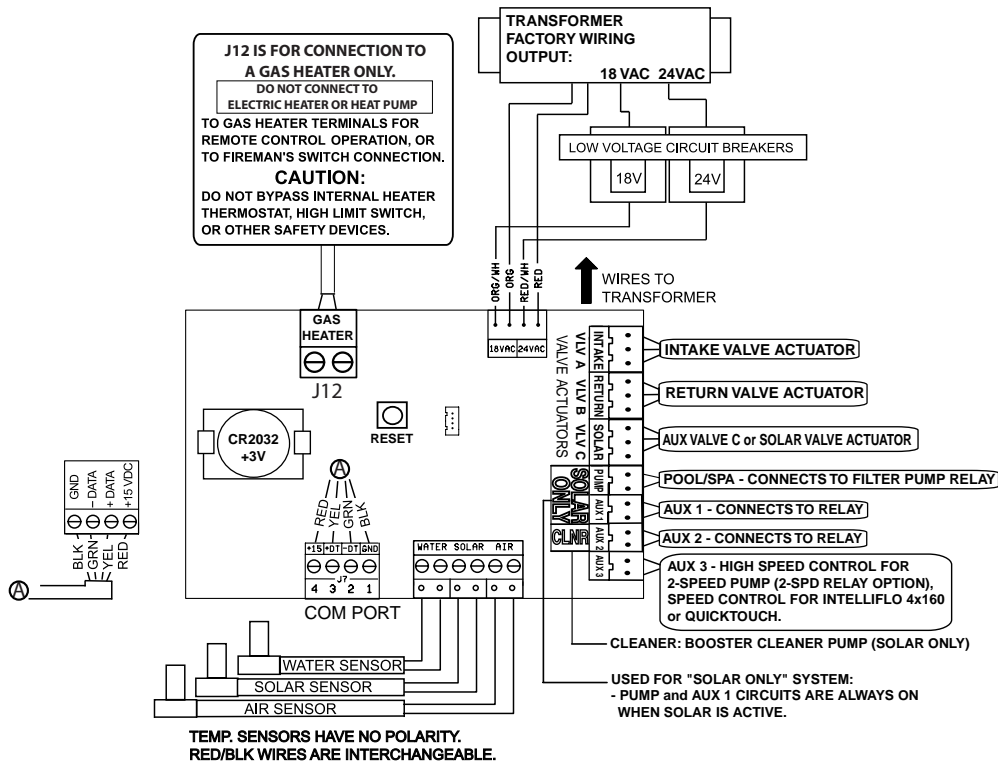

TEMP. SENSORS HAVE NO POLARITY. RED/BLK WIRES ARE INTERCHANGEABLE.

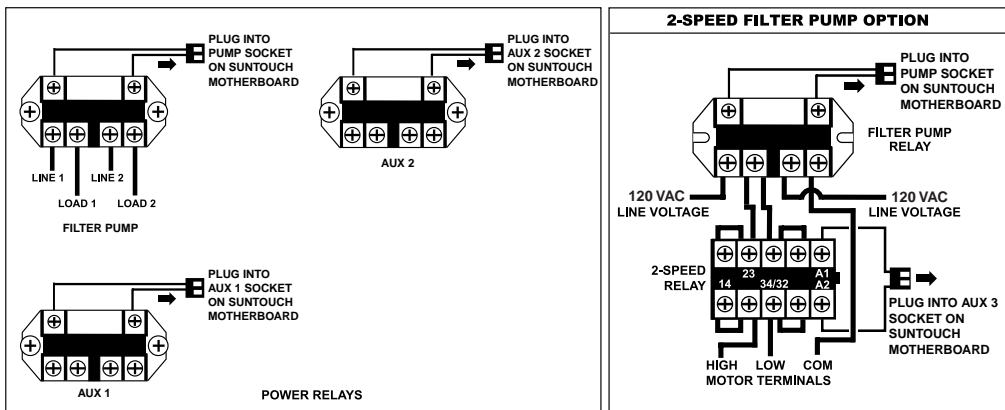

## SunTouch® Control System Motherboard Connections



## Accessing the SunTouch® Control System Motherboard

The SunTouch® Control System motherboard provides connectors for three auxiliary relays, valve actuators and sensors.

To access the SunTouch Control System Power Center electronics compartment:

1. Loosen the retaining screw on the front panel. Open the hinged front panel to access the electronics compartment.
2. Proceed with:
  - **Installing Auxiliary Relays**, page 58
  - **Installing the Valve Actuator**, page 60
  - **Installing and Connecting Temperature Sensors**, page 61
  - **Connecting SunTouch Control System to a Gas Heater**, page 62
3. After all electrical connections have been completed, close the front panel and secure it with the retaining screw.

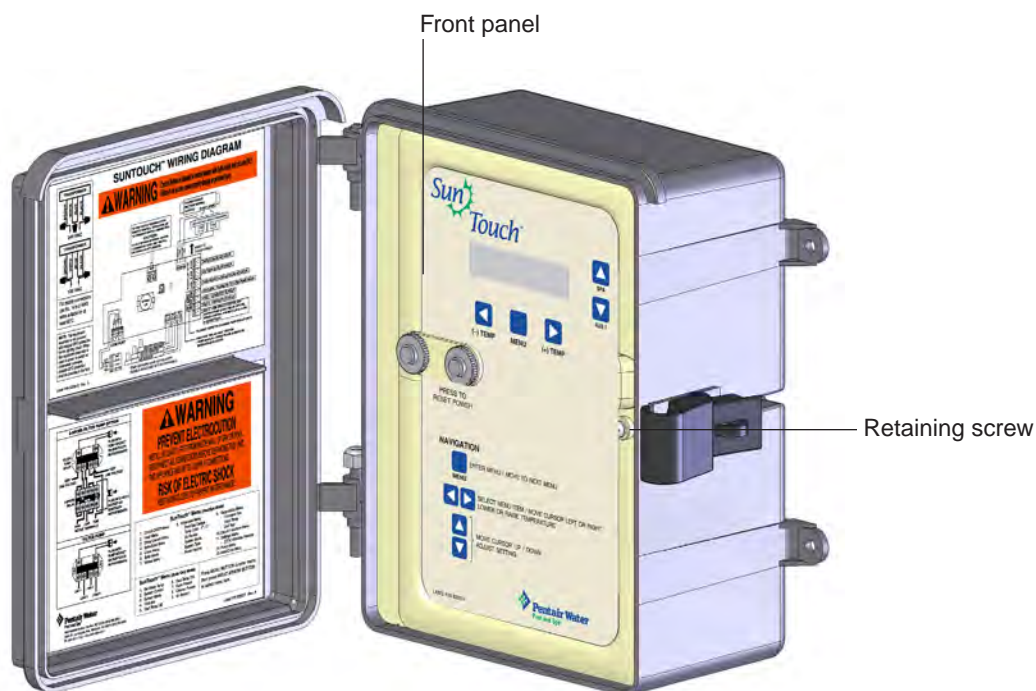

SunTouch® Control System Power Center (Shared Equipment System)

## Installing Auxiliary Relays

A maximum of three standard auxiliary relays can be installed in the SunTouch® Control System Power Center. Depending on the SunTouch Control System kit, relays may not be included in the kit. Relays must be installed at the site. When using a 2-Speed pump, the optional 2-Speed relay (P/N 520198) can be installed, replacing the standard relay which is located in the right-side of the Power Center. For more information about SunTouch Control System kits, see page 40. All SunTouch control System high voltage double pole relays are rated at 3HP/30A at 240 VAC (1½ HP/30A at 120 VAC).

### Relay locations

A standard relay can be installed in any one of the three locations provided in the SunTouch Control System Power Center with the exception of the an optional 2-Speed relay, which can only be installed in the right-side compartment of the Power Center. Power Center relay locations are shown below.

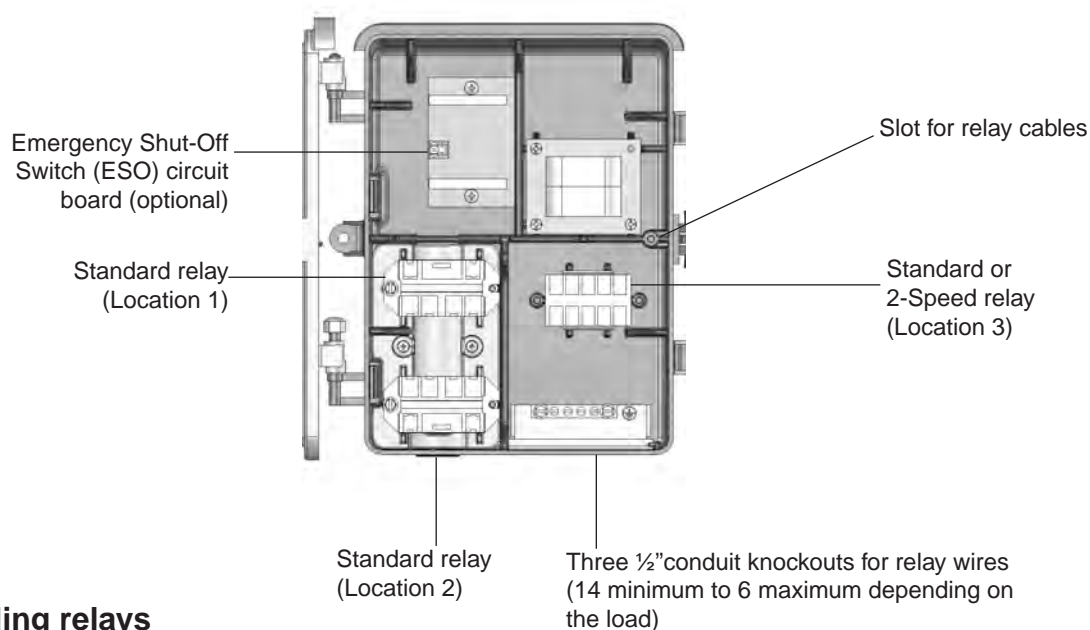

### Installing relays

To install a standard relay in the SunTouch Control System Power Center:

1. **Standard relay (Location 1):** Position the relay coil up in the relay compartment at about a 30 degree angle. Slide the tip of the relay flange under head of the left-side screw. Rotate the relay upward to align the right-side flange with the screw hole. Using a 1/4 in nut driver, secure the relay in place with the retaining screw.

**Standard relay (Location 2):** Position the relay (coil facing upward) in the relay compartment at about a 30 degree angle. Slide the tip of relay flange under head of the left-side screw. Rotate the relay downward to align the right-side flange with the screw hole. Using a 1/4 in nut driver, secure the relay in place with the retaining screw.

**Relay Test button:** For testing relay connectivity, with power applied, press the lever on the top (line/load side) of the relay.

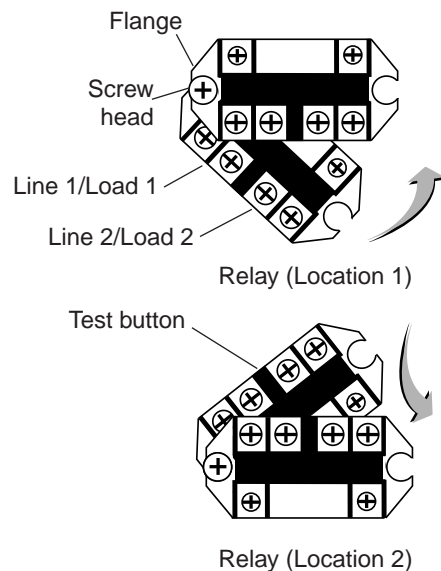

## Installing relays (Continued)

**Standard relay (Location 3):** Position the relay (coil facing upward) on top of the mounting studs. Align the relay flanges with the screw holes. Using a 1/4 in nut driver, secure the relay in place with the two retaining screw.

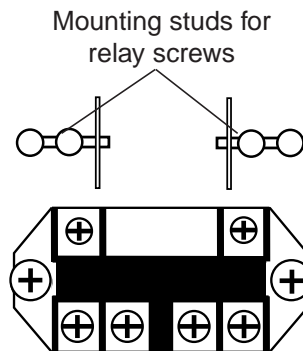

**2-Speed Relay (location 3):** Position the relay bracket on top of the mounting studs. Align the bracket with screw holes. Using a 1/4 nut driver, secure the bracket with the two retaining screws. Insert the relay (coil facing to the right-side) into the relay bracket and snap in place.

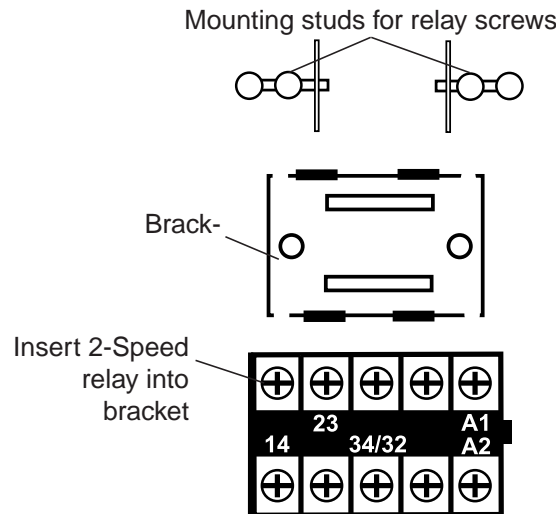

- Route the relay cable into the slot between the low voltage compartment and the transformer compartment to the SunTouch® Control System motherboard.

**Note:** If there is an Emergency Shut-Off Switch (ESO) circuit board installed in the SunTouch Control System Power Center, connect the relay wires to the ESO circuit board. For more information, see “Emergency Shut-Off Switch Installation,” on page 73.

- Connect the relay plugs onto the **PUMP, AUX 1 or AUX 2** two-pin socket on the motherboard.

**2-SPEED RELAY CONNECTION:** The 2-Speed relay cable plug is connected to AUX 3 which controls the pump’s high speed output. The AUX 3 circuit output can only be used to control the following: 2-Speed pump relay, one of the four speeds (RPM) of an IntelliFlo® VS Pump or the flow rate (GPM) of an IntelliFlo VF Pump. For installation and operation information, refer to the Two-Speed Relay User’s Guide (P/N 520210).

**Note:** The IntelliChlor® Salt Chlorine Generator and IntelliFlo Pump does not require a relay connection, it connects to the COM Port (J11) connector on the SunTouch Control System motherboard.

**Note:** For SunTouch Control System motherboard wiring connections, refer to “SunTouch Control System Motherboard Connections,” on page 53.

## Installing Valve Actuators

For shared equipment systems there are two motorized valve actuators (CVA-24T, P/N 263045) included with the SunTouch® Control System kit.

To install a valve actuator:

1. Remove the valve knob, handle and the four screws, from the valve cover (indicated with arrows).
2. Align the splines of the actuator shaft over the shaft of the valve.
3. If the actuator is not aligned with the mounting holes on the valve cover, rotate the actuator (while still attached to the valve) until the actuator is positioned correctly over the valve.
4. Secure the actuator with the screws provided. Only use self-tapping screws when required.
5. Mount the valve handle and knob onto the actuator.

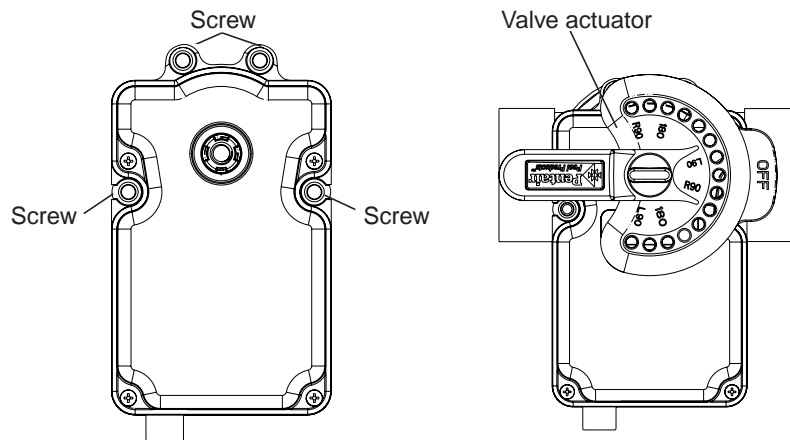

6. At the SunTouch® Control System Power Center, route the cable up through the 1" grommet and low voltage raceway to the motherboard (see page 43).
7. **Connecting of valve actuators to the SunTouch Control System Motherboard (see page 53):**
  - Connect **VALVE A** cable plug into the **IN-TAKE** (suction) 3-pin socket.
  - Connect **VALVE B** cable plug into the **RETURN** 3-pin socket.

*Note:* For more information, see Item 2 and 3 of Plumbing requirements on page 43 □ 1. Excess cable can be coiled in the SunTouch Control System enclosure low voltage raceway. Do not coil the wire in upper low voltage compartment.

**For Solar Heating:** Use **VALVE C** for a solar valve actuator when solar heating is being used.

### Adjusting the valve position

If the valve rotates to the wrong position, adjust the switch on the back of the actuator between ON1 and ON2 positions. This will rotate the valve to the correct position. The following diagram shows the standard plumbing and valve actuator position.

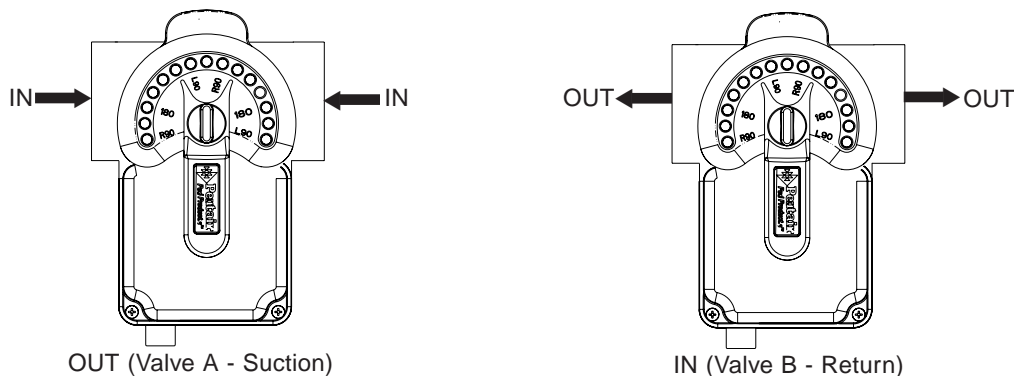

# Installing and Connecting Temperature Sensors

## Water Temperature Sensor

To install the water sensor:

1. Select a convenient location to mount the water sensor in the plumbing system between the filter pump and filter. Drill a 3/8" diameter hole in one side of the pipe,
2. Insert tip of sensor into the hole. Use the band clamp to secure the sensor to the pipe. Tighten the clamp just enough so that the o-ring begins to flatten. Do not overtighten
3. Run 22-gauge two-conductor cable (included) between the sensor and the SunTouch® Control System motherboard. Route the wire up through the low voltage raceway to the motherboard.
4. Fasten the cable to the plumbing with cable ties.
5. Cut off the excess wire and the strip conductors ¼ inch. Use waterproof connectors (provided) to connect the sensor to cable. Insert the wires into the **WATER SENSOR** screw terminals (**J9**) on right-side of the motherboard. For the SunTouch Control System motherboard wiring connections, refer to “SunTouch Control System Motherboard Connections,” on page 53.

## Ambient Air Temperature Sensor (for freeze protection)

The SunTouch Control System will automatically detect an installed air sensor to protect the system if freezing conditions occur. By default, the air sensor is always ON. Freeze protection for a “Solar Only” system requires an additional air sensor (P/N 520272). To disable the air sensor, see “Advanced Menu (8/14): Air Sensor” on page 24.

To install the air sensor:

1. To avoid freeze damage to pool and spa equipment, mount the sensor on a flat surface in a shaded area, in the open air, to assure proper temperature readings. If possible, mount the sensor near the SunTouch Control System Power Center. The SunTouch Control System main screen displays the current ambient air temperature.
2. Route the wire through the low voltage raceway to the motherboard in the power center.
3. Cut off the excess wire and the strip conductors ¼ in. Insert the wires into the **AIR** screw terminals (**J9**) on right side of the motherboard.

## Solar Temperature Sensor

Freeze protection for a “Solar Only” system requires an additional solar sensor (P/N 522101). To disable the air sensor, see “Advanced Menu (8/14): Air Sensor” on page 24. Run a two-conductor cable between the sensor and the SunTouch Control System Power Center. The maximum sensor cable length is 300 ft from the SunTouch Power Center.

To install the solar sensor:

1. Mount the sensor on a flat surface, with the same exposure to sun as the solar collectors (next to the collectors is recommended) or any sunny location. Do not let the sensor touch the panels. **WARNING: DO NOT DRILL HOLE AND CLAMP SENSOR INTO SOLAR PIPE.** For glazed panels, install the sensor between collector and glazing.
2. If necessary, splice a two-conductor extension wire to the sensor. Run two-conductor cable between the sensor and the SunTouch Control System Power Center. Use waterproof connectors to connect the sensor to the cable. Use twisted pair 20 AWG outdoor rated sensor wiring and be sure the wire connections are protected from the environment. Use shielded cable for long runs (300 ft. total wire length maximum) or runs near other electrical wiring.
3. Strip the conductors ¼ in. Insert the wires into the **SOLAR SENSOR** screw terminals (**J9**) on right

## Connecting SunTouch® Control System to a Gas Heater

The SunTouch® Control System motherboard provides a set of low voltage dry contacts that can be connected to most gas heaters and heat pumps. Refer to your heater documentation for specific wiring instructions for connecting the heater to an external control (typically using a two-wire remote control connection).

*Note: The SunTouch Control System motherboard heater screw terminals (J12) can be used for high voltage connection not higher than 24 VAC or VDC current for electric heaters or heat pumps.*

### Connecting to a standard heater

The following installation instructions are for gas heaters and heat pumps with low voltage thermostats.

To connect a standard heater to the SunTouch Control System:

1. Switch the power OFF to the heater.
2. Run a two-conductor cable from the heater thermostat area to the low voltage raceway to the motherboard in the SunTouch Control System Power Center. Use 105° C temperature rated wire for connection to the heater. When connecting wires inside the heater, be cautious of HOT internal parts of the heater. Refer to the heater owners manual for the manufacturer's recommendations for the minimum temperature rating for wires.
3. Strip the conductors ¼ in. Insert the wires into the **GAS HEATER** two-screw terminals (**J12**) on the motherboard. For SunTouch Control System motherboard wiring connections, refer to "SunTouch Control System Motherboard Connections," on page 53.
4. At the heater, connect the wires in accordance with heater manufacturer's instructions. For older heaters without instructions for remote operation, connect the wires to the "Fireman's Switch" connections in series with the thermostat, pressure switch, and other safety switches.
5. Do NOT disconnect or wire around the thermostat, pressure switch, high limit switch, or other safety devices.
6. Switch ON the main power switch of the heater. *Note; the SunTouch Control System does not control the AC power to the heater.*
7. Set the heater thermostat to the maximum hottest setting.
8. From the SunTouch Control System menu (see page 26): Goto Main Menu 10/14 "**Circ Functions**" and assign AUX 1 or AUX 2 to "**HEATER.**"

### Connecting to a Pentair Aquatic System MiniMax®, MasterTemp® Gas Heater

To connect a MiniMax or MasterTemp® Heater to the SunTouch Control System Power Center:

1. Switch the power OFF to the heater.
2. Remove the factory installed jumper from the "Ext Switch" connector.
3. Connect the two-wire cable from **J12** on the SunTouch Control System motherboard to the "Ext Switch" terminal. *CAUTION: Be sure that the wires from the heater to the SunTouch Control System Power Center are not near or touching any line voltage wires in the heater. Failure to follow these instructions may cause the heater to malfunction.*
4. Set the Power (Thermostat Select) switch to either "Pool" or "Spa."
5. Set the "Pool" and "Spa" thermostats to their maximum position.
6. From the SunTouch Control System menu (see page 26): Goto Main Menu 10/14 "**Circ Functions**" and assign AUX 1 or AUX 2 to "**HEATER.**"

## Connecting to a Sta-Rite® Gas Heater

To connect a StaRite® Gas Heater to the SunTouch® Control System power center (including Max-E-Therm® Gas Heater):

1. Switch the power OFF to the heater.
2. Remove the upper jacket and open the control box.
3. Remove the jumper for the “Fireman’s switch.”
4. Connect the two-wire cable from **J12** on the SunTouch Control System motherboard to the “Fireman’s Switch” connector block. Use 105° C temperature rated wire for connection to the heater. When connecting wires inside the heater, be cautious of HOT internal parts of the heater. Refer to the minimum temperature rating for wires recommended by the manufacturer. See the heater owners manual for details.
5. Switch ON the main power toggle switch of the heater. Note; the SunTouch Control System does not control the AC power to the heater.
6. Set the heater thermostats to the maximum position.
7. From the SunTouch Control System menu (see page 26): Goto Main Menu 10/14 “**Circ Functions**” and assign AUX 1 or AUX 2 to “**HEATER.**”

## Connecting to a Standard Heat Pump (UltraTemp® Heat Pump) or Electric Heater

To connect a standard heat pump the SunTouch® Control System power center:

1. Switch the power OFF to the heater.
2. Remove the factory installed jumper from the “Ext Switch” connector.
3. Connect the two-wire cable from **J12** on the SunTouch Control System motherboard to the “Ext Switch” terminal. **CAUTION: Be sure that the wires from the heater to the SunTouch Control System Power Center are not near or touching any line voltage wires in the heater. Failure to follow these instructions may cause the heater to malfunction.**
4. Set the Power (Thermostat Select) switch to either “Pool” or “Spa.”
5. Set the “Pool” and “Spa” thermostats to their maximum position.
6. From the SunTouch Control System menu (see page 26): Goto Main Menu 10/14 “**Circ Functions**” and assign AUX 3 Circuit to “**SOLAR**”

## SunTouch® Control System Solar System Installation

- To ensure maximum flow of water through the solar panels, a solar booster pump should be added if panels are installed at a very high elevation.
- It is recommended that the solar panels are mounted in a way that gravity will allow draining whenever the filter pump is not on.
- For systems with glazed panels, damage can occur from overheating if the filter pump is still running after the solar has turned off. To enable glazed panels to automatically drain whenever the solar turns off (even if the filter pump is still running), a 1/2" motorized solar drain valve should be plumbed from the solar feed line, through a check valve, to a zero psi point (such as pool fill line or jet air intake).

## SunTouch® Control System Solar System Start-Up

1. Switch power on to the SunTouch® Control System Power Center.
2. If pool cleaner protection has been added to the system, the pool cleaner pump motor should be activated whenever the pool cleaner timer is on. Momentarily turn pool cleaner on and off to check the motor is operating correctly.
3. Check that Solar Valve is in "solar bypass" position, diverting water away from solar panels. If Solar Valve is staged incorrectly (diverting water to the solar panels), reverse switch on back of Valve Actuator (change from ON1 to ON2, or vice-versa). The Valve Actuator will automatically rotate to the correct position.
4. Check that Solar Valve has rotated from the "solar bypass" position to the "solar" position, diverting water through the solar panels.
5. The system is now ready to be operated as desired.

## Pool Cleaner Protection

Recommended for use in pool systems which utilize a "booster pump" pool cleaner. This feature automatically turns off the pool cleaner pump for a few minutes whenever solar is initiated. This will protect the pump from damage caused by air in the solar panels at system start-up.



## SunTouch® Control System Start-Up

Perform the following start-up procedures to ensure the SunTouch® Control System enclosure is installed correctly.

Before you power up the SunTouch Control System enclosure check the following:

### Check Electronics

Check that the following plugs are seated correctly on the motherboard:

- Relay connectors - **PUMP - AUX1 - AUX2**
- Temperature sensors connectors **WATER, SOLAR, AIR (J9)**
- Transformer wire harness (**J10**) attached to the motherboard.
- Heater control connector **GAS HEATER (J12)** or two-wire screw terminal.

Refer to “Summary System Installation Steps Summary,” on page 37, and “SunTouch Control System Motherboard Connections on page 51.

### SunTouch Control System Test

The following describes how to test the main control panel to activate the heater, valves and pumps. Before testing the system, be sure that all pool and spa equipment has been properly installed and connected to the SunTouch Control System enclosure.

#### Testing Valve Actuators and Filter Pump

Use the following steps to test the valve actuators (CVA24T - P/N 263045) for proper rotation.

To test the valve actuators and pool/spa filter pump:

1. Power up the SunTouch Control System Power center.
2. Press the **MENU** button. Circuit On/Off is displayed. Press the **Right arrow** button access the pool filter pump circuit. Press the **Up or Down arrow** button and select ON. Press the **Left arrow** button to return to the main status screen. POOL and the temperature setting will be displayed as shown below.
3. The pool filter pump should be operating. Water will be removed from the pool and returned to the pool.

**POOL 71°F / 91°F 11:  
51AM HEATER**

#### Testing the auxiliary relays

To verify that AUX 1, AUX 2 and AUX 3 relays outputs are operating correctly:

1. Power up the SunTouch Control System Power center.
2. Press the **MENU** button. Circuit On/Off is displayed. Press the **Right arrow** button access the AUX 1 setting. Press the **Up or Down arrow** button and select ON. Press the **Left arrow** button to return to the main status screen. The auxiliary number will be displayed as shown below.
3. Repeat step 2 to test AUX 2 and AUX 3 relay.

**AIR 71°F  
11: 51AM AUX123**

## Setting up the SunTouch® Control System for the First Time (after equipment installation)

Use the following steps if you are setting up the SunTouch® Control System for the first time. *Note: The following setup steps assume that the SunTouch Control System enclosure is installed at the equipment pad and ready for operation.* The recommended first time installation steps for the SunTouch Control System are:

### 1. Set the system mode and type (page 24)

**System Mode:** Configure the SunTouch Control System to operate in Solar Only or Pool/Spa mode.

**System Type:** Configure the SunTouch Control System to operate as a Shared Equipment system or as a Single Body system (pool only or spa only).

### 2. Set the system date and time: Solar only (page 6). For Pool/Spa mode (page 9)

Set the system time for Solar Only and time and date for Pool/Spa mode.

### 3. Assign a circuit function to a circuit name in Pool/Spa mode (see page 26)

Assign Circuit Functions (menu 10/14) to circuits. From the Circuit Type menu, you can assign special logic to a circuit by selecting one of the available circuit functions. If an auxiliary circuit (AUX) is assigned GENERIC (simple ON/OFF when the button is pushed) then nothing needs to be done.

### 4. Configure valve actuators (controlled by AUX circuit) in Pool/Spa mode (see page 21)

The SunTouch Control System can drive two auxiliary valve actuators for applications such as solar heating and water features. Assign which circuits will activate valves A (intake) and B (return). Auxiliary valve actuators can be controlled by any AUX circuit. Valve C is automatically assigned to solar if Solar is enabled in the “Solar” menu.

### 5. Set up optional equipment, solar, two-speed pump in Pool/Spa mode (see page 29, 30)

Set up additional equipment such as solar, 2-speed pump, and optional equipment if required. Access the Main Menus (1/14) to setup optional equipment such as the IntelliFlo® VS and VF Pump and IntelliChlor® Salt Chlorine Generator (see page 33 and 79). To configure SunTouch Control System for special equipment:

- Is solar heating available? Is solar being used for a heat pump?
- What circuits will turn 2-Speed pumps to High Speed?
- Cool-down cycle for the heater - Lets you set circuits that switch the filter pump to high speed.
- Do you want to delay turning off the filter pump for 10 minutes when the heater is turned off?
- Do you want the spa to heat whenever the Spa button is pressed?

**CAUTION: When using the IntelliChlor Salt Chlorine Generator and the IntelliFlo Pump with the SunTouch Control System, the IntelliChlor Salt Chlorine Generator Power Center AC power wires must be connected to the PUMP SIDE OF THE RELAY located in the SunTouch Control System Power Center. This ensures that IntelliChlor Salt Chlorine Generator produces chlorine only when the main filter pump is on. See page 79 for details.**

### 6. Configuring the heater system options Pool/Spa mode (page 14)

Set the type of heat source being used (Heater, Solar, Solar Preferred).

### 7. Configure the QuickTouch® Wireless Remote buttons (page 28)

Assign four circuits to the QuickTouch remote buttons. Once you have checked that all buttons operate properly, place labels on remote buttons.

### 8. Schedule on/off times for circuit (page 17)

Set times for automatic circuit activation. Up to 6 total programs can be created for all circuits combined. One circuit can have up to a maximum of 4 programs (4/4). All user created programs are active all the time; so check that there are not conflicting automated times.

## Connecting IntelliChem® Controller to the SunTouch® Control System

To connect IntelliChem® Controller COM Port Cable to the SunTouch® Control System COM port:

IntelliChem® Controller is connected to the SunTouch® Control System via the RS-485 cable. The RS-485 communication cable is connected to the COM port on the SunTouch Control System circuit board. For more information, refer to the IntelliChem Controller Installation and User's Guide (P/N 521363)

1. **Connect IntelliChem Controller cable to COM Port (J7):** Strip back the cable conductors ¼ in. Insert the wires into the connector screw terminals. Make sure to match the color coding of the wires; YELLOW = +DATA, GREEN = -DATA and BLACK = GND. Secure the wires with the screws.
2. Run an RS-485 cable from the IntelliChem enclosure to the SunTouch Control System enclosure.
3. **WARNING! Switch AC power OFF to the SunTouch Control System Power Center :**  
Open the SunTouch Control System front door.  
Route the cable from IntelliChem Controller up through the lower grommet opening into the SunTouch enclosure.
4. Strip back the IntelliChem Controller cable conductors ¼ in. Insert the wires into the SunTouch Control System COM port connector screw terminals on the circuit board (**J11**). Make sure to match the color coding of the wires; YELLOW = +DATA, GREEN = -DATA and BLACK = GND. Secure the wires with the screws.
5. Close the front control panel and secure with the retaining screw.
6. Close the Power Center front door. Fasten the spring latch.

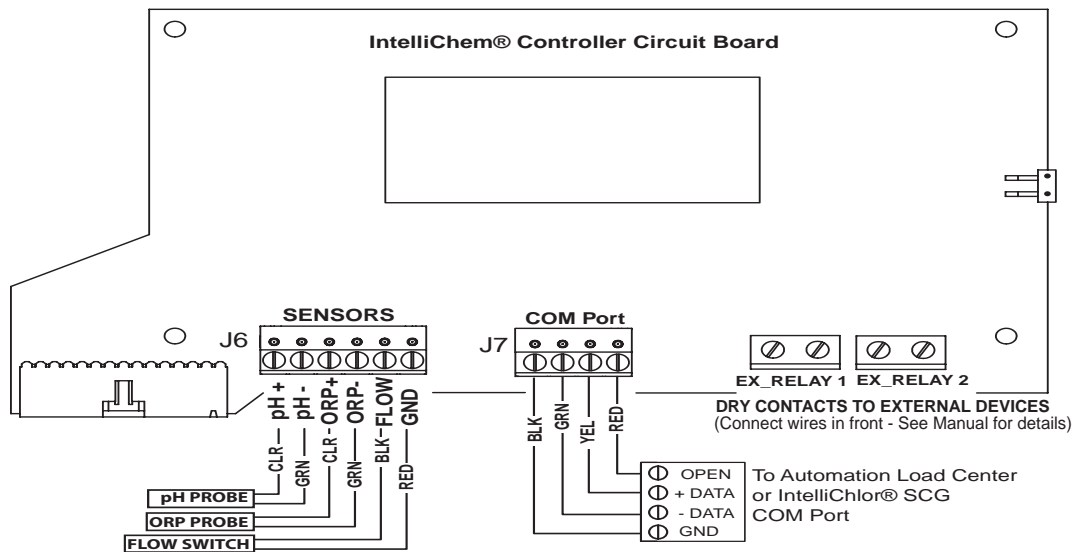

IntelliChem® Controller J7 COM Port Wiring Connections

### View IntelliChem® Controller Status

To access the IntelliChem Controller screens Press **MENU > DIAGNOSTICS > INTELLICHEM**

IntelliChem  
pH: 7.65 ORP:832

Displays the current pH and ORP levels.

## Troubleshooting

Use the following troubleshooting information to help resolve problems that may occur when using the SunTouch® Control System. If by following the recommended actions you are still unable to resolve the problems, please contact Technical Support (see page vi).

### Frequently Asked Questions (FAQ)

#### How do I setup a two-speed pump?

A two-speed pump operates using two relays and one or more circuits. The first relay turns the pump on or off. Assuming this is a filter pump, this circuit is controlled by the pool and spa circuits or any other circuit that may be tied to the filter pump (such as circuits with freeze protection, etc.). The second relay (AUX 2) switches the pump from low speed to high speed. The default condition is low speed. Up to three circuits may be assigned to trigger the pump to high speed. However, if three relays are being used, two relays must be located outside the SunTouch Control System enclosure. The SunTouch Control System enclosure which houses two relays. Note: These circuits do not switch the pump on.

To configure a two-speed pump relay, refer to “Settings Menu: 2-Speed Pump,” on page 29. For relay location and wiring (see page 53). The 2-Speed pump relay connector is plugged into the AUX 3 output socket on the SunTouch Control System motherboard.

#### Can I switch the heater on and change the temperature from the spa?

The heater may be switched on from the spa location using the QuickTouch® Wireless Remote (optional), see page 28 for setup details.

#### How do I switch on solar heating?

The system must first be configured for solar heating. Go to the “Heat” menu (see page 14) and enable “Solar” as the heat source. *Note: Do not select “Heat Pump” as the solar heating method.*

## SunTouch® Control System Error Messages

### Error Messages

If the system detects that a sensor is not connected to the SunTouch® Control System Power Center or it is defective, an error message is displayed in the Diagnostics menu (page 25). The following lists the sensor errors.

Error Message	Possible Cause	Solution
Air Err (Displays on the Main Screen)	Air sensor not connected to the SunTouch motherboard.	Check that the air sensor plug is connected to J21 connector on the motherboard. Check that the sensor wire is connected properly.
Air Temperature Err (Displays in the "Diagnostics" menu)	Air sensor not connected to the SunTouch motherboard.	Check that the air sensor plug is connected to J21 connector on the motherboard.

### Self Test Error Codes

The "Self Test" feature is intended for use by service personnel. If after performing a control panel self test (see Diagnostics menu page 25) there were no errors detected, Code 0 is displayed, indicating that there were no problems and the test was successful. If a problem is detected during the test, an error code is displayed upon completion of the test. For example Code 1 would indicate a problem with the display. If multiple errors are detected, multiple code numbers are displayed. For example, Codes 4, 2, 1, would indicate problems detected with the buttons, LCD contrast, LCD backlight on the control panel.

The following lists the control panel self test error codes.

#### Error Code Table

Error Code	Description
Code 0	PASS - The control panel has no problems
Code 1	LCD backlight

### Resetting the System Fuses

The SunTouch Control System Power Center provides two resettable fuses to protect the 18 VAC and 24 VAC circuits. The fuses are located on the front panel of the SunTouch Control System Power Center. Press the fuse button to reset the fuse. See page 40 for fuse locations.

## Problem Solving a Solar System

SunTouch® Control System solar is not operating

Verify the circuit breaker at sub-panel is not tripped. If the 3 AMP Circuit Breaker on the on the SunTouch® Control System is tripped, it is most often due to a defective Circuit Board or Valve Actuator. Try disconnecting each one separately to determine which one is at fault.

Solar will only operate when the solar temperature is 6° warmer than the water temperature.

Inspect the appropriate sensor cable and wire connections and replace the appropriate temperature sensor if necessary. An ohm meter can be used to take a reading of the sensors. See table on page 68.

If the temperature sensors are not at fault, replace the SunTouch Control System circuit board.

### Water flow to panels switch does not operate the valve actuator

If the valve actuator does not operate when using the WATER FLOW TO PANELS Switch (sliding switch between ON and OFF), either the valve actuator or the SunTouch circuit board is at fault.

First verify that the toggle switch located on the valve actuator is either in the ON1 or ON2 position.

With a voltmeter, check the output voltage of the VLV1 socket located on the SunTouch Control System circuit board. When the WATER FLOW TO PANELS Switch is in the OFF position, the top and middle pins should read 24 VAC. When the WATER FLOW TO PANELS switch is in the ON position, the top and bottom pins should read 24 VAC.

If voltage readings are correct, replace the valve actuator. If voltage readings are incorrect, replace the SunTouch Control System circuit board.

### Checking The Temperature Sensors

Disconnect temperature Sensor wires from the SunTouch Control System circuit board, and test sensor using an ohm meter. See table on page 66.

## Testing the Solar System

To test the SunTouch Control System in “SOLAR ONLY” mode: Set the “System Control” menu setting to “SOLAR ON” verify the valve(s) are in the solar position. Then set the menu setting to “SOLAR OFF” and verify the valve is in the normal recirculating pool position. If the valve(s) positions are working in reverse, toggle the valve switches and test again.

## Air Sensor ERROR

If after enabling the optional air sensor (see page 24) the main screen displays **AIR Error** or **Solar Sensor ERR**, this indicates the solar sensor is not connected or it is out of range. Check that the sensor is connected correctly to connector J9 on the SunTouch Control System motherboard (see page 53).

## Temperature vs. Resistance Data

The SunTouch® Control System use 10k Ohm thermistor sensors. When the solar sensor is disconnected from the SunTouch Control System, the sensor will read 10k Ohm at 77° F (25°C). Refer to the following table for the resistance at other temperatures. An accurate reading should give a temperature setting that is accurate

Temperature		Resistance	Temperature		Resistance
°C	°F	Ohm	°C	°F	Ohm
-26	-15	139,300	16	60	15,310
-25	-13	130,300	18	65	13,480
-23	-10	118,000	21	70	11,880
-21	-5	100,200	24	75	10,500
-20	-4	97,000 25	25	77	10,000
-18	0	85,350 27	27	80	9,298
-15	5	72,910 29	29	85	8,250
-12	10	62,480 30	30	86	8,056
-9	15	53,640 32	32	90	7,331
-10	14	55,300 35	35	95	6,530
-7	20	46,230 38	38	100	5,826
-5	23	42,300 40	40	104	5,326
-4	25	39,910 41	41	105	5,209
-1	30	34,560 43	43	110	4,663
0	32	32,600 45	45	113	4,367
2	35	30,000 49	49	120	3,757
4.7	40	26,100 50	50	122	3,602
5	41	25,400 52	52	125	3,381
7	45	22,760 54	54	130	3,047
10	50	19,900 55	55	131	2,985
13	55	17,440 57	57	135	2,750
15	59	15,700			

## IntelliChlor® Salt Chlorine Generator Error Messages

IntelliChlor® Salt Chlorine Generator (SCG) status and error messages are displayed in the “Chlorinator” menu (see page 32). Use the following information to resolve IntelliChlor Salt Chlorine Generator system problems. To access the IntelliChlor Salt Chlorine Generator menu, press **Menu > Diagnostics > Chlorinator**.

Status Message	Possible Cause	Solution
OK-NO ERRORS	IntelliChlor (SCG) normal operating mode.	N/A
SUPER CHLORINATE	IntelliChlor (SCG) is in “Super Chlorination” mode for 24 hours.	IntelliChlor is in “Super Chlorination mode (see page 32 for details)
COM LINK ERROR	IntelliChlor (SCG) communication error with SunTouch Control System motherboard.	Check cable from IntelliChlor (SCG) to SunTouch Control System motherboard.
CHECK FLOW/PCB	Check IntelliChlor (SCG) electrolytic cell.	Refer to IntelliChlor (SCG) User’s Guide troubleshooting information.
LOW SALT	Add salt to pool water.	The water salt level is between 2500 ppm and 2900 ppm. The IntelliChlor (SCG) will continue to produce chlorine at a reduced level. See IntelliChlor (SCG) User’s Guide for details.

## System Problem Diagnosis

Use the following information to resolve system problems.

**Problem:** SunTouch Control System LCD fails to operate.

Symptom	Possible Cause	Solution
SunTouch Control System enclosure has no power - (screen, blank, no LEDs, buttons not working).	Bad wiring run from Outdoor Control Panel/ motherboard in the Load Center.	Verify cable and ensure no connections are broken. In some cases a wire is broken under the insulation. The two center wires of the four conductor cable are suspect (Green and Yellow)
SunTouch Control System control panel LCD lights up, but fails to operate correctly.	Defective Cable/wiring	Verify cable and ensure no connections are broken. In some cases a wire is broken under the insulation. The two center wires of the four conductor cable are suspect (Green and Yellow)



**Problem:** The QuickTouch® Wireless Remote will not work, or will not work dependably.

Symptom	Possible Cause	Solution
POWER LED does not light on the Receiver board located in the plastic clam shell.	SunTouch Control System Load Center does not have power	Ensure power is being supplied and that the power center operates correctly without the receiver installed
	Defective cable or connection to the Load Center	Verify the function of the board using known good cable set. Check all wiring
	Defective Receiver board	Contact Technical Support
COMM LINK LED does not light or blink. In normal operation LED will blink at least every 2 seconds	Defective cable or connection to the Load Center	Verify the function of the board using known good cable set
	Defective receiver board	Replace receiver board
Address switches are incorrectly configured	Verify that the address switches on the transmitter and handheld receiver board are correct and match	Transmitter battery has failed
	Replace Transmitter battery	Defective Transmitter or Receiver

Symptom	Possible Cause	Solution
Unit seems to turn on or off circuits without the user / transmitter	A near by home is operating a similar wireless unit	Select an alternate address code for the transmitter and receiver. Change the DIP switches on both Transceiver and remote to an alternate, but matching setting.

## IntelliFlo® VS and IntelliFlo VF Warning and Alarm Conditions

The IntelliFlo® VS and VF Pump alarms and warnings are indicated by flashing LEDs on the control panel. For example, if a “Drive Temperature” warning occurs, the LED will blink two times, then Off, then blink two times. This sequence is repeated until the condition is cleared.

- **Warning condition:** If a warning condition occurs the pump will continue to run but at a reduced speed. The Green LED executes a sequence of blinks to indicate which alarm or warning has occurred.
- **Alarm condition:** If an alarm condition occurs the pump will stop running. The red LED flashes continuously to indicate the presence of an alarm. The alarm LEDs will reset when the condition clears.

See “Pump” Main Menu (12/14) on page 29 for setup information. For IntelliFlo Pump troubleshooting information, see the IntelliFlo VS Pump Installation and User’s Guide (P/N 357269) and IntelliFlo VF Installation and User’s Guide (P/N 350075).

Number of time the LED will blink	Alarm	Description	Action
2	Drive Temperature Warning	Excessive drive temperature	<ol style="list-style-type: none"> <li>1. Ensure the motor fan has adequate area for ventilation.</li> <li>2. Stop motor and allow to cool.</li> <li>3. Run motor at a higher speed to improve cooling air flow.</li> </ol>
5	Unknown alarm	Electron failure	<ol style="list-style-type: none"> <li>1. Cycle power to reset pump.</li> <li>2. Replace drive.</li> </ol>
6	Drive Temperature Alarm	Excessive drive temperature	<ol style="list-style-type: none"> <li>1. Ensure the motor fan has adequate area for ventilation.</li> <li>2. Run motor at a higher speed to improve cooling air flow.</li> </ol>
7	Power Out Alarm	Supply voltage low	Ensure proper supply voltage.

## SunTouch® Control System Specifications

- Power: 95 VAC to 135 VAC, 0.82 AMP 50/60 Hz or 192 VAC to 288 VAC, 0.41 AMP 50/60Hz
- Valve Actuator Output: 24VAC, 50/60 Hz. 0.65 AMP maximum (3 pin connector)
- Relay Outputs: 3HP@240V, 1.5HP@120V, booster pump, pool sweep interlock, filter pump or lights. Three (3) relays provided.
- Sensors (thermistor type, 10K W 77° F (25° C). Two sensors required for solar and pool temperatures. Freeze protection requires an additional sensor for air temperature.
- Start Temperature Differential (Solar): 3° - 9°
- Stop Temperature Differential (Solar): 2° - 5°
- Set Temperature limit: 40° F to 104° F (4° C to 40° C) calibrated scale
- Freeze Protection: On at 35° F, off at 38° F

## Wiring SunTouch® Control System to the IntelliChlor® Salt Chlorine Generator

Be sure to check the wire color and function of the IntelliChlor® Salt Chlorine Generator (SCG) before connecting it to the SunTouch® Control System COM port on the motherboard. See the wiring table below for the pin configuration.

Failure to wire the salt chlorine generator properly can permanently damage the SunTouch Control System or chlorine generator. For more information about wiring IntelliChlor (SCG) to the SunTouch Control System Power Center, see page 79. See “IntelliChlor” Main Menu (13/14) on page 33 for setup information.

**IntelliChlor (SCG) AC Wiring Instructions:** When using an IntelliChlor (SCG) with the SunTouch Control System, the IntelliChlor (SCG) AC power center wires must be connected to the PUMP SIDE OF THE MAIN FILTER PUMP RELAY (LOAD SIDE) located in the SunTouch Control System Power Center. This ensures the IntelliChlor cell produces chlorine only when the main filter pump is on (see page 73 and 74).

### Wiring Description (SunTouch Control System COM Port to IntelliChlor (SCG) Power Center COM Port)

SunTouch Control System COM Port wiring color connection	Description	IntelliChlor (SCG) Power Center COM Port
RED	+15 VDC	RED
YELLOW	+ DATA	YELLOW

### Wiring Description (Hayward® or Jandy® Control System Load Center COM Port)

Hayward® or Jandy® Control System Load Center COM port wiring color connection	Description	IntelliChlor Salt Chlorine Generator
RED	+15 VDC	RED
YELLOW	+ DATA	BLACK
GREEN	- DATA	YELLOW

## Wiring IntelliChlor® (SCG) and Standard Pump to SunTouch® Control System

The following diagram shows how to connect the IntelliChlor® (SCG), a standard pool filter pump to the SunTouch® Control System Power Center.

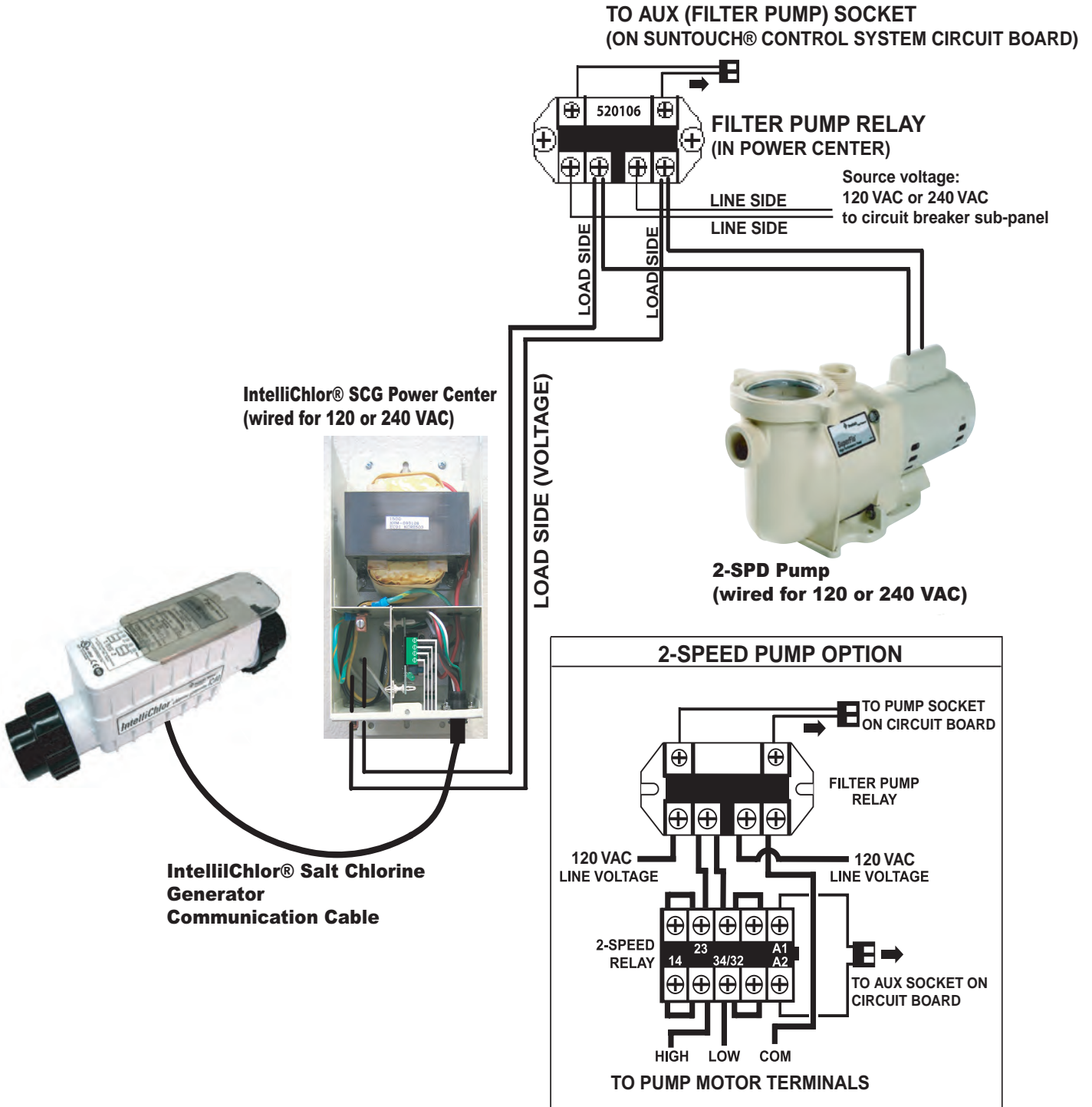

## Wiring IntelliChlor® (SCG) and IntelliFlo® Pump to SunTouch® Control System

The following diagram shows how to connect the IntelliChlor® (SCG), an IntelliFlo® Pool Filter Pump to the SunTouch® Control System Power Center.

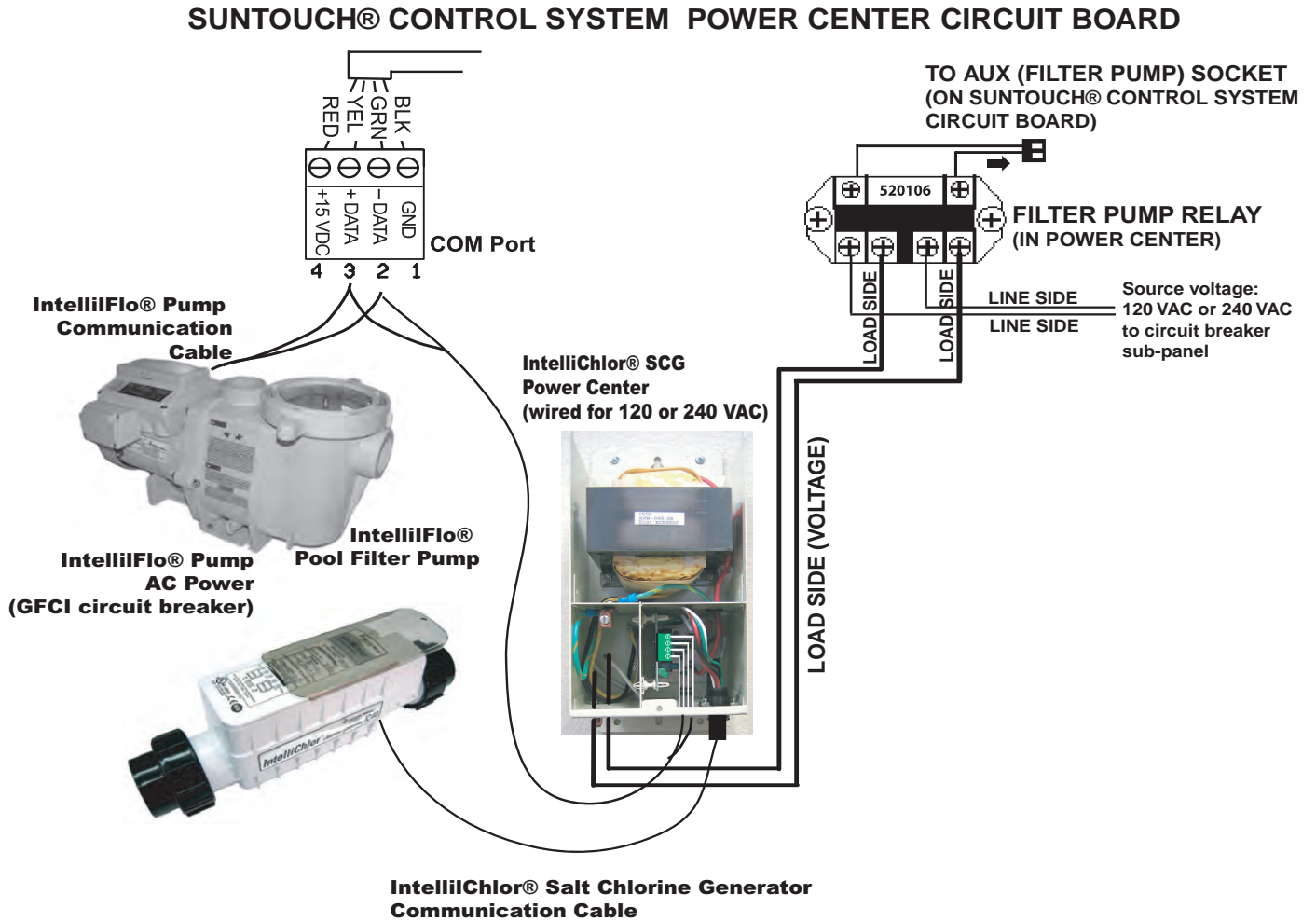

## Appendix

# Emergency Shut-Off Switch (ESO3)

### Emergency Shut-Off switch

The SunTouch® Control System can be used for commercial spa applications that require an Emergency Shut-Off (ESO3) switch. It can be installed with new or existing pool and spa system. In the event of an emergency, the spa can be shut off by pushing the red emergency button. This action interrupts power to the filter pump, jet pump, an optional auxiliary pump, air blower, or equipment connected to AUX 1, or AUX 2. Pulling the emergency button back out will return the pumps to normal operation, and shut off the alarm.

### Location

Select a convenient location to mount the Emergency Shut-Off switch. Provide a double-gang electrical box. The electrical box must be rated for outdoor use if the Emergency Shut-Off is located outside. Provide and install a standard spring-wound timer for the jet pump and filter pump. Install cable, using plastic or metallic conduit where cables run underground.

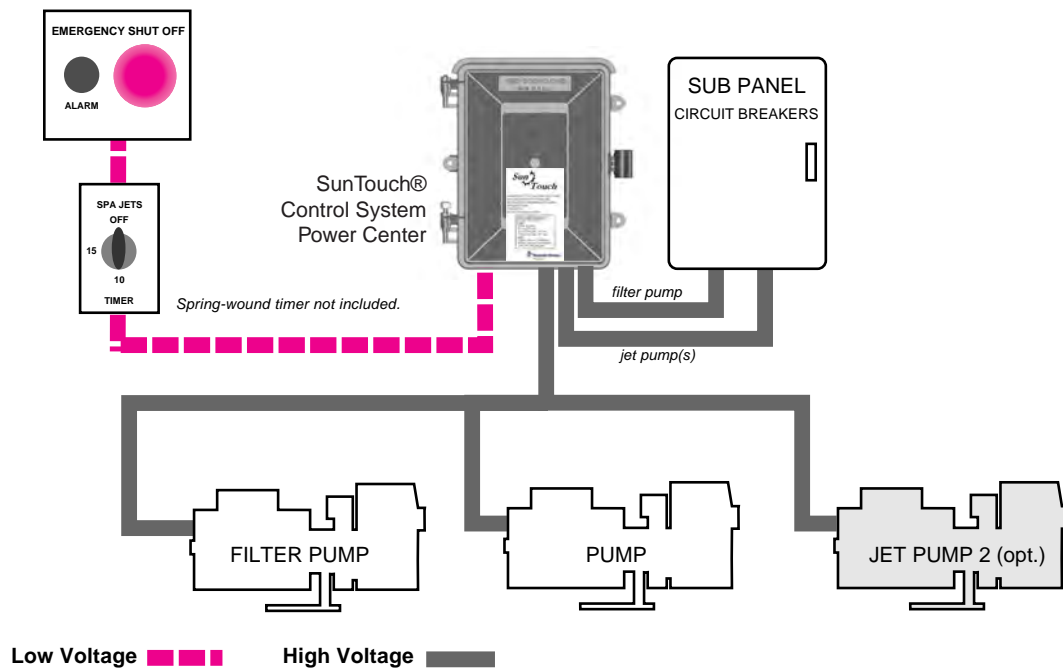

### Commercial Application

See “Commercial Application using ESO3 and SunTouch Control System (Single Body System) on page 36 for information.

## Installing the ESO Circuit Board

To access the SunTouch® Control System Power Center electronics compartment:

**Safety Notice: Important Safety Instructions** - When installing and using this electrical equipment, basic safety precautions should always be followed. Before installing the Emergency Shut-Off Switch, read all safety information on page i through iv.

1. Switch the main power OFF to the SunTouch® Control System Power Center.
2. Unlatch the front door,
3. Loosen the retaining screw on the front panel. Open the hinged front panel to access the electronics compartment.
4. Mount the Emergency Shut-off Switch circuit board on the two mounting studs. Secure the circuit board with the two retaining screws.

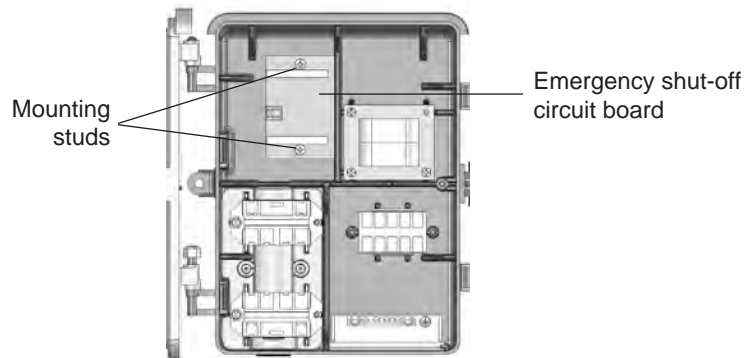

SunTouch® Control System Power

5. **Connecting relay plugs:** Connect the relay cable plugs to the two-pin sockets on the right-side of the Emergency Shut-Off Switch circuit board. Connect the corresponding relay cable plugs from the SunTouch motherboard to the left-side of the Emergency Shut-Off Switch circuit board as shown below. For SunTouch Control System motherboard connections, see page 53.

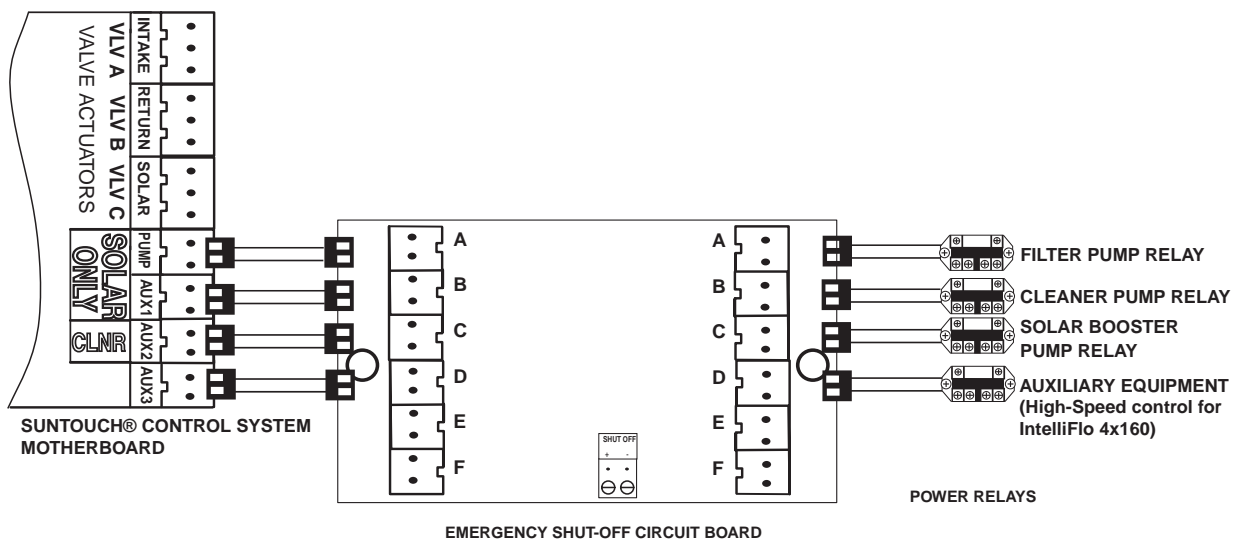

## Installing the ESO Circuit Board (Continued)

6. **Connecting the ESO switch:** Route a two-wire cable through grommet located on the left-side of the SunTouch® Control System Power Center, up into the low voltage raceway to the ESO switch circuit board.
7. Connect the two wires to J13 on the ESO switch circuit board. Connect the other end of the cable to the emergency switch as shown below.
8. Verify that all cable connections are connected correctly. Close the front panel and secure it with the retaining screw. The Emergency Shut-Off Switch installation is complete.

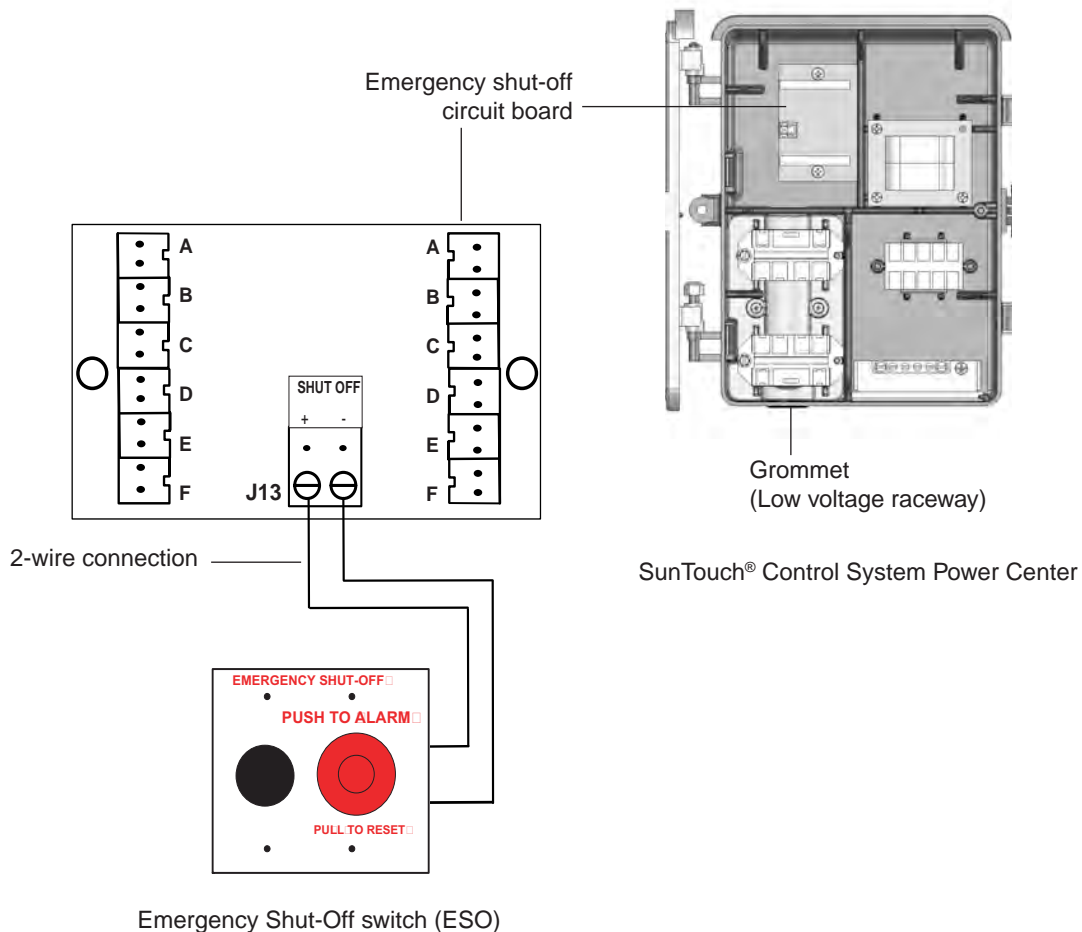



# Commercial Application using ESO3 and SunTouch® Control System (Single Body System)

Using a Emergency Shut-Off Switch (ESO3), circuit board, and a spring wound timer switch (Intermatic® Transformer equivalent), a SunTouch® Control System single body system (P/N 520859) can be configured for a commercial application. A typical configuration, using a single speed pump is shown in the “Commercial Application Connection Diagram” below. As shown, the commercial spa jet pump is controlled by the spring wound timer switch and AUX 1 (Jet pump) is programmed by SunTouch to operate from 5:00 AM to 12:00 AM. When the Emergency Shut-Off Switch is pressed, both relays will disengage. If the pool or spa light is controlled by AUX 2, the light will remain operational.

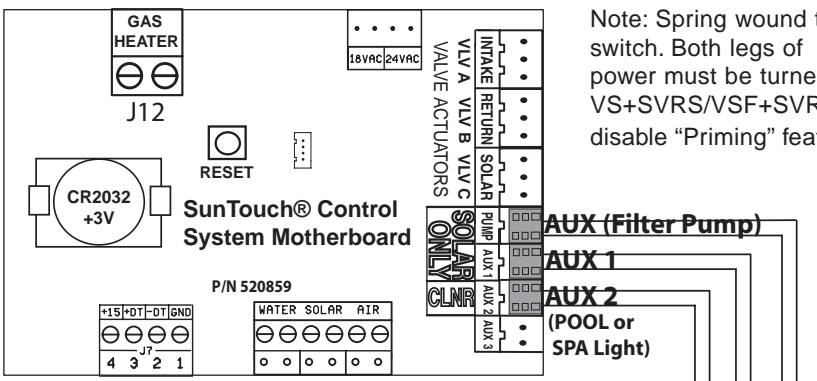

Note: Spring wound timer must be a DPST switch. Both legs of power must be turned OFF. For IntelliFlo® VS+SVRS/VSF+SVRS Pump, disable “Priming” feature.

- Required Parts:**
1. P/N 520859 SunTouch Control System Single Body
  2. P/N ES03 Emergency Shut Off
  3. Spring Timer (P/N FF4 15M, FF4 30M, FF4 60M)
- Note: Spring wound timer (DPS) for booster jet pump must be rated for proper amperage.

**SunTouch® Control System for commercial application with IntelliFlo VS+SVRS and IntelliFlo® VSF+SVRS Pump**

IntelliFlo VS+SVRS and VSF+SVRS Filter Pump is controller by SunTouch Control System Internal time clock AUX 1 (VS+SVRS Jet Pump) in this applicatin will be programmed to operate during the hours of operation (e.g. 5:00 AM - 12:00 AM). When Emergency Switch is pressed, both relays disengaged. If the pool or spa light are controlled by AUX 2 light will remain on. For use with single speed pumps or IntelliFlo VS+SVRS pump.

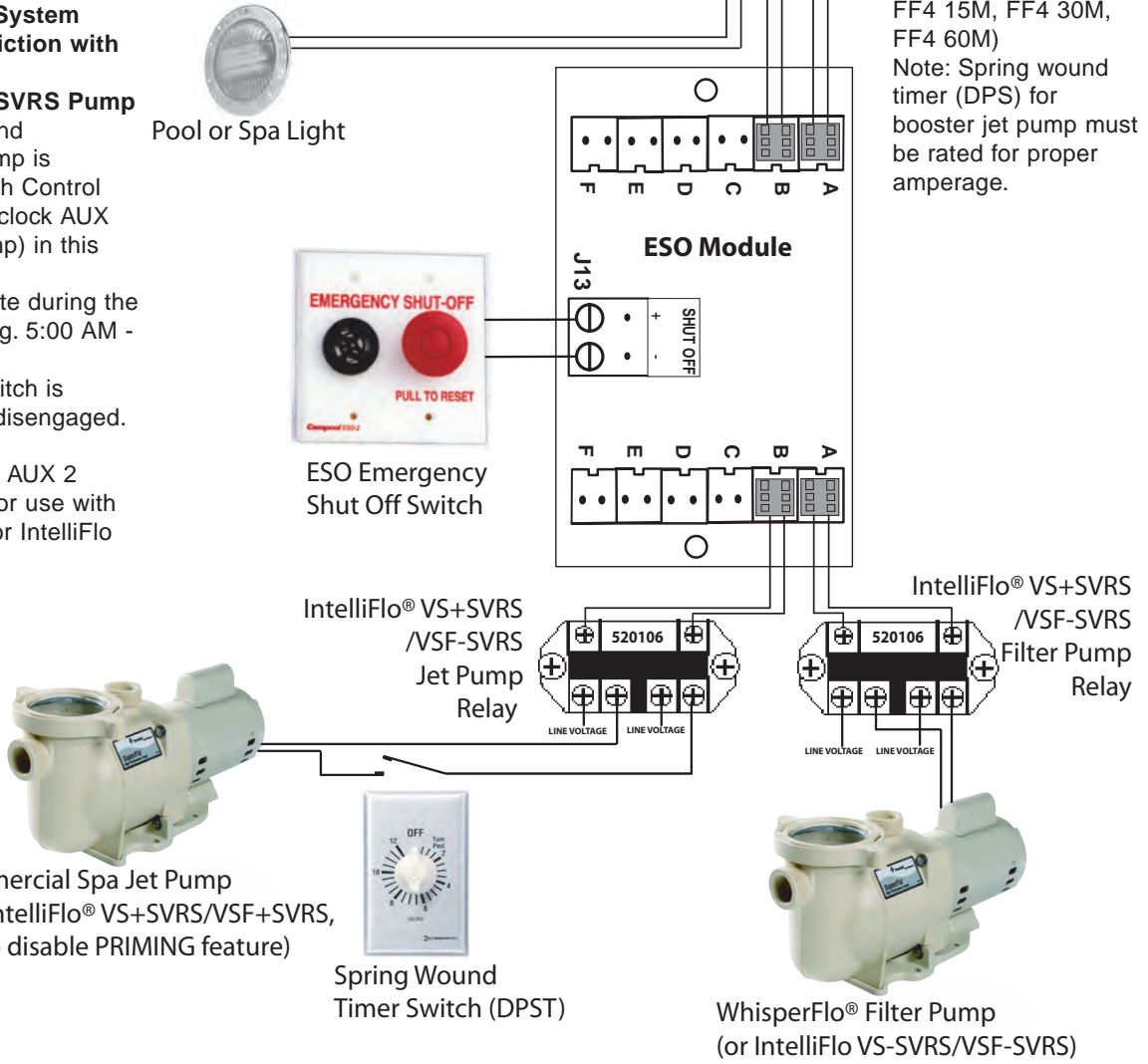

## Glossary

**Control Panel:** The five button controller with LCD (liquid crystal display) is connected to the SunTouch® Control System motherboard located in the Power Center.

**High Voltage Compartment:** The high voltage compartment in the SunTouch Control System Power Center for the transformer.

**IntelliChlor® Salt Chlorine Generator (SCG):** Electronic salt chlorinator. Uses a process known as electrolysis to produce sodium hypochlorite (liquid chlorine) from a low concentration of salt added to the pool/spa water. See IntelliChlor (SCG) menu features on page 33. The IntelliChlor (SCG) models are:

- IC15 Cell (P/N 520888): Designed for pools up to 15,000 U.S. gallons (56,000 cubic meters). The cell will produce the equivalent of 0.60 pounds of pure chlorine per 24 hours of continuous pool pump runtime.
- IC20 Cell (P/N 520554): Designed for pools up to 20,000 U.S. gallons (75,000 liters). The cell will produce the equivalent of 0.70 lbs. of pure chlorine per 24 hours of continuous pool pump run time.
- IC40 Cell (P/N 520555): Designed for pools up to 40,000 U.S. gallons (150,000 liters). The cell will produce the equivalent of 1.40 lbs. of pure chlorine per 24 hours of continuous pool pump run time.
- IC60 Cell (P/N 521105): Designed for pools up to 60,000 U.S. gallons (227,124 liters). The cell will produce the equivalent of 2 lbs. of pure chlorine per 24 hours of continuous pool pump run time.

**Low Voltage Compartment:** Top compartment of SunTouch Control System Power Center for low voltage wiring.

**Low Voltage Raceway:** Vertical space in the left side of SunTouch Control System Power Center for low voltage wires.

**Motherboard:** The SunTouch Control System circuit board mounted behind the control panel.

**Power Center:** Plastic enclosure for housing the SunTouch Control System power relays, transformer, and circuit breakers. Used for distributing power for controlling the SunTouch Control System.

**Relay:** A low-powered device used to activate a high-powered device. SunTouch Control System relays are used to activate equipment such as pumps, and lights. Relays connect to the SunTouch Control System motherboard. A maximum of three relays can be installed the SunTouch Control System motherboard.

**Screw Terminal Connector:** Removable connector that may attach to SunTouch Control System motherboard circuit board with multiple sockets (anywhere from 2 to 6) to receive wires from controllers and sensors; wires held by screw terminals; multiple wires of a small enough gauge (usually 22 AWG) may be coupled to a single socket of a terminal connector.

**Salt Chlorine Generator (SCG):** Automated pool chlorinator that sanitizes using salt water (see IntelliChlor (SCG) menu features on page 33).

**Solar Pool Heater:** Solar pool/spa systems are low cost, simple and relatively inexpensive. Pool water pumped through unglazed plastic panels (collectors) produces water heated by the sun. The pool itself is the thermal storage for the system, and the pool filter pump circulates water through the solar collectors. SunTouch Control System supports differential temperature control which also includes solar nocturnal cooling control for optimizing heat control at night (see page 4 and 19).

**Transceiver:** Used by the QuickTouch® Wireless Remote. Circuit board with attached antenna that sends radio frequency (wireless) transmissions.

Notes



1620 HAWKINS AVE., SANFORD, NC 27330 • (919) 566-8000  
10951 WEST LOS ANGELES AVE., MOORPARK, CA 93021 • (805) 553-5000

[www.pentairpool.com](http://www.pentairpool.com)

All Pentair trademarks and logos are owned by Pentair Inc. Pentair Aquatic Systems™, and SunTouch®, IntelliTouch®, QuickTouch®, IntelliChlor®, IntelliFlo®, IntelliChem®, Sta-Rite®, MiniMax®, MasterTemp®, WhisperFlo® and UltraTemp® are trademarks and/or registered trademarks of Pentair Water Pool and Spa, Inc. and/or its affiliated companies in the United States and/or other countries. Hayward® is a registered trademark of Hayward Industries Inc. Jandy® is a registered trademark of Jandy Industries Inc. Unless expressly noted, names and brands of third parties that may be used in this document are not used to indicate an affiliation or endorsement between the owners of these names and brands and Pentair Water Pool and Spa, Inc. Those names and brands may be the trademarks or registered trademarks of those third parties. Because we are continuously improving our products and services, Pentair reserves the right to change specifications without prior notice. Pentair is an equal opportunity employer.

© 2013 Pentair Aquatic Systems Inc.. All rights reserved. This document is subject to change without notice.



P/N 520785 REV. D 8/13