

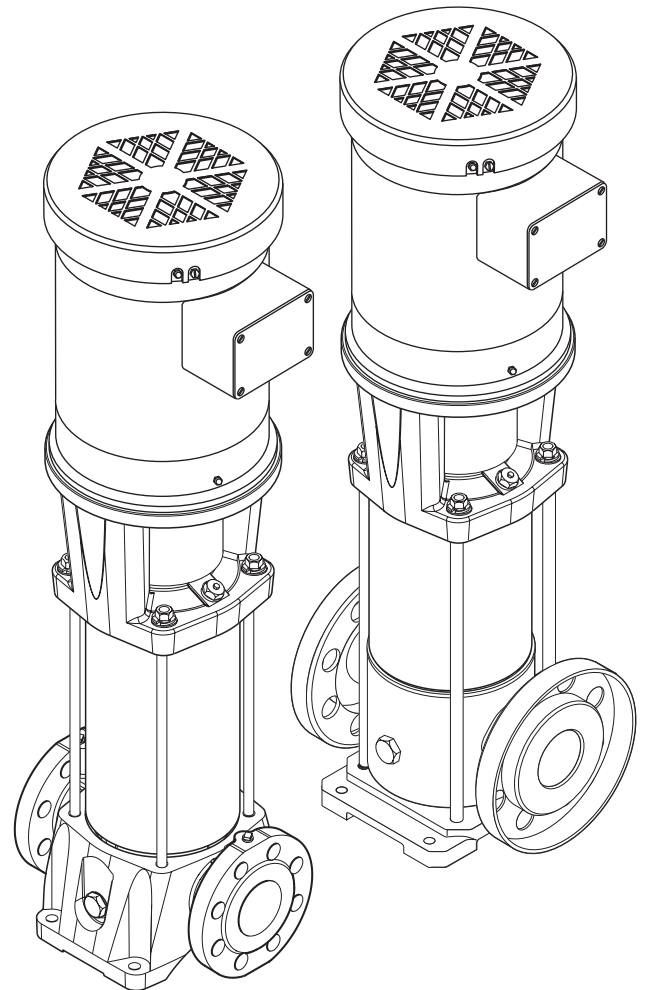

DISCONTINUED - MANUAL FOR REFERENCE ONLY

AURORA[®]

Table of Contents	Page
PVM(X) 2 Series	2-8
PVM(X) 4 Series	9-15
PVM(X) 2 / PVM(X) 4 Construction Materials	16
PVM(X) 8 Series	17-23
PVM(X) 16 Series	24-28
PVM(X) 8 / PVM(X) 16 Construction Materials	29
PVM32 Series	30-33
PVM32 Construction Materials	34
Bypass Orifice Sizing and Vertical Multistage Performance	35



PVM – CAST IRON

PVMX – 316 STAINLESS STEEL

VERTICAL MULTISTAGE PUMPS – 50 HERTZ

CATALOG

NOTE! Read and understand the pump and motor instructions before attempting to install, disassemble or repair the pump.

AURORA PVM(X)2 SERIES

PERFORMANCE CURVES

NOMINAL RPM: 2875 BASED ON FRESH WATER @ 68° F (20° C) MAXIMUM WORKING PRESSURE: 360 PSI (25 BAR)

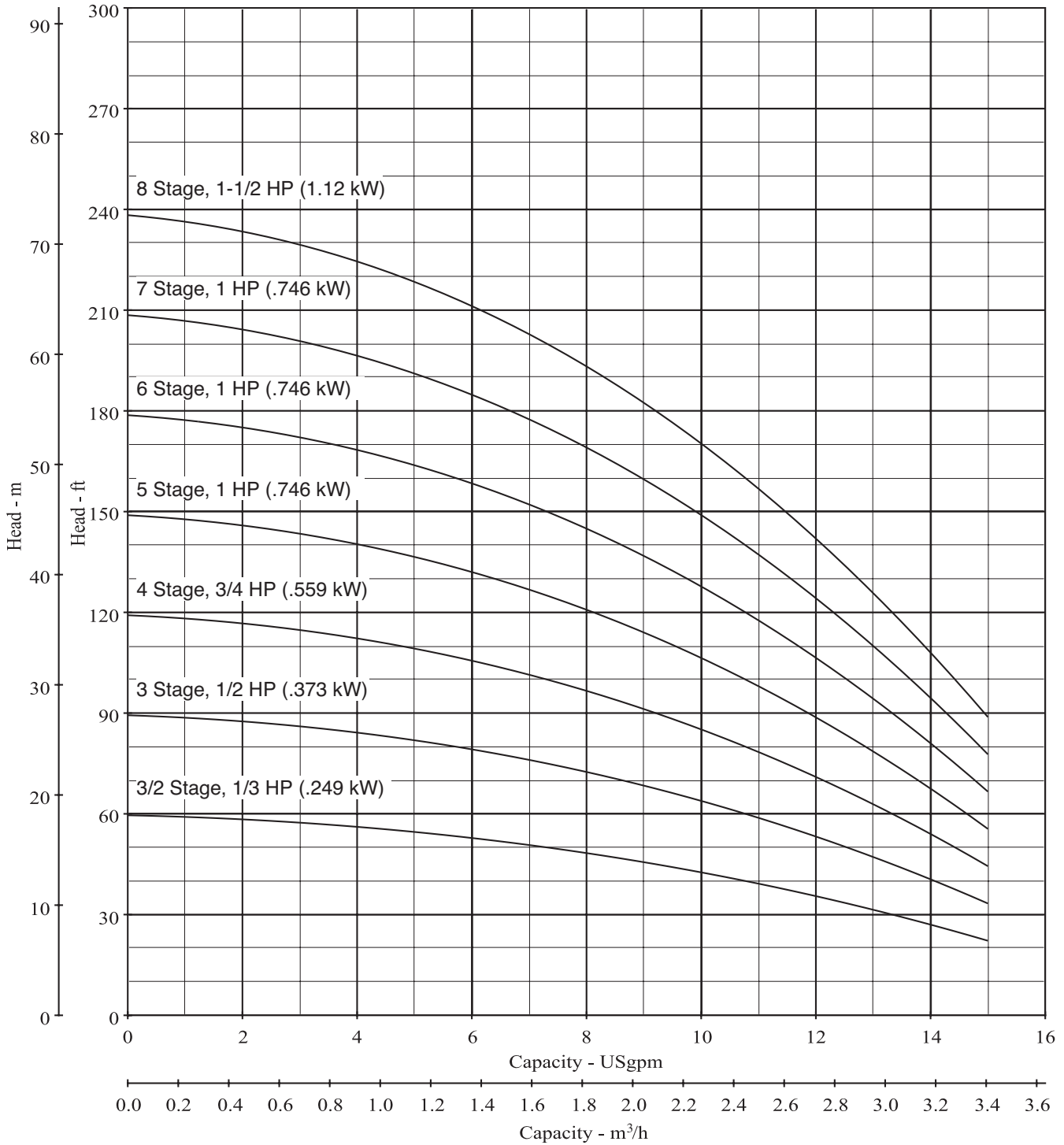

PERFORMANCE CURVES

NOMINAL RPM: 2875

BASED ON FRESH WATER @ 68° F (20° C)

MAXIMUM WORKING PRESSURE: 360 PSI (25 BAR)

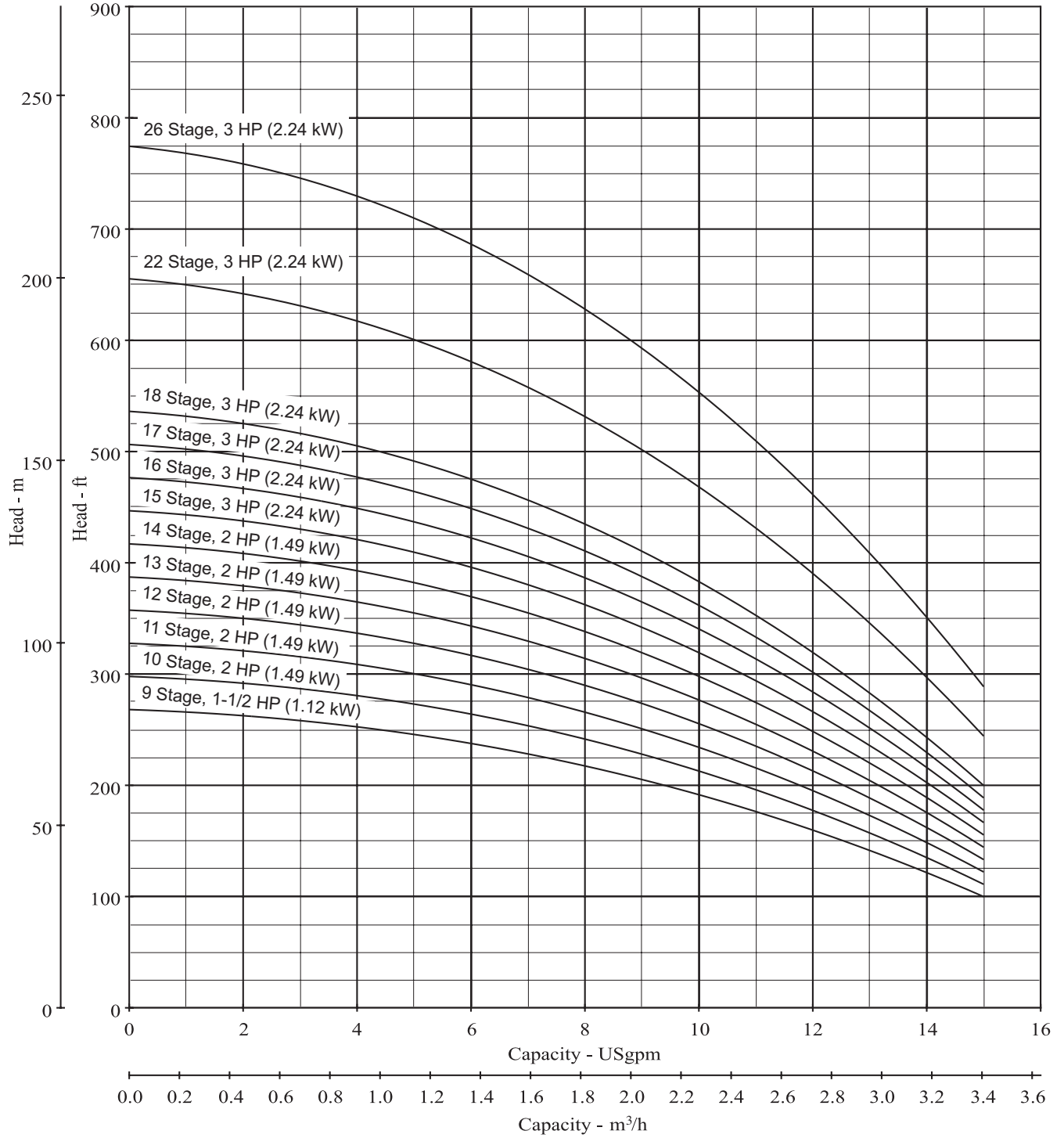

AURORA PVM(X)2 SERIES

SINGLE STAGE PERFORMANCE DATA

NOMINAL RPM: 2875

BASED ON FRESH WATER @ 68° F (20° C)

MAXIMUM WORKING PRESSURE: 360 PSI (25 BAR)

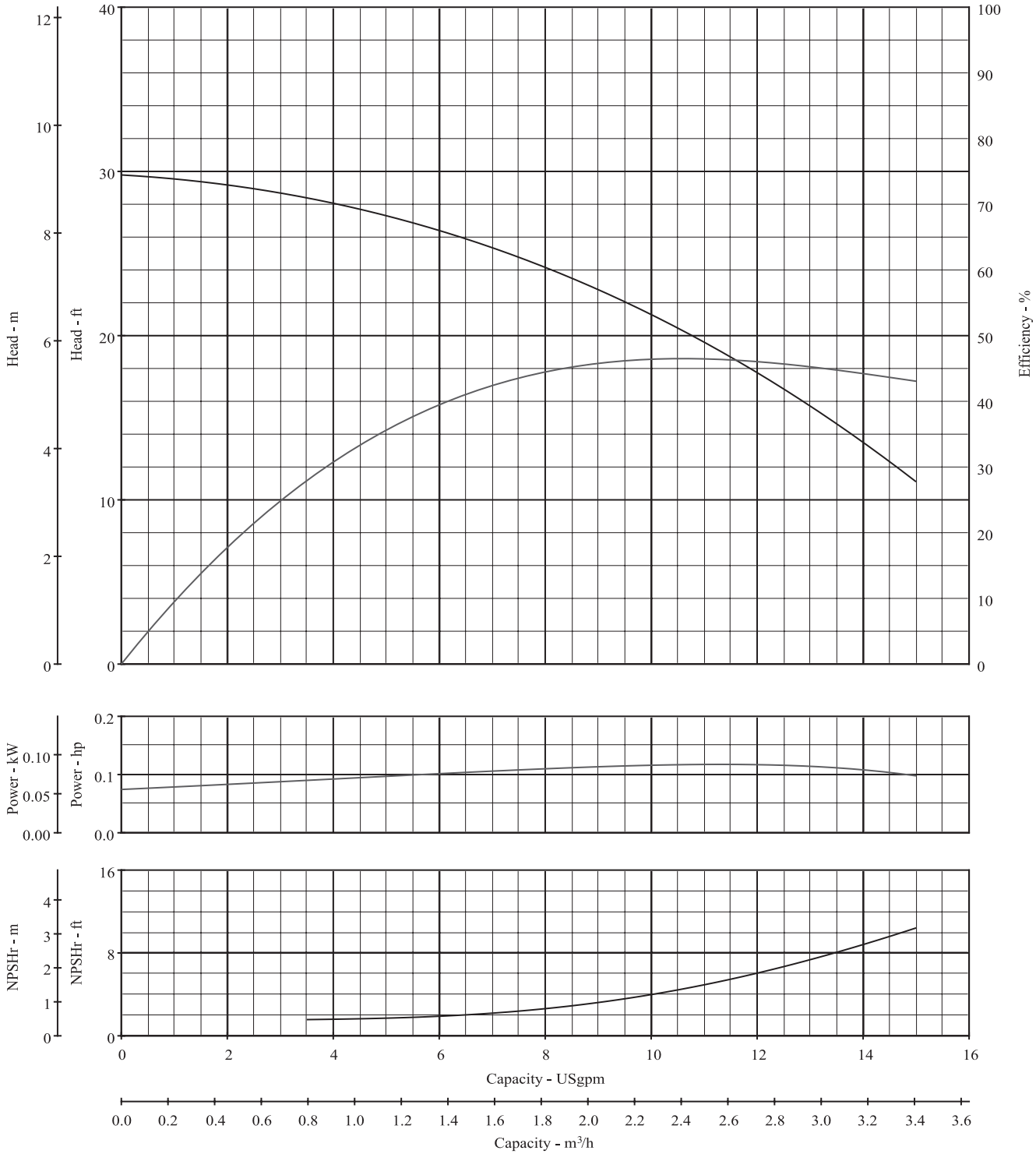

DIMENSIONS AND SPECIFICATIONS CAST IRON CONSTRUCTION 0.33 – 1.5 HP (.246 – 1.12 kW) PUMPS

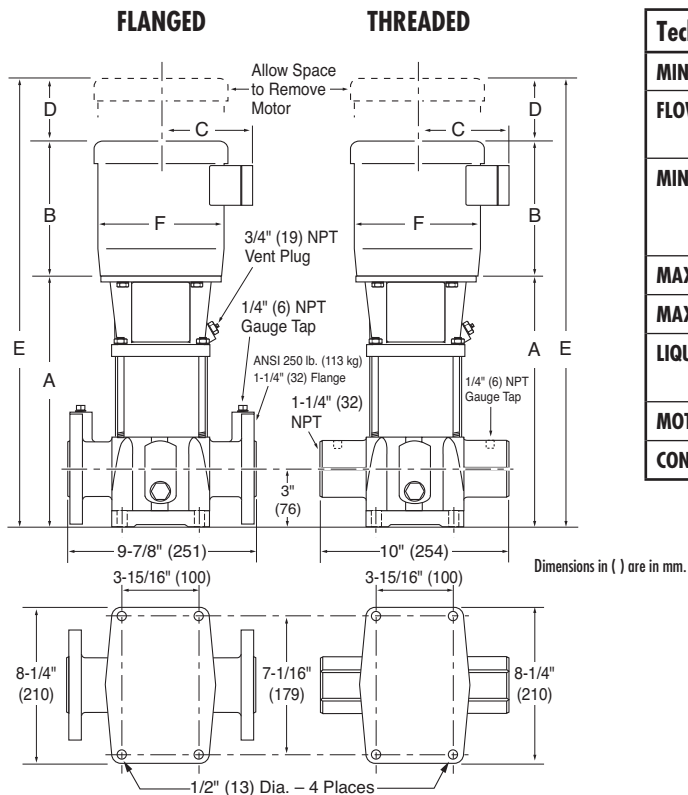
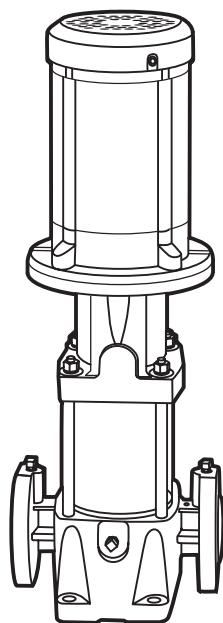

Technical Information	
MINIMUM PUMPING RATES	2 GPM (7.6 LPM)
FLOW RANGE	1 – 16.7 GPM (3.8 – 63.2 LPM)
MIN. SUCTION PIPE SIZES	1-1/4" (32 mm) Nominal Diameter, Schedule 40 Pipe
MAX. WORKING PRESSURE	360 PSI (25 Bar)
MAX. AMBIENT TEMP.	104° F (40° C)
LIQUID TEMP. RANGE	+5° F to +250° F (-15° C to 121° C)
MOTOR OPTIONS	TEFC or ODP
CONSTRUCTION MATERIALS	See Page 16

1-1/4" (32) ANSI 250 lb. (113 kg) 4-Bolt Flange

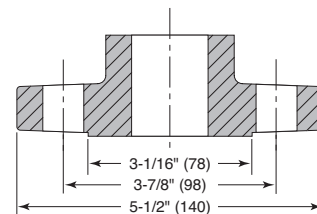

Model Number	HP (kW)	Motor S.F.	ph	Volts	Frame Size	Disc. Size in Inches (mm)	Suction Size in Inches (mm)	Sleeve in Inches (mm)	Dimensions in Inches (mm)*						TEFC Wt. Lbs. (kg)
									A	B	C	D	E	F	
PVM2-30/2D	0.33 (.246)	1.25	1	110/220	56CZ	1.25 (32)	1.25 (32)	1.57 (40)	11.3 (288)	9.3 (236)	4.5 (114)	2.0 (51)	22.6 (575)	6.0 (152)	65 (29)
PVM2-30/2D	0.33 (.246)	1.25	3	190/380	56CZ	1.25 (32)	1.25 (32)	1.57 (40)	11.3 (288)	9.3 (236)	5.2 (132)	2.0 (51)	22.6 (575)	6.2 (157)	76 (34)
PVM2-30D	0.5 (.373)	1.25	1	110/220	56CZ	1.25 (32)	1.25 (32)	1.57 (40)	11.3 (288)	9.3 (236)	4.5 (114)	2.0 (51)	22.6 (575)	6.0 (152)	74 (34)
PVM2-30D	0.5 (.373)	1.25	3	190/380	56CZ	1.25 (32)	1.25 (32)	1.57 (40)	11.3 (288)	9.3 (236)	5.2 (132)	2.0 (51)	22.6 (575)	6.2 (157)	74 (34)
PVM2-40D	0.75 (.559)	1.25	1	110/220	56CZ	1.25 (32)	1.25 (32)	2.28 (58)	12.1 (306)	10.1 (257)	5.3 (135)	2.0 (51)	24.2 (613)	7.2 (183)	81 (37)
PVM2-40D	0.75 (.559)	1.25	3	190/380	56CZ	1.25 (32)	1.25 (32)	2.28 (58)	12.1 (306)	9.3 (236)	5.2 (132)	2.0 (51)	23.4 (593)	6.2 (157)	80 (36)
PVM2-50D	1 (.746)	1.25	1	110/220	56CZ	1.25 (32)	1.25 (32)	2.99 (76)	12.8 (324)	10.1 (257)	5.7 (145)	2.0 (51)	24.9 (631)	7.2 (183)	92 (42)
PVM2-50D	1 (.746)	1.25	3	190/380	56CZ	1.25 (32)	1.25 (32)	2.99 (76)	12.8 (324)	10.1 (257)	5.7 (145)	2.0 (51)	24.9 (631)	7.2 (183)	88 (40)
PVM2-60D	1 (.746)	1.25	1	110/220	56CZ	1.25 (32)	1.25 (32)	3.70 (94)	13.5 (342)	10.1 (257)	5.7 (145)	2.0 (51)	25.6 (649)	7.2 (183)	94 (42)
PVM2-60D	1 (.746)	1.25	3	190/380	56CZ	1.25 (32)	1.25 (32)	3.70 (94)	13.5 (342)	10.1 (257)	5.7 (145)	2.0 (51)	25.6 (649)	7.2 (183)	90 (41)
PVM2-70D	1 (.746)	1.25	1	110/220	56CZ	1.25 (32)	1.25 (32)	4.41 (112)	14.2 (360)	10.1 (257)	5.7 (145)	2.0 (51)	26.3 (667)	7.2 (183)	94 (42)
PVM2-70D	1 (.746)	1.25	3	190/380	56CZ	1.25 (32)	1.25 (32)	4.41 (112)	14.2 (360)	10.1 (257)	5.7 (145)	2.0 (51)	26.3 (667)	7.2 (183)	90 (41)
PVM2-80D	1.5 (1.12)	1.25	1	110/220	56CZ	1.25 (32)	1.25 (32)	5.12 (130)	14.9 (378)	10.1 (257)	5.7 (145)	2.0 (51)	27.0 (685)	7.2 (183)	103 (47)
PVM2-80D	1.5 (1.12)	1.25	3	190/380	56CZ	1.25 (32)	1.25 (32)	5.12 (130)	14.9 (378)	10.1 (257)	5.7 (145)	2.0 (51)	27.0 (685)	7.2 (183)	99 (45)

*Measurements represent the largest number possible for each model using standard efficiency motors.
Weight may vary from published information.

AURORA PVM2 SERIES

DIMENSIONS AND SPECIFICATIONS
 CAST IRON CONSTRUCTION
 2 – 3 HP (1.49 – 2.24 kW) PUMPS

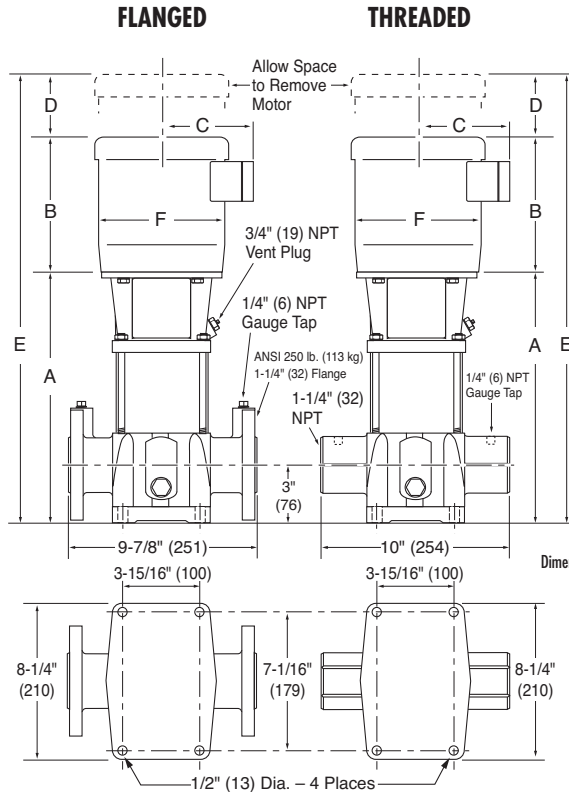
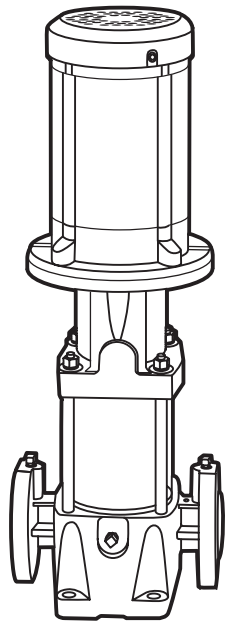

Technical Information	
MINIMUM PUMPING RATES	2 GPM (7.6 LPM)
FLOW RANGE	1 – 16.7 GPM (3.8 – 63.2 LPM)
MIN. SUCTION PIPE SIZES	1-1/4" (32 mm) Nominal Diameter, Schedule 40 Pipe
MAX. WORKING PRESSURE	360 PSI (25 Bar)
MAX. AMBIENT TEMP.	104° F (40° C)
LIQUID TEMP. RANGE	+5° F to +250° F (-15° C to 121° C)
MOTOR OPTIONS	TEFC or ODP
CONSTRUCTION MATERIALS	See Page 16

1-1/4" (32) ANSI, 250 lb. (113 kg) 4-Bolt Flange

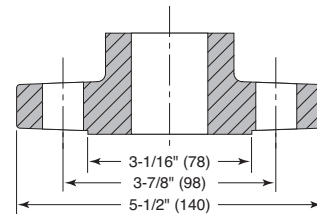

Model Number	HP (kW)	Motor S.F.	ph	Volts	Frame Size	Disc. Size in Inches (mm)	Suction Size in Inches (mm)	Sleeve in Inches (mm)	Dimensions in Inches (mm)*						TEFC Wt. Lbs. (kg)
									A	B	C	D	E	F	
PVM2-90D	1.5 (1.12)	1.4	1	110/220	56CZ	1.25 (32)	1.25 (32)	5.83 (148)	15.8 (401)	12.6 (320)	6.8 (173)	2.6 (66)	31.0 (787)	8.9 (226)	103 (47)
PVM2-90D	1.5 (1.12)	1.4	3	190/380	56CZ	1.25 (32)	1.25 (32)	5.83 (148)	15.8 (401)	12.6 (320)	6.9 (175)	2.6 (66)	31.0 (787)	8.6 (218)	99 (45)
PVM2-100D	2 (1.49)	1.4	1	110/220	182TCZ	1.25 (32)	1.25 (32)	6.54 (166)	16.5 (419)	12.6 (320)	6.8 (173)	2.6 (66)	31.7 (805)	8.9 (226)	140 (64)
PVM2-100D	2 (1.49)	1.4	3	190/380	182TCZ	1.25 (32)	1.25 (32)	6.54 (166)	16.5 (419)	12.6 (320)	6.9 (175)	2.6 (66)	31.7 (805)	8.6 (218)	120 (55)
PVM2-110D	2 (1.49)	1.4	1	110/220	182TCZ	1.25 (32)	1.25 (32)	7.24 (184)	17.2 (437)	12.6 (320)	6.8 (173)	2.6 (66)	32.4 (823)	8.9 (226)	142 (64)
PVM2-110D	2 (1.49)	1.4	3	190/380	182TCZ	1.25 (32)	1.25 (32)	7.24 (184)	17.2 (437)	12.6 (320)	6.9 (175)	2.6 (66)	32.4 (823)	8.6 (218)	122 (55)
PVM2-120D	2 (1.49)	1.4	1	110/220	182TCZ	1.25 (32)	1.25 (32)	7.95 (202)	17.9 (455)	12.6 (320)	6.8 (173)	2.6 (66)	33.1 (841)	8.9 (226)	143 (65)
PVM2-120D	2 (1.49)	1.4	3	190/380	182TCZ	1.25 (32)	1.25 (32)	7.95 (202)	17.9 (455)	12.6 (320)	6.9 (175)	2.6 (66)	33.1 (841)	8.6 (218)	123 (56)
PVM2-130D	2 (1.49)	1.4	1	110/220	213TCZ	1.25 (32)	1.25 (32)	8.66 (220)	18.6 (472)	13.9 (353)	7.9 (201)	2.6 (66)	35.1 (892)	10.0 (254)	148 (67)
PVM2-130D	2 (1.49)	1.4	3	190/380	184TCZ	1.25 (32)	1.25 (32)	8.66 (220)	18.6 (472)	12.6 (320)	6.9 (175)	2.6 (66)	33.8 (859)	8.6 (218)	128 (58)
PVM2-140D	2 (1.49)	1.4	1	110/220	213TCZ	1.25 (32)	1.25 (32)	9.37 (238)	19.3 (490)	13.9 (353)	7.9 (201)	2.6 (66)	35.8 (909)	10.0 (254)	149 (68)
PVM2-140D	2 (1.49)	1.4	3	190/380	184TCZ	1.25 (32)	1.25 (32)	9.37 (238)	19.3 (490)	12.6 (320)	6.9 (175)	2.6 (66)	34.5 (876)	8.6 (218)	129 (59)
PVM2-150D	3 (2.24)	1.4	1	110/220	182TCZ	1.25 (32)	1.25 (32)	10.08 (256)	20.0 (508)	13.9 (353)	7.9 (201)	2.6 (66)	36.5 (927)	10.0 (254)	171 (78)
PVM2-150D	3 (2.24)	1.4	3	190/380	182TCZ	1.25 (32)	1.25 (32)	10.08 (256)	20.0 (508)	12.6 (320)	6.9 (175)	2.6 (66)	35.2 (894)	8.6 (218)	145 (66)
PVM2-160D	3 (2.24)	1.4	1	110/220	182TCZ	1.25 (32)	1.25 (32)	10.79 (274)	20.8 (528)	13.9 (353)	7.9 (201)	2.6 (66)	37.3 (947)	10.0 (254)	172 (78)
PVM2-160D	3 (2.24)	1.4	3	190/380	182TCZ	1.25 (32)	1.25 (32)	10.79 (274)	20.8 (528)	12.6 (320)	6.9 (175)	2.6 (66)	36.0 (914)	8.6 (218)	146 (66)
PVM2-170D	3 (2.24)	1.4	1	110/220	213TCZ	1.25 (32)	1.25 (32)	11.50 (292)	21.5 (546)	13.9 (353)	7.9 (201)	2.6 (66)	38.0 (965)	10.0 (254)	174 (79)
PVM2-170D	3 (2.24)	1.4	3	190/380	184TCZ	1.25 (32)	1.25 (32)	11.50 (292)	21.5 (546)	12.6 (320)	6.9 (175)	2.6 (66)	36.7 (932)	8.6 (218)	148 (67)
PVM2-180D	3 (2.24)	1.4	1	110/220	213TCZ	1.25 (32)	1.25 (32)	12.20 (310)	22.2 (564)	13.9 (353)	7.9 (201)	2.6 (66)	38.7 (983)	10.0 (254)	175 (79)
PVM2-180D	3 (2.24)	1.4	3	190/380	184TCZ	1.25 (32)	1.25 (32)	12.20 (310)	22.2 (564)	12.6 (320)	6.9 (175)	2.6 (66)	37.4 (950)	8.6 (218)	149 (67)
PVM2-220D	3 (2.24)	1.4	1	110/220	213TCZ	1.25 (32)	1.25 (32)	15.04 (382)	25.0 (635)	13.9 (353)	7.9 (201)	2.6 (66)	41.5 (1054)	10.0 (254)	179 (81)
PVM2-220D	3 (2.24)	1.4	3	190/380	184TCZ	1.25 (32)	1.25 (32)	15.04 (382)	25.0 (635)	12.6 (320)	6.9 (175)	2.6 (66)	40.2 (1021)	8.6 (218)	153 (70)
PVM2-260D	3 (2.24)	1.4	1	110/220	213TCZ	1.25 (32)	1.25 (32)	17.87 (454)	27.8 (706)	13.9 (353)	7.9 (201)	2.6 (66)	44.3 (1125)	10.0 (254)	184 (84)
PVM2-260D	3 (2.24)	1.4	3	190/380	184TCZ	1.25 (32)	1.25 (32)	17.87 (454)	27.8 (706)	12.6 (320)	6.9 (175)	2.6 (66)	43.0 (1092)	8.6 (218)	158 (72)

*Measurements represent the largest number possible for each model using standard efficiency motors. Weight may vary from published information.

DIMENSIONS AND SPECIFICATIONS
 316 SS CONSTRUCTION
 0.33 – 1.5 HP (.246 – 1.12 kW) PUMPS

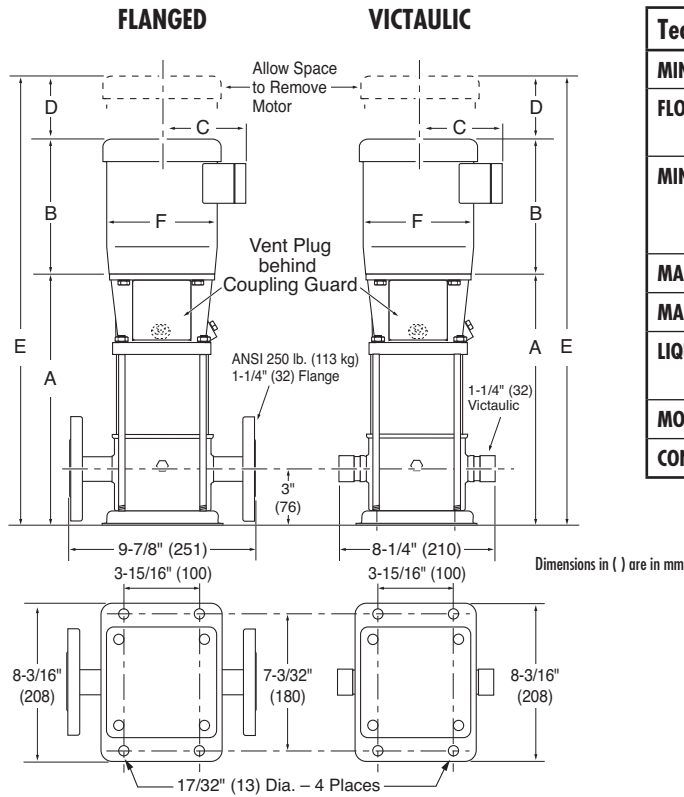
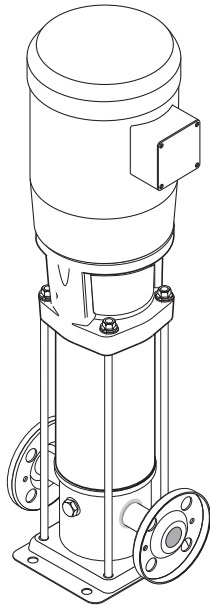

Technical Information	
MINIMUM PUMPING RATES	2 GPM (7.6 LPM)
FLOW RANGE	1 – 16.7 GPM (3.8 – 63.2 LPM)
MIN. SUCTION PIPE SIZES	1-1/4" (32 mm) Nominal Diameter, Schedule 40 Pipe
MAX. WORKING PRESSURE	360 PSI (25 Bar)
MAX. AMBIENT TEMP.	104° F (40° C)
LIQUID TEMP. RANGE	+5° F to +250° F (-15° C to 121° C)
MOTOR OPTIONS	TEFC or ODP
CONSTRUCTION MATERIALS	See Page 16

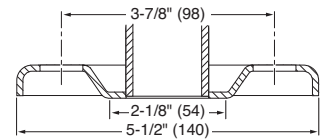

Model Number	HP (kW)	Motor S.F.	ph	Volts	Frame Size	Disc. Size in Inches (mm)	Suction Size in Inches (mm)	Sleeve in Inches (mm)	Dimensions in Inches (mm)*						TEFC Wt. Lbs. (kg)
									A	B	C	D	E	F	
PVM(I/X)2-30/2D	0.33 (.246)	1.25	1	110/220	56CZ	1.25 (32)	1.25 (32)	1.57 (40)	11.9 (303)	9.3 (236)	4.5 (114)	2.0 (51)	23.2 (589)	6.0 (152)	51 (23)
PVM(I/X)2-30/2D	0.33 (.246)	1.25	3	190/380	56CZ	1.25 (32)	1.25 (32)	1.57 (40)	11.9 (303)	9.3 (236)	5.2 (132)	2.0 (51)	23.2 (589)	6.2 (157)	62 (28)
PVM(I/X)2-30D	0.50 (.373)	1.25	1	110/220	56CZ	1.25 (32)	1.25 (32)	1.57 (40)	11.9 (303)	9.3 (236)	4.5 (114)	2.0 (51)	23.2 (589)	6.0 (152)	61 (27)
PVM(I/X)2-30D	0.50 (.373)	1.25	3	190/380	56CZ	1.25 (32)	1.25 (32)	1.57 (40)	11.9 (303)	9.3 (236)	5.2 (132)	2.0 (51)	23.2 (589)	6.2 (157)	61 (27)
PVM(I/X)2-40D	0.75 (.559)	1.25	1	110/220	56CZ	1.25 (32)	1.25 (32)	2.28 (58)	12.6 (321)	10.1 (257)	5.3 (135)	2.0 (51)	24.7 (627)	7.2 (183)	68 (31)
PVM(I/X)2-40D	0.75 (.559)	1.25	3	190/380	56CZ	1.25 (32)	1.25 (32)	2.28 (58)	12.6 (321)	9.3 (236)	5.2 (132)	2.0 (51)	23.9 (607)	6.2 (157)	67 (30)
PVM(I/X)2-50D	1 (.746)	1.25	1	110/220	56CZ	1.25 (32)	1.25 (32)	2.99 (76)	13.3 (339)	10.1 (257)	5.7 (145)	2.0 (51)	25.4 (645)	7.2 (183)	79 (36)
PVM(I/X)2-50D	1 (.746)	1.25	3	190/380	56CZ	1.25 (32)	1.25 (32)	2.99 (76)	13.3 (339)	10.1 (257)	5.7 (145)	2.0 (51)	25.4 (645)	7.2 (183)	75 (34)
PVM(I/X)2-60D	1 (.746)	1.25	1	110/220	56CZ	1.25 (32)	1.25 (32)	3.70 (94)	14.1 (357)	10.1 (257)	5.7 (145)	2.0 (51)	26.2 (665)	7.2 (183)	80 (36)
PVM(I/X)2-60D	1 (.746)	1.25	3	190/380	56CZ	1.25 (32)	1.25 (32)	3.70 (94)	14.1 (357)	10.1 (257)	5.7 (145)	2.0 (51)	26.2 (665)	7.2 (183)	76 (35)
PVM(I/X)2-70D	1 (.746)	1.25	1	110/220	56CZ	1.25 (32)	1.25 (32)	4.41 (112)	14.8 (375)	10.1 (257)	5.7 (145)	2.0 (51)	26.9 (683)	7.2 (183)	94 (42)
PVM(I/X)2-70D	1 (.746)	1.25	3	190/380	56CZ	1.25 (32)	1.25 (32)	4.41 (112)	14.8 (375)	10.1 (257)	5.7 (145)	2.0 (51)	26.9 (683)	7.2 (183)	90 (41)
PVM(I/X)2-80D	1.5 (1.12)	1.25	1	110/220	56CZ	1.25 (32)	1.25 (32)	5.12 (130)	15.5 (393)	10.1 (257)	5.7 (145)	2.0 (51)	27.6 (701)	7.2 (183)	103 (47)
PVM(I/X)2-80D	1.5 (1.12)	1.25	3	190/380	56CZ	1.25 (32)	1.25 (32)	5.12 (130)	15.5 (393)	10.1 (257)	5.7 (145)	2.0 (51)	27.6 (701)	7.2 (183)	99 (45)

*Measurements represent the largest number possible for each model using standard efficiency motors.

AURORA PVMX2 SERIES

DIMENSIONS AND SPECIFICATIONS

316 SS CONSTRUCTION

2 – 3 HP (1.49 – 2.24 kW) PUMPS

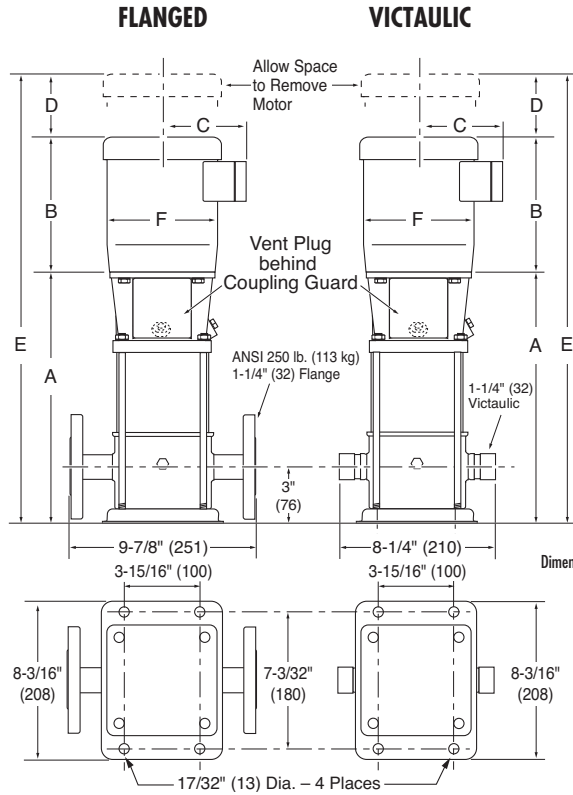
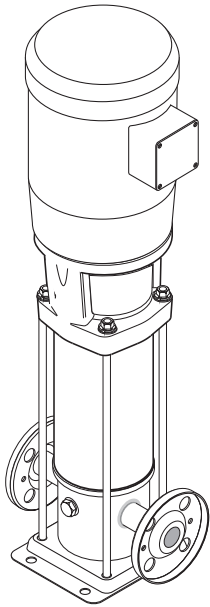

Dimensions in () are in mm.

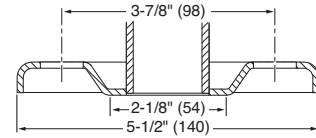

Technical Information	
MINIMUM PUMPING RATES	2 GPM (7.6 LPM)
FLOW RANGE	1 – 16.7 GPM (3.8 – 63.2 LPM)
MIN. SUCTION PIPE SIZES	1-1/4" (32 mm) Nominal Diameter, Schedule 40 Pipe
MAX. WORKING PRESSURE	360 PSI (25 Bar)
MAX. AMBIENT TEMP.	104° F (40° C)
LIQUID TEMP. RANGE	+5° F to +250° F (-15° C to 121° C)
MOTOR OPTIONS	TEFC or ODP
CONSTRUCTION MATERIALS	See Page 16

Model Number	HP (kW)	Motor S.F.	ph	Volts	Frame Size	Disc. Size in Inches (mm)	Suction Size in Inches (mm)	Sleeve in Inches (mm)	Dimensions in Inches (mm)*						TEFC Wt. Lbs. (kg)
									A	B	C	D	E	F	
PVM(I/X)2-90D	1.5 (1.12)	1.4	1	110/220	56CZ	1.25 (32)	1.25 (32)	5.83 (148)	16.2 (411)	12.6 (320)	6.8 (173)	2.6 (66)	31.4 (798)	8.9 (226)	103 (47)
PVM(I/X)2-90D	1.5 (1.12)	1.4	3	190/380	56CZ	1.25 (32)	1.25 (32)	5.83 (148)	16.2 (411)	12.6 (320)	6.9 (175)	2.6 (66)	31.4 (798)	8.6 (218)	99 (45)
PVM(I/X)2-100D	2 (1.49)	1.4	1	110/220	182TCZ	1.25 (32)	1.25 (32)	6.54 (166)	16.9 (429)	12.6 (320)	6.8 (173)	2.6 (66)	32.1 (815)	8.9 (226)	127 (58)
PVM(I/X)2-100D	2 (1.49)	1.4	3	190/380	182TCZ	1.25 (32)	1.25 (32)	6.54 (166)	16.9 (429)	12.6 (320)	6.9 (175)	2.6 (66)	32.1 (815)	8.6 (218)	107 (48)
PVM(I/X)2-110D	2 (1.49)	1.4	1	110/220	182TCZ	1.25 (32)	1.25 (32)	7.24 (184)	17.6 (447)	12.6 (320)	6.8 (173)	2.6 (66)	32.8 (833)	8.9 (226)	128 (58)
PVM(I/X)2-110D	2 (1.49)	1.4	3	190/380	182TCZ	1.25 (32)	1.25 (32)	7.24 (184)	17.6 (447)	12.6 (320)	6.9 (175)	2.6 (66)	32.8 (833)	8.6 (218)	108 (49)
PVM(I/X)2-120D	2 (1.49)	1.4	1	110/220	182TCZ	1.25 (32)	1.25 (32)	7.95 (202)	18.3 (465)	12.6 (320)	6.8 (173)	2.6 (66)	33.5 (851)	8.9 (226)	129 (59)
PVM(I/X)2-120D	2 (1.49)	1.4	3	190/380	182TCZ	1.25 (32)	1.25 (32)	7.95 (202)	18.3 (465)	12.6 (320)	6.9 (175)	2.6 (66)	33.5 (851)	8.6 (218)	109 (50)
PVM(I/X)2-130D	3 (2.24)	1.4	1	110/220	182TCZ	1.25 (32)	1.25 (32)	8.66 (220)	19.0 (483)	13.9 (353)	7.9 (201)	2.6 (66)	35.5 (902)	10.0 (254)	134 (61)
PVM(I/X)2-130D	3 (2.24)	1.4	3	190/380	182TCZ	1.25 (32)	1.25 (32)	8.66 (220)	19.0 (483)	12.6 (320)	6.9 (175)	2.6 (66)	34.2 (869)	8.6 (218)	114 (52)
PVM(I/X)2-140D	3 (2.24)	1.4	1	110/220	182TCZ	1.25 (32)	1.25 (32)	9.37 (238)	19.7 (501)	13.9 (353)	7.9 (201)	2.6 (66)	36.2 (919)	10.0 (254)	135 (61)
PVM(I/X)2-140D	3 (2.24)	1.4	3	190/380	182TCZ	1.25 (32)	1.25 (32)	9.37 (238)	19.7 (501)	12.6 (320)	6.9 (175)	2.6 (66)	34.9 (886)	8.6 (218)	115 (52)
PVM(I/X)2-150D	3 (2.24)	1.4	1	110/220	213TCZ	1.25 (32)	1.25 (32)	10.08 (256)	20.4 (519)	13.9 (353)	7.9 (201)	2.6 (66)	36.9 (937)	10.0 (254)	158 (71)
PVM(I/X)2-150D	3 (2.24)	1.4	3	190/380	184TCZ	1.25 (32)	1.25 (32)	10.08 (256)	20.4 (519)	12.6 (320)	6.9 (175)	2.6 (66)	35.6 (904)	8.6 (218)	132 (60)
PVM(I/X)2-160D	3 (2.24)	1.4	1	110/220	213TCZ	1.25 (32)	1.25 (32)	10.79 (274)	21.1 (537)	13.9 (353)	7.9 (201)	2.6 (66)	37.6 (955)	10.0 (254)	159 (72)
PVM(I/X)2-160D	3 (2.24)	1.4	3	190/380	184TCZ	1.25 (32)	1.25 (32)	10.79 (274)	21.1 (537)	12.6 (320)	6.9 (175)	2.6 (66)	36.3 (922)	8.6 (218)	133 (60)
PVM(I/X)2-170D	3 (2.24)	1.4	1	110/220	213TCZ	1.25 (32)	1.25 (32)	11.50 (292)	21.8 (555)	13.9 (353)	7.9 (201)	2.6 (66)	38.3 (973)	10.0 (254)	160 (73)
PVM(I/X)2-170D	3 (2.24)	1.4	3	190/380	184TCZ	1.25 (32)	1.25 (32)	11.50 (292)	21.8 (555)	12.6 (320)	6.9 (175)	2.6 (66)	37.0 (940)	8.6 (218)	134 (61)
PVM(I/X)2-180D	3 (2.24)	1.4	1	110/220	213TCZ	1.25 (32)	1.25 (32)	12.20 (310)	22.6 (573)	13.9 (353)	7.9 (201)	2.6 (66)	39.1 (993)	10.0 (254)	161 (73)
PVM(I/X)2-180D	3 (2.24)	1.4	3	190/380	184TCZ	1.25 (32)	1.25 (32)	12.20 (310)	22.6 (573)	12.6 (320)	6.9 (175)	2.6 (66)	37.8 (960)	8.6 (218)	135 (61)
PVM(I/X)2-220D	3 (2.24)	1.4	1	110/220	213TCZ	1.25 (32)	1.25 (32)	15.04 (382)	25.4 (645)	13.9 (353)	7.9 (201)	2.6 (66)	41.9 (1064)	10.0 (254)	166 (75)
PVM(I/X)2-220D	3 (2.24)	1.4	3	190/380	184TCZ	1.25 (32)	1.25 (32)	15.04 (382)	25.4 (645)	12.6 (320)	6.9 (175)	2.6 (66)	40.6 (1031)	8.6 (218)	140 (63)
PVM(I/X)2-260D	3 (2.24)	1.4	1	110/220	213TCZ	1.25 (32)	1.25 (32)	17.87 (454)	28.2 (717)	13.9 (353)	7.9 (201)	2.6 (66)	44.7 (1135)	10.0 (254)	171 (77)
PVM(I/X)2-260D	3 (2.24)	1.4	3	190/380	184TCZ	1.25 (32)	1.25 (32)	17.87 (454)	28.2 (717)	12.6 (320)	6.9 (175)	2.6 (66)	43.4 (1102)	8.6 (218)	145 (66)

*Measurements represent the largest number possible for each model using standard efficiency motors.

PERFORMANCE CURVES

NOMINAL RPM: 2875 BASED ON FRESH WATER @ 68° F (20° C) MAXIMUM WORKING PRESSURE: 360 PSI (25 BAR)

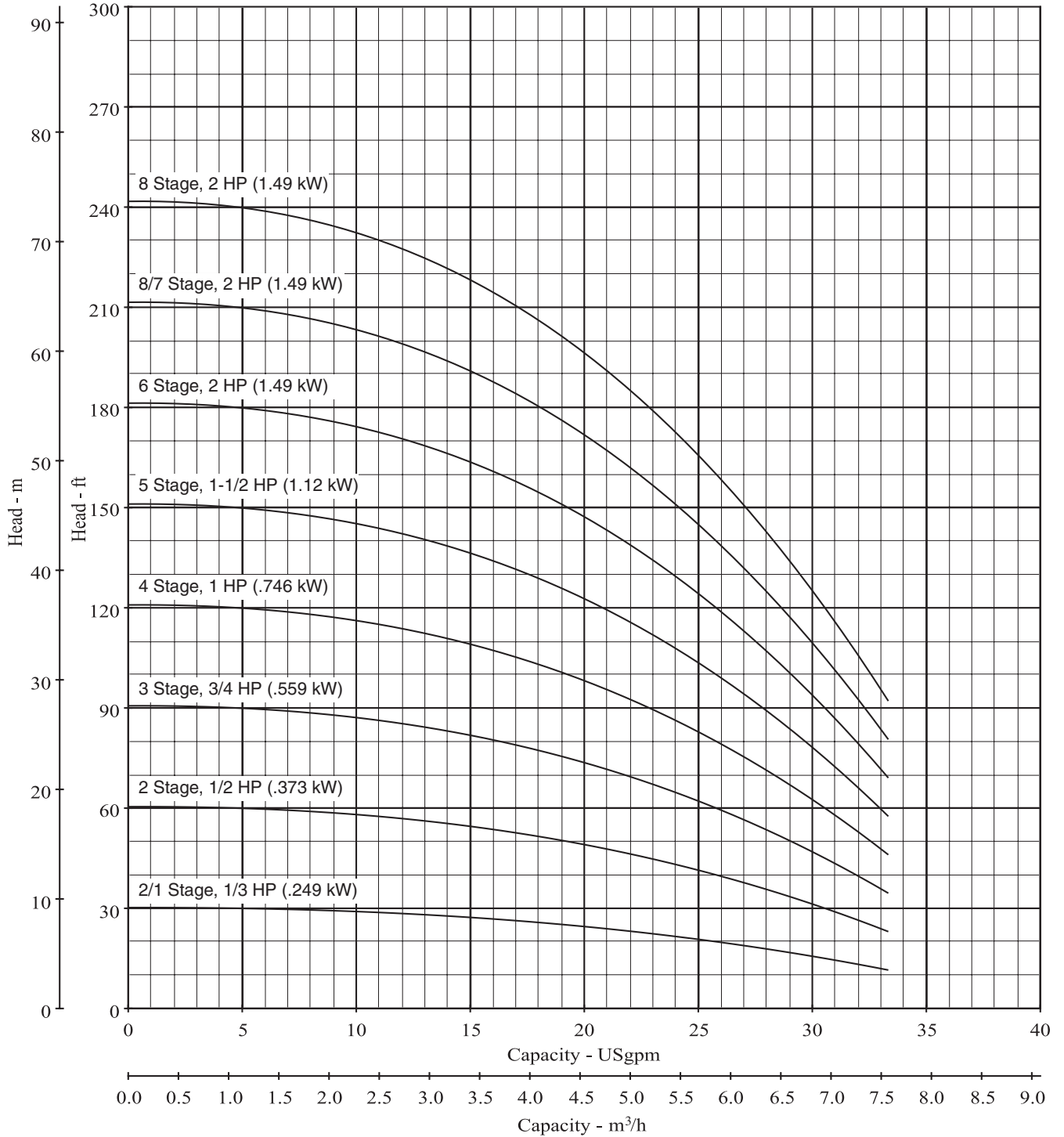

AURORA PVM(X)4 SERIES

PERFORMANCE CURVES

NOMINAL RPM: 2875

BASED ON FRESH WATER @ 68° F (20° C)

MAXIMUM WORKING PRESSURE: 360 PSI (25 BAR)

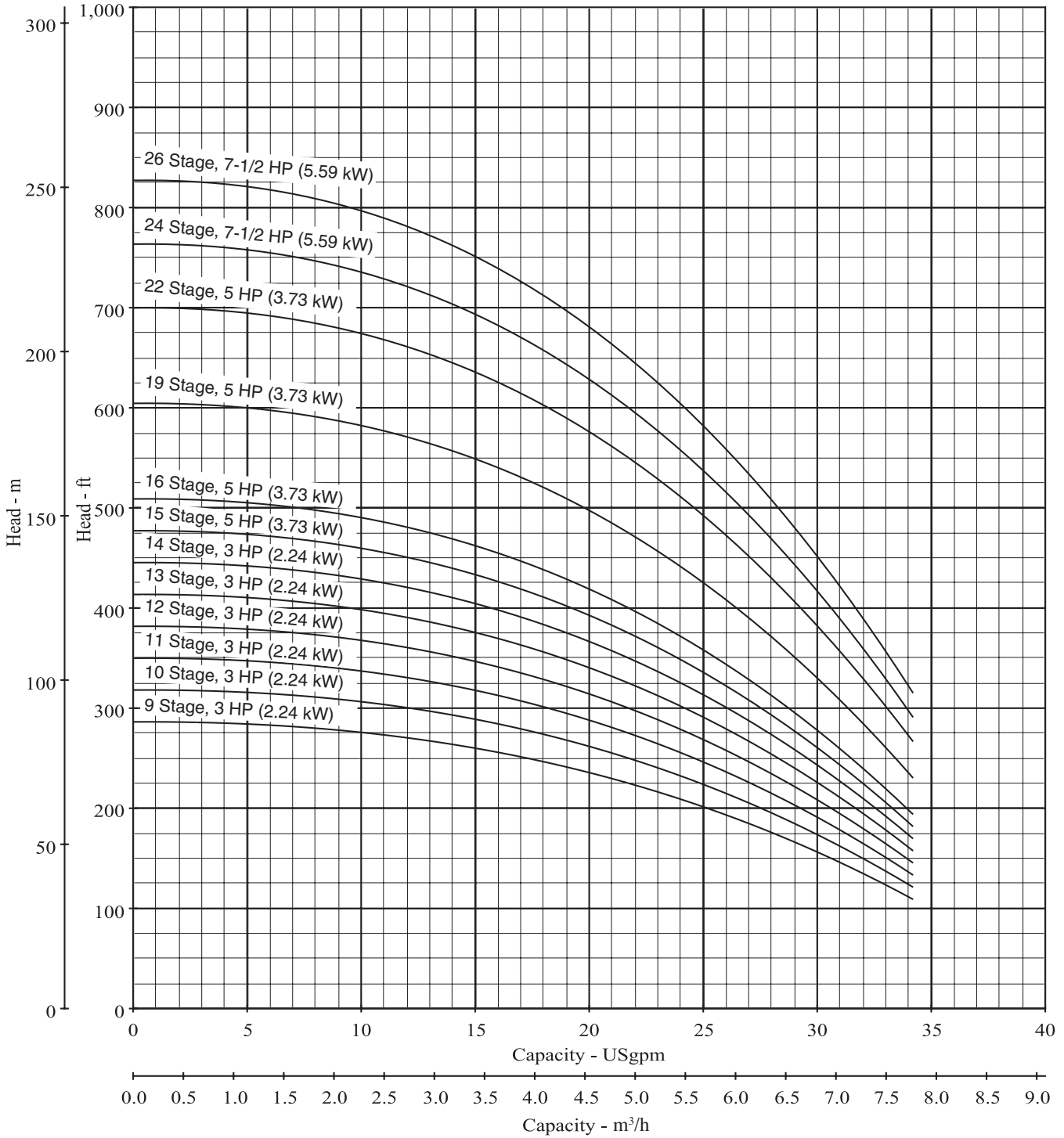

AURORA PVM(X)4 SERIES

SINGLE STAGE PERFORMANCE DATA

NOMINAL RPM: 2875

BASED ON FRESH WATER @ 68° F (20° C)

MAXIMUM WORKING PRESSURE: 360 PSI (25 BAR)

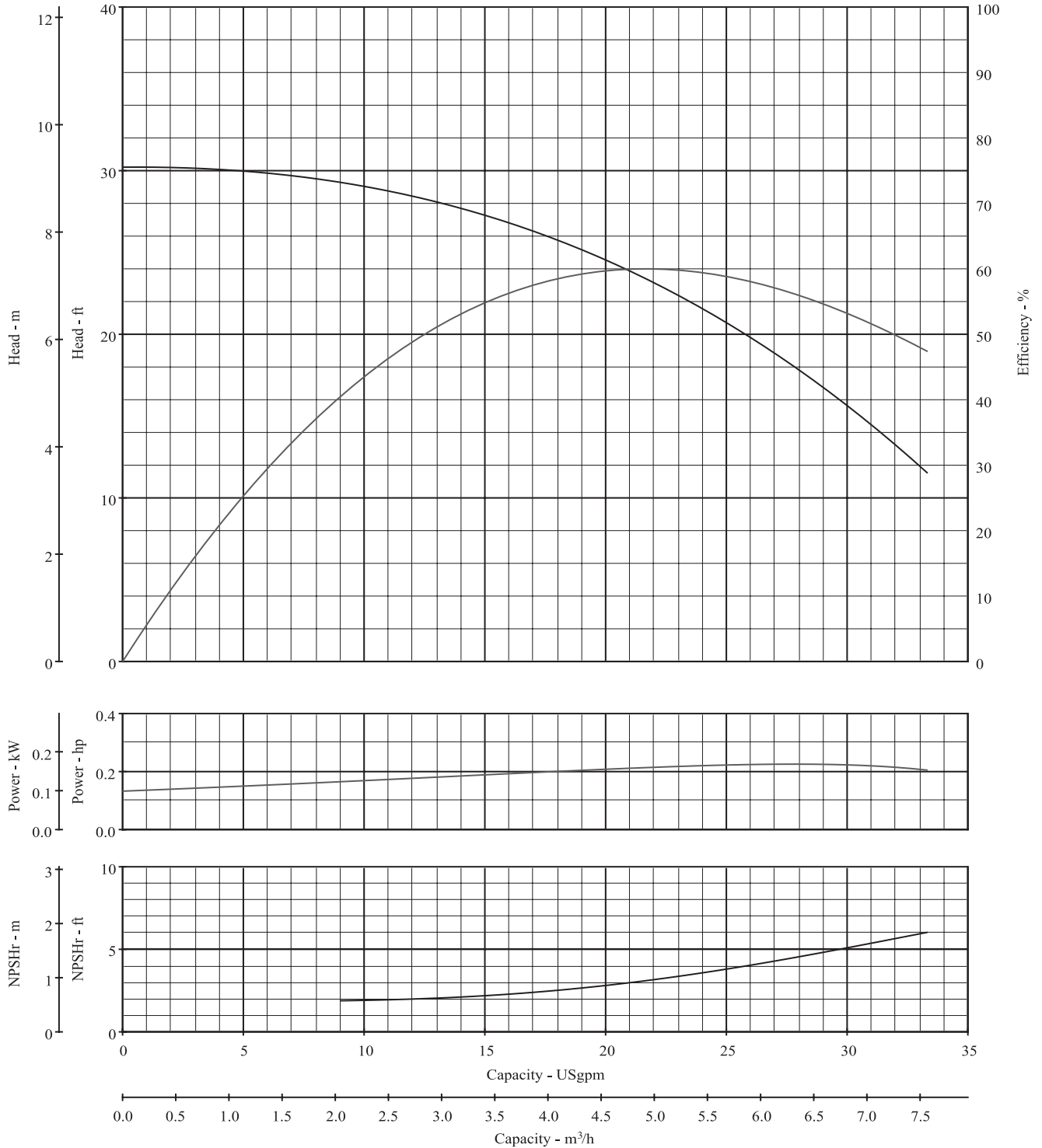

AURORA PVM4 SERIES

DIMENSIONS AND SPECIFICATIONS

CAST IRON CONSTRUCTION

0.33 – 1.5 HP (.246 – 1.12 kW) PUMPS

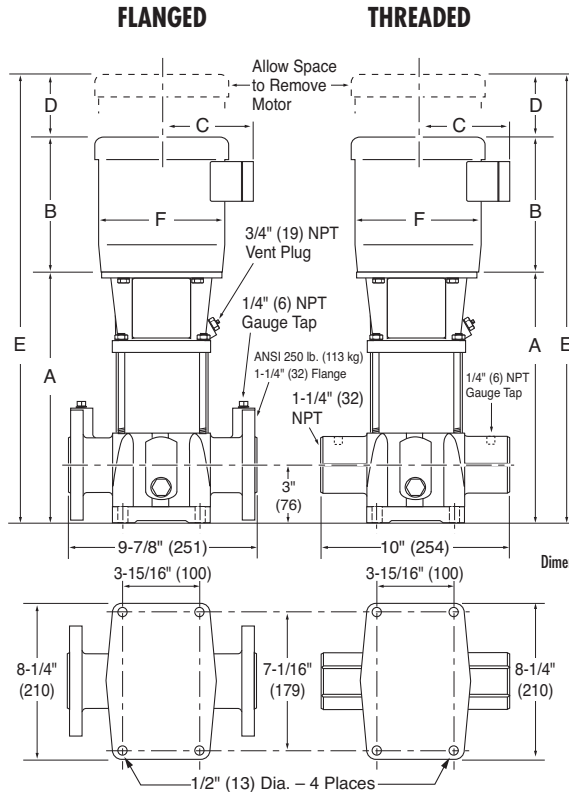
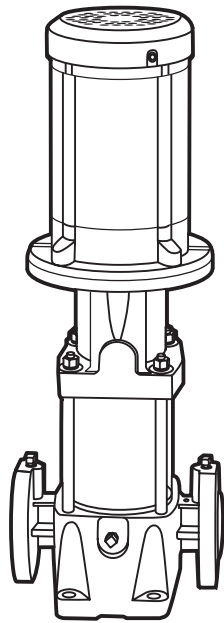

TECHNICAL INFORMATION	
MINIMUM PUMPING RATES	2.5 GPM (9.5 LPM)
FLOW RANGE	2.5 – 33 GPM (9.5 – 124.9 LPM)
MIN. SUCTION PIPE SIZES	1-1/4" (32 mm) Nominal Diameter, Schedule 40 Pipe
MAX. WORKING PRESSURE	360 PSI (25 Bar)
MAX. AMBIENT TEMP.	104° F (40° C)
LIQUID TEMP. RANGE	+5° F to +250° F (-15° C to 121° C)
MOTOR OPTIONS	TEFC or ODP
CONSTRUCTION MATERIALS	See Page 16

1-1/4" (32) ANSI, 250 lb. (113 kg) 4-Bolt Flange

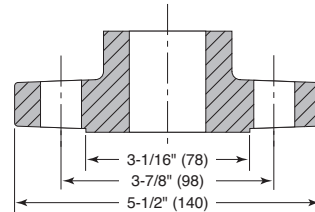

Model Number	HP (kW)	Motor S.F.	ph	Volts	Frame Size	Disc. Size in Inches (mm)	Suction Size in Inches (mm)	Sleeve in Inches (mm)	Dimensions in Inches (mm)*						TEFC Wt. Lbs. (kg)
									A	B	C	D	E	F	
PVM4-20/1D	0.33 (.246)	1.25	1	110/220	56CZ	1.25 (32)	1.25 (32)	1.57 (40)	11.3 (287)	9.3 (236)	4.5 (114)	2.0 (51)	22.6 (574)	6.0 (152)	64 (29)
PVM4-20/1D	0.33 (.246)	1.25	3	190/380	56CZ	1.25 (32)	1.25 (32)	1.57 (40)	11.3 (287)	9.3 (236)	5.2 (132)	2.0 (51)	22.6 (574)	6.2 (157)	75 (34)
PVM4-20D	0.50 (.373)	1.25	1	110/220	56CZ	1.25 (32)	1.25 (32)	1.57 (40)	11.3 (287)	9.3 (236)	4.5 (114)	2.0 (51)	22.6 (574)	6.0 (152)	73 (33)
PVM4-20D	0.50 (.373)	1.25	3	190/380	56CZ	1.25 (32)	1.25 (32)	1.57 (40)	11.3 (287)	9.3 (236)	5.2 (132)	2.0 (51)	22.6 (574)	6.2 (157)	73 (33)
PVM4-30D	0.75 (.559)	1.25	1	110/220	56CZ	1.25 (32)	1.25 (32)	2.64 (67)	12.4 (315)	10.1 (257)	5.3 (135)	2.0 (51)	24.5 (622)	7.2 (183)	80 (36)
PVM4-30D	0.75 (.559)	1.25	3	190/380	56CZ	1.25 (32)	1.25 (32)	2.64 (67)	12.4 (315)	9.3 (236)	5.2 (132)	2.0 (51)	23.7 (602)	6.2 (157)	79 (36)
PVM4-40D	1 (.746)	1.25	1	110/220	56CZ	1.25 (32)	1.25 (32)	3.70 (94)	13.5 (343)	10.1 (257)	5.7 (145)	2.0 (51)	25.6 (650)	7.2 (183)	92 (42)
PVM4-40D	1 (.746)	1.25	3	190/380	56CZ	1.25 (32)	1.25 (32)	3.70 (94)	13.5 (343)	10.1 (257)	5.7 (145)	2.0 (51)	25.6 (650)	7.2 (183)	88 (40)
PVM4-50D	1.5 (1.12)	1.25	1	110/220	56CZ	1.25 (32)	1.25 (32)	4.76 (121)	14.5 (368)	10.1 (257)	5.7 (145)	2.0 (51)	26.6 (676)	7.2 (183)	100 (45)
PVM4-50D	1.5 (1.12)	1.25	3	190/380	56CZ	1.25 (32)	1.25 (32)	4.76 (121)	14.5 (368)	10.1 (257)	5.7 (145)	2.0 (51)	26.6 (676)	7.2 (183)	96 (44)

*Measurements represent the largest number possible for each model using standard efficiency motors.

DIMENSIONS AND SPECIFICATIONS CAST IRON CONSTRUCTION 2 – 7.5 HP (1.49 – 5.59 kW) PUMPS

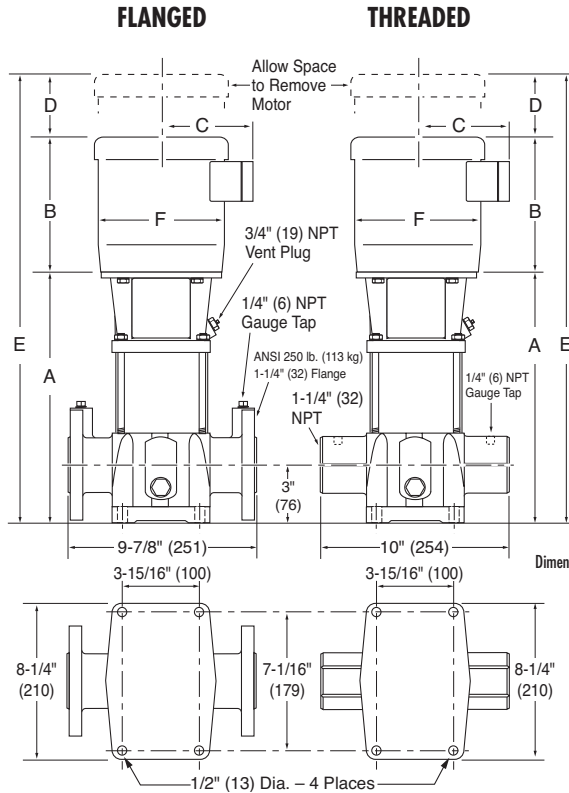
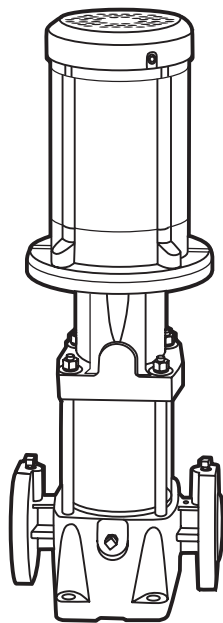

TECHNICAL INFORMATION	
MINIMUM PUMPING RATES	2.5 GPM (9.5 LPM)
FLOW RANGE	2.5 – 33 GPM (9.5 – 124.9 LPM)
MIN. SUCTION PIPE SIZES	1-1/4" (32 mm) Nominal Diameter, Schedule 40 Pipe
MAX. WORKING PRESSURE	360 PSI (25 Bar)
MAX. AMBIENT TEMP.	104° F (40° C)
LIQUID TEMP. RANGE	+5° F to +250° F (-15° C to 121° C)
MOTOR OPTIONS	TEFC or ODP
CONSTRUCTION MATERIALS	See Page 16

1-1/4" (32) ANSI 250 lb. (113 kg) 4-Bolt Flange

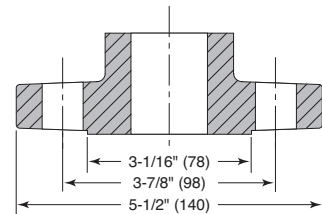

Model Number	HP (kW)	Motor S.F.	ph	Volts	Frame Size	Disc. Size in Inches (mm)	Suction Size in Inches (mm)	Sleeve in Inches (mm)	Dimensions in Inches (mm)*						TEFC Wt. Lbs. (kg)
									A	B	C	D	E	F	
PVM4-60D	2 (1.49)	1.4	1	110/220	182TCZ	1.25 (32)	1.25 (32)	5.83 (148)	15.8 (401)	13.9 (353)	7.9 (201)	2.6 (66)	32.3 (820)	10.0 (254)	140 (64)
PVM4-60D	2 (1.49)	1.4	3	190/380	182TCZ	1.25 (32)	1.25 (32)	5.83 (148)	15.8 (401)	12.6 (320)	6.9 (175)	2.6 (66)	31.0 (787)	8.6 (218)	120 (54)
PVM4-80/7D	2 (1.49)	1.4	1	110/220	182TCZ	1.25 (32)	1.25 (32)	7.95 (202)	17.9 (455)	13.9 (353)	7.9 (201)	2.6 (66)	34.4 (874)	10.0 (254)	143 (65)
PVM4-80/7D	2 (1.49)	1.4	3	190/380	182TCZ	1.25 (32)	1.25 (32)	7.95 (202)	17.9 (455)	12.6 (320)	6.9 (175)	2.6 (66)	33.1 (841)	8.6 (218)	123 (56)
PVM4-80D	2 (1.49)	1.4	1	110/220	182TCZ	1.25 (32)	1.25 (32)	7.95 (202)	17.9 (455)	12.6 (320)	7.9 (201)	2.6 (66)	34.4 (874)	10.0 (254)	143 (65)
PVM4-80D	2 (1.49)	1.4	3	190/380	182TCZ	1.25 (32)	1.25 (32)	7.95 (202)	17.9 (455)	12.6 (320)	6.9 (175)	2.6 (66)	33.1 (841)	8.6 (218)	123 (56)
PVM4-90D	3 (2.24)	1.4	1	110/220	213TCZ	1.25 (32)	1.25 (32)	9.02 (229)	19.0 (482)	13.9 (353)	7.9 (201)	2.6 (66)	35.5 (902)	10.0 (254)	165 (75)
PVM4-90D	3 (2.24)	1.4	3	190/380	184TCZ	1.25 (32)	1.25 (32)	9.02 (229)	19.0 (482)	12.6 (320)	6.9 (175)	2.6 (66)	34.2 (869)	8.6 (218)	139 (63)
PVM4-100D	3 (2.24)	1.4	1	110/220	213TCZ	1.25 (32)	1.25 (32)	10.08 (256)	20.0 (509)	13.9 (353)	7.9 (201)	2.6 (66)	36.5 (927)	10.0 (254)	166 (75)
PVM4-100D	3 (2.24)	1.4	3	190/380	184TCZ	1.25 (32)	1.25 (32)	10.08 (256)	20.0 (509)	12.6 (320)	6.9 (175)	2.6 (66)	35.2 (894)	8.6 (218)	140 (64)
PVM4-110D	3 (2.24)	1.4	1	110/220	213TCZ	1.25 (32)	1.25 (32)	11.14 (283)	21.1 (536)	13.9 (353)	7.9 (201)	2.6 (66)	37.6 (955)	10.0 (254)	167 (76)
PVM4-110D	3 (2.24)	1.4	3	190/380	184TCZ	1.25 (32)	1.25 (32)	11.14 (283)	21.1 (536)	12.6 (320)	6.9 (175)	2.6 (66)	36.3 (922)	8.6 (218)	141 (64)
PVM4-120D	3 (2.24)	1.4	1	110/220	213TCZ	1.25 (32)	1.25 (32)	12.20 (310)	22.2 (563)	13.9 (353)	7.9 (201)	2.6 (66)	38.7 (983)	10.0 (254)	169 (77)
PVM4-120D	3 (2.24)	1.4	3	190/380	184TCZ	1.25 (32)	1.25 (32)	12.20 (310)	22.2 (563)	12.6 (320)	6.9 (175)	2.6 (66)	37.4 (950)	8.6 (218)	143 (65)
PVM4-130D	3 (2.24)	1.4	1	110/220	213TCZ	1.25 (32)	1.25 (32)	13.27 (337)	23.2 (590)	13.9 (353)	7.9 (201)	2.6 (66)	39.7 (1008)	10.0 (254)	170 (77)
PVM4-130D	3 (2.24)	1.4	3	190/380	184TCZ	1.25 (32)	1.25 (32)	13.27 (337)	23.2 (590)	12.6 (320)	6.9 (175)	2.6 (66)	38.4 (975)	8.6 (218)	144 (65)
PVM4-140D	3 (2.24)	1.4	1	110/220	213TCZ	1.25 (32)	1.25 (32)	14.33 (364)	24.3 (617)	13.9 (353)	7.9 (201)	2.6 (66)	40.8 (1036)	10.0 (254)	171 (78)
PVM4-140D	3 (2.24)	1.4	3	190/380	184TCZ	1.25 (32)	1.25 (32)	14.33 (364)	24.3 (617)	12.6 (320)	6.9 (175)	2.6 (66)	39.5 (1003)	8.6 (218)	145 (66)
PVM4-150D	5 (3.73)	1.4	1	110/220	213TCZ	1.25 (32)	1.25 (32)	15.39 (391)	25.4 (644)	13.9 (353)	7.9 (201)	2.6 (66)	41.9 (1064)	10.0 (254)	187 (85)
PVM4-150D	5 (3.73)	1.4	3	190/380	213TCZ	1.25 (32)	1.25 (32)	15.39 (391)	25.4 (644)	13.9 (353)	8.1 (206)	2.6 (66)	41.9 (1064)	10.3 (262)	191 (86)
PVM4-160D	5 (3.73)	1.4	1	110/220	213TCZ	1.25 (32)	1.25 (32)	16.46 (418)	26.4 (671)	13.9 (353)	7.9 (201)	2.6 (66)	42.9 (1090)	10.0 (254)	188 (85)
PVM4-160D	5 (3.73)	1.4	3	190/380	213TCZ	1.25 (32)	1.25 (32)	16.46 (418)	26.4 (671)	13.9 (353)	8.1 (206)	2.6 (66)	42.9 (1090)	10.3 (262)	192 (87)
PVM4-190D	5 (3.73)	1.4	1	110/220	213TCZ	1.25 (32)	1.25 (32)	19.65 (499)	29.6 (752)	13.9 (353)	7.9 (201)	2.6 (66)	46.1 (1171)	10.0 (254)	192 (87)
PVM4-190D	5 (3.73)	1.4	3	190/380	213TCZ	1.25 (32)	1.25 (32)	19.65 (499)	29.6 (752)	13.9 (353)	8.1 (206)	2.6 (66)	46.1 (1171)	10.3 (262)	196 (89)
PVM4-220D	5 (3.73)	1.4	1	110/220	213TCZ	1.25 (32)	1.25 (32)	22.83 (580)	32.8 (833)	13.9 (353)	7.9 (201)	2.6 (66)	49.3 (1252)	10.0 (254)	195 (89)
PVM4-220D	5 (3.73)	1.4	3	190/380	213TCZ	1.25 (32)	1.25 (32)	22.83 (580)	32.8 (833)	13.9 (353)	8.1 (206)	2.6 (66)	49.3 (1252)	10.3 (262)	199 (90)
PVM4-240D	7.5 (5.59)	1.15	1	110/220	213TCZ	1.25 (32)	1.25 (32)	24.96 (634)	34.9 (887)	13.9 (353)	7.9 (201)	3.1 (79)	51.9 (1318)	10.0 (254)	228 (103)
PVM4-240D	7.5 (5.59)	1.15	3	190/380	213TCZ	1.25 (32)	1.25 (32)	24.96 (634)	34.9 (887)	13.9 (353)	8.1 (206)	3.1 (79)	51.9 (1318)	10.3 (262)	225 (102)
PVM4-260D	7.5 (5.59)	1.15	1	110/220	213TCZ	1.25 (32)	1.25 (32)	27.09 (688)	37.1 (941)	13.9 (353)	7.9 (201)	3.1 (79)	54.1 (1374)	10.0 (254)	230 (105)
PVM4-260D	7.5 (5.59)	1.15	3	190/380	213TCZ	1.25 (32)	1.25 (32)	27.09 (688)	37.1 (941)	13.9 (353)	8.1 (206)	3.1 (79)	54.1 (1374)	10.3 (262)	227 (103)

*Measurements represent the largest number possible for each model using standard efficiency motors.

AURORA PVMX4 SERIES

DIMENSIONS AND SPECIFICATIONS

316 SS CONSTRUCTION

0.33 – 1.5 HP (.246 – 1.12 kW) PUMPS

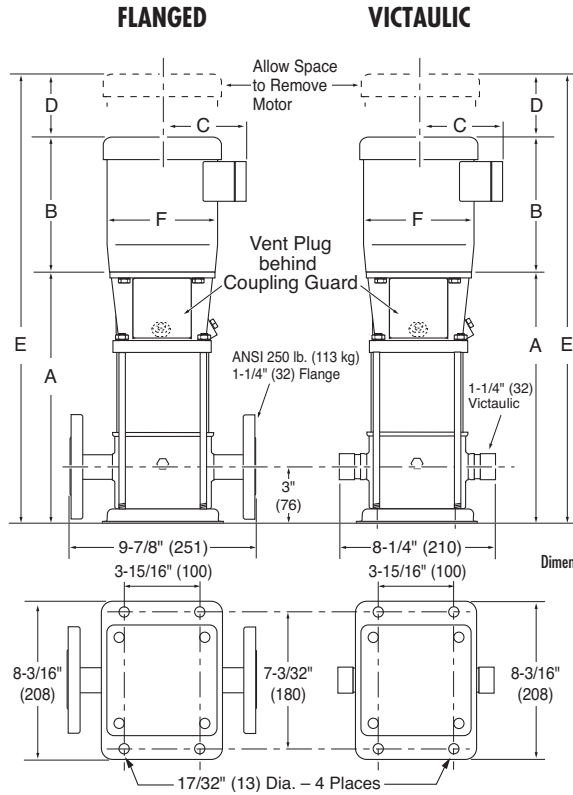
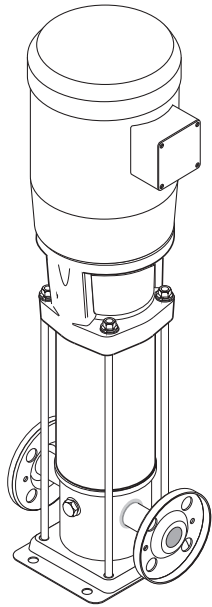

TECHNICAL INFORMATION	
MINIMUM PUMPING RATES	2.5 GPM (9.5 LPM)
FLOW RANGE	2.5 – 33 GPM (9.5 – 124.9 LPM)
MIN. SUCTION PIPE SIZES	1-1/4" (32 mm) Nominal Diameter, Schedule 40 Pipe
MAX. WORKING PRESSURE	360 PSI (25 Bar)
MAX. AMBIENT TEMP.	104° F (40° C)
LIQUID TEMP. RANGE	+5° F to +250° F (-15° C to 121° C)
MOTOR OPTIONS	TEFC or ODP
CONSTRUCTION MATERIALS	See Page 16

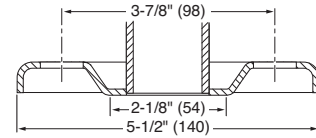

Model Number	HP (kW)	Motor S.F.	ph	Volts	Frame Size	Disc. Size in Inches (mm)	Suction Size in Inches (mm)	Sleeve in Inches (mm)	Dimensions in Inches (mm)*						TEFC Wt. Lbs. (kg)
									A	B	C	D	E	F	
PVM(1/X)4-20/1D	0.33 (.246)	1.25	1	110/220	56CZ	1.25 (32)	1.25 (32)	1.57 (40)	11.7 (297)	9.3 (236)	4.5 (114)	2.0 (51)	23.0 (584)	6.0 (152)	50 (23)
PVM(1/X)4-20/1D	0.33 (.246)	1.25	3	190/380	56CZ	1.25 (32)	1.25 (32)	1.57 (40)	11.7 (297)	9.3 (236)	5.2 (132)	2.0 (51)	23.0 (584)	6.2 (157)	61 (28)
PVM(1/X)4-20D	0.5 (.373)	1.25	1	110/220	56CZ	1.25 (32)	1.25 (32)	1.57 (40)	11.7 (297)	9.3 (236)	4.5 (114)	2.0 (51)	23.0 (584)	6.0 (152)	60 (27)
PVM(1/X)4-20D	0.5 (.373)	1.25	3	190/380	56CZ	1.25 (32)	1.25 (32)	1.57 (40)	11.7 (297)	9.3 (236)	5.2 (132)	2.0 (51)	23.0 (584)	6.2 (157)	60 (27)
PVM(1/X)4-30D	0.75 (.559)	1.25	1	110/220	56CZ	1.25 (32)	1.25 (32)	2.64 (67)	12.8 (325)	10.1 (257)	5.3 (135)	2.0 (51)	24.9 (632)	7.2 (183)	67 (30)
PVM(1/X)4-30D	0.75 (.559)	1.25	3	190/380	56CZ	1.25 (32)	1.25 (32)	2.64 (67)	12.8 (325)	9.3 (236)	5.2 (132)	2.0 (51)	24.1 (612)	6.2 (157)	66 (30)
PVM(1/X)4-40D	1 (.746)	1.25	1	110/220	56CZ	1.25 (32)	1.25 (32)	3.70 (94)	13.9 (353)	10.1 (257)	5.7 (145)	2.0 (51)	26.0 (660)	7.2 (183)	78 (35)
PVM(1/X)4-40D	1 (.746)	1.25	3	190/380	56CZ	1.25 (32)	1.25 (32)	3.70 (94)	13.9 (353)	10.1 (257)	5.7 (145)	2.0 (51)	26.0 (660)	7.2 (183)	74 (34)
PVM(1/X)4-50D	1.5 (1.12)	1.25	1	110/220	56CZ	1.25 (32)	1.25 (32)	4.76 (121)	14.9 (378)	10.1 (257)	5.7 (145)	2.0 (51)	27.0 (686)	7.2 (183)	86 (39)
PVM(1/X)4-50D	1.5 (1.12)	1.25	3	190/380	56CZ	1.25 (32)	1.25 (32)	4.76 (121)	14.9 (378)	10.1 (257)	5.7 (145)	2.0 (51)	27.0 (686)	7.2 (183)	82 (37)

*Measurements represent the largest number possible for each model using standard efficiency motors.

DIMENSIONS AND SPECIFICATIONS

316 SS CONSTRUCTION

2 – 7.5 HP (1.49 – 5.59 kW) PUMPS

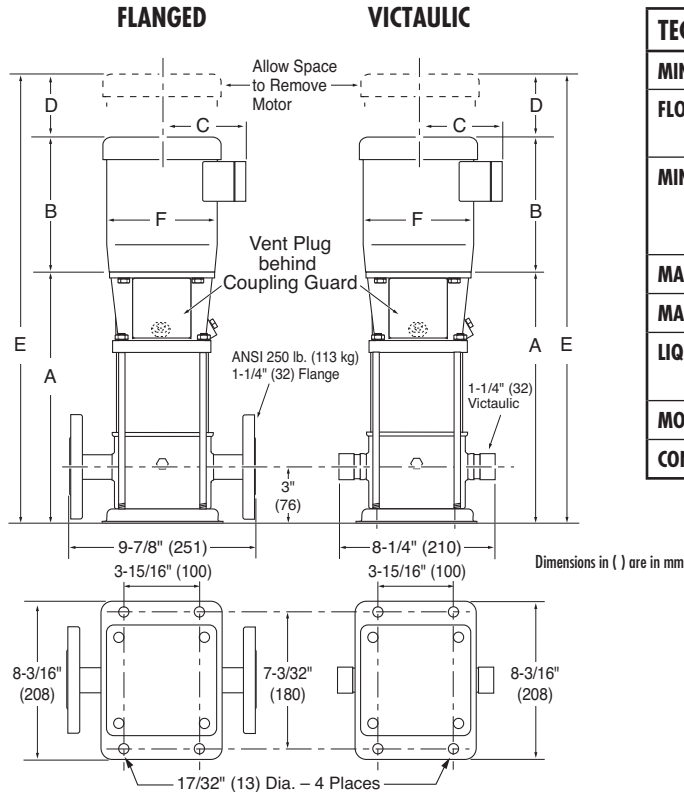
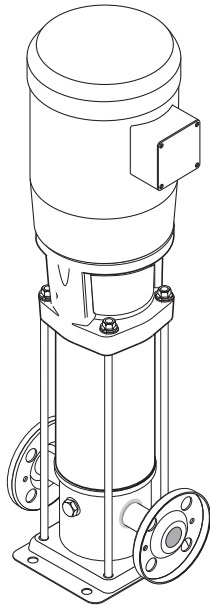

TECHNICAL INFORMATION	
MINIMUM PUMPING RATES	2.5 GPM (9.5 LPM)
FLOW RANGE	2.5 – 33 GPM (9.5 – 124.9 LPM)
MIN. SUCTION PIPE SIZES	1-1/4" (32 mm) Nominal Diameter, Schedule 40 Pipe
MAX. WORKING PRESSURE	360 PSI (25 Bar)
MAX. AMBIENT TEMP.	104° F (40° C)
LIQUID TEMP. RANGE	+5° F to +250° F (-15° C to 121° C)
MOTOR OPTIONS	TEFC or ODP
CONSTRUCTION MATERIALS	See Page 16

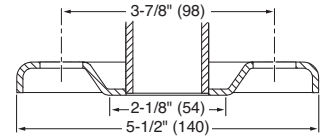

Model Number	HP (kW)	Motor S.F.	ph	Volts	Frame Size	Disc. Size in Inches (mm)	Suction Size in Inches (mm)	Sleeve in Inches (mm)	Dimensions in Inches (mm)*						TEFC Wt. Lbs. (kg)
									A	B	C	D	E	F	
PVM(I/X)4-60D	2 (1.49)	1.4	1	110/220	182TCZ	1.25 (32)	1.25 (32)	5.83 (148)	16.0 (406)	13.9 (353)	7.9 (201)	2.6 (66)	32.5 (826)	10.0 (254)	127 (57)
PVM(I/X)4-60D	2 (1.49)	1.4	3	190/380	182TCZ	1.25 (32)	1.25 (32)	5.83 (148)	16.0 (406)	12.6 (320)	6.9 (175)	2.6 (66)	31.2 (793)	8.6 (218)	107 (48)
PVM(I/X)4-80/7D	2 (1.49)	1.4	1	110/220	182TCZ	1.25 (32)	1.25 (32)	7.95 (202)	18.1 (460)	13.9 (353)	7.9 (201)	2.6 (66)	34.6 (879)	10.0 (254)	129 (59)
PVM(I/X)4-80/7D	2 (1.49)	1.4	3	190/380	182TCZ	1.25 (32)	1.25 (32)	7.95 (202)	18.1 (460)	12.6 (320)	6.9 (175)	2.6 (66)	33.3 (846)	8.6 (218)	109 (49)
PVM(I/X)4-80D	2 (1.49)	1.4	1	110/220	182TCZ	1.25 (32)	1.25 (32)	7.95 (202)	18.1 (460)	13.9 (353)	7.9 (201)	2.6 (66)	34.6 (879)	10.0 (254)	129 (59)
PVM(I/X)4-80D	2 (1.49)	1.4	3	190/380	182TCZ	1.25 (32)	1.25 (32)	7.95 (202)	18.1 (460)	12.6 (320)	6.9 (175)	2.6 (66)	33.3 (846)	8.6 (218)	109 (49)
PVM(I/X)4-90D	3 (2.24)	1.4	1	110/220	213TCZ	1.25 (32)	1.25 (32)	9.02 (229)	19.2 (487)	13.9 (353)	7.9 (201)	2.6 (66)	35.7 (907)	10.0 (254)	151 (69)
PVM(I/X)4-90D	3 (2.24)	1.4	3	190/380	184TCZ	1.25 (32)	1.25 (32)	9.02 (229)	19.2 (487)	12.6 (320)	6.9 (175)	2.6 (66)	34.4 (874)	8.6 (218)	125 (57)
PVM(I/X)4-100D	3 (2.24)	1.4	1	110/220	213TCZ	1.25 (32)	1.25 (32)	10.08 (256)	20.2 (514)	13.9 (353)	7.9 (201)	2.6 (66)	36.7 (932)	10.0 (254)	153 (69)
PVM(I/X)4-100D	3 (2.24)	1.4	3	190/380	184TCZ	1.25 (32)	1.25 (32)	10.08 (256)	20.2 (514)	12.6 (320)	6.9 (175)	2.6 (66)	35.4 (899)	8.6 (218)	127 (57)
PVM(I/X)4-110D	3 (2.24)	1.4	1	110/220	213TCZ	1.25 (32)	1.25 (32)	11.14 (283)	21.3 (541)	13.9 (353)	7.9 (201)	2.6 (66)	37.8 (960)	10.0 (254)	154 (70)
PVM(I/X)4-110D	3 (2.24)	1.4	3	190/380	184TCZ	1.25 (32)	1.25 (32)	11.14 (283)	21.3 (541)	12.6 (320)	6.9 (175)	2.6 (66)	36.5 (927)	8.6 (218)	128 (58)
PVM(I/X)4-120D	3 (2.24)	1.4	1	110/220	213TCZ	1.25 (32)	1.25 (32)	12.20 (310)	22.4 (568)	13.9 (353)	7.9 (201)	2.6 (66)	38.9 (988)	10.0 (254)	155 (70)
PVM(I/X)4-120D	3 (2.24)	1.4	3	190/380	184TCZ	1.25 (32)	1.25 (32)	12.20 (310)	22.4 (568)	12.6 (320)	6.9 (175)	2.6 (66)	37.6 (955)	8.6 (218)	129 (59)
PVM(I/X)4-130D	3 (2.24)	1.4	1	110/220	213TCZ	1.25 (32)	1.25 (32)	13.27 (337)	23.4 (595)	13.9 (353)	7.9 (201)	2.6 (66)	39.9 (1013)	10.0 (254)	156 (71)
PVM(I/X)4-130D	3 (2.24)	1.4	3	190/380	184TCZ	1.25 (32)	1.25 (32)	13.27 (337)	23.4 (595)	12.6 (320)	6.9 (175)	2.6 (66)	38.6 (980)	8.6 (218)	130 (59)
PVM(I/X)4-140D	3 (2.24)	1.4	1	110/220	213TCZ	1.25 (32)	1.25 (32)	14.33 (364)	24.5 (622)	13.9 (353)	7.9 (201)	2.6 (66)	41.0 (1041)	10.0 (254)	158 (72)
PVM(I/X)4-140D	3 (2.24)	1.4	3	190/380	184TCZ	1.25 (32)	1.25 (32)	14.33 (364)	24.5 (622)	12.6 (320)	6.9 (175)	2.6 (66)	39.7 (1008)	8.6 (218)	132 (60)
PVM(I/X)4-150D	5 (3.73)	1.4	1	110/220	213TCZ	1.25 (32)	1.25 (32)	15.39 (391)	25.5 (649)	13.9 (353)	7.9 (201)	2.6 (66)	42.0 (1067)	10.0 (254)	173 (78)
PVM(I/X)4-150D	5 (3.73)	1.4	3	190/380	213TCZ	1.25 (32)	1.25 (32)	15.39 (391)	25.5 (649)	13.9 (353)	8.1 (206)	2.6 (66)	42.0 (1067)	10.3 (262)	177 (80)
PVM(I/X)4-160D	5 (3.73)	1.4	1	110/220	213TCZ	1.25 (32)	1.25 (32)	16.46 (418)	26.6 (676)	13.9 (353)	7.9 (201)	2.6 (66)	43.1 (1095)	10.0 (254)	174 (79)
PVM(I/X)4-160D	5 (3.73)	1.4	3	190/380	213TCZ	1.25 (32)	1.25 (32)	16.46 (418)	26.6 (676)	13.9 (353)	8.1 (206)	2.6 (66)	43.1 (1095)	10.3 (262)	178 (81)
PVM(I/X)4-190D	5 (3.73)	1.4	1	110/220	213TCZ	1.25 (32)	1.25 (32)	19.65 (499)	29.8 (757)	13.9 (353)	7.9 (201)	2.6 (66)	46.3 (1176)	10.0 (254)	178 (81)
PVM(I/X)4-190D	5 (3.73)	1.4	3	190/380	213TCZ	1.25 (32)	1.25 (32)	19.65 (499)	29.8 (757)	13.9 (353)	8.1 (206)	2.6 (66)	46.3 (1176)	10.3 (262)	182 (83)
PVM(I/X)4-220D	5 (3.73)	1.4	1	110/220	213TCZ	1.25 (32)	1.25 (32)	22.83 (580)	33.0 (838)	13.9 (353)	7.9 (201)	2.6 (66)	49.5 (1257)	10.0 (254)	182 (82)
PVM(I/X)4-220D	5 (3.73)	1.4	3	190/380	213TCZ	1.25 (32)	1.25 (32)	22.83 (580)	33.0 (838)	13.9 (353)	8.1 (206)	2.6 (66)	49.5 (1257)	10.3 (262)	186 (84)
PVM(I/X)4-240D	7.5 (5.59)	1.15	1	110/220	213TCZ	1.25 (32)	1.25 (32)	24.96 (634)	35.1 (892)	13.9 (353)	7.9 (201)	3.1 (79)	52.1 (1323)	10.0 (254)	214 (97)
PVM(I/X)4-240D	7.5 (5.59)	1.15	3	190/380	213TCZ	1.25 (32)	1.25 (32)	24.96 (634)	35.1 (892)	13.9 (353)	8.1 (206)	3.1 (79)	52.1 (1323)	10.3 (262)	211 (96)
PVM(I/X)4-260D	7.5 (5.59)	1.15	1	110/220	213TCZ	1.25 (32)	1.25 (32)	27.09 (688)	37.2 (946)	13.9 (353)	7.9 (201)	3.1 (79)	54.2 (1377)	10.0 (254)	217 (98)
PVM(I/X)4-260D	7.5 (5.59)	1.15	3	190/380	213TCZ	1.25 (32)	1.25 (32)	27.09 (688)	37.2 (946)	13.9 (353)	8.1 (206)	3.1 (79)	54.2 (1377)	10.3 (262)	214 (97)

*Measurements represent the largest number possible for each model using standard efficiency motors.

CONSTRUCTION MATERIALS

Description	Cast Iron	316 Stainless Steel	Optional Accessories
Shaft	AISI 316 SS	AISI 316 SS	
Impellers, Diffuser Chambers, Pump Sleeve, Suction Interconnector and Shaft Seal Parts	AISI 304 SS	AISI 316 SS	
Suction / Discharge	Class 30 Cast Iron	316 SS	
Motor Bracket	Class 30 Cast Iron	Class 30 CI or 316 SS	
Motor Couplings	Class 30 Cast Iron	Class 30 Cast Iron	
Intermediate Chamber	Aluminum Oxide	Aluminum Oxide	
Bearings	Ceramic	Ceramic	
Bearing Ring	Tungsten Carbide	Tungsten Carbide	
O-Rings	EPDM	EPDM	Viton® or Buna
Wear Rings	Teflon®	Teflon®	
Sleeve O-Rings	EPDM	EPDM	Viton® or Buna
Shaft Spacers	AISI 316 SS	AISI 316 SS	
Top Spring	AISI 316 SS	AISI 316 SS	
Coupling Guard	AISI 302 SS	AISI 302 SS	
Staybolts, Nuts & Washers	Zinc Plated Steel	Zinc Plated Steel	
Mechanical Seal (High Pressure)			
Stationary Face	Carbon Graphite	Carbon Graphite	
Rotating Face	Tungsten Carbide	Tungsten Carbide	
O-Rings	EPDM	EPDM	Viton® or Buna
Upper and Lower Drivers	AISI 316 SS	AISI 316 SS	
Spring	AISI 316 SS	AISI 316 SS	

PERFORMANCE CURVES

NOMINAL RPM: 2875

BASED ON FRESH WATER @ 68° F (20° C)

MAXIMUM WORKING PRESSURE: 360 PSI (25 BAR)

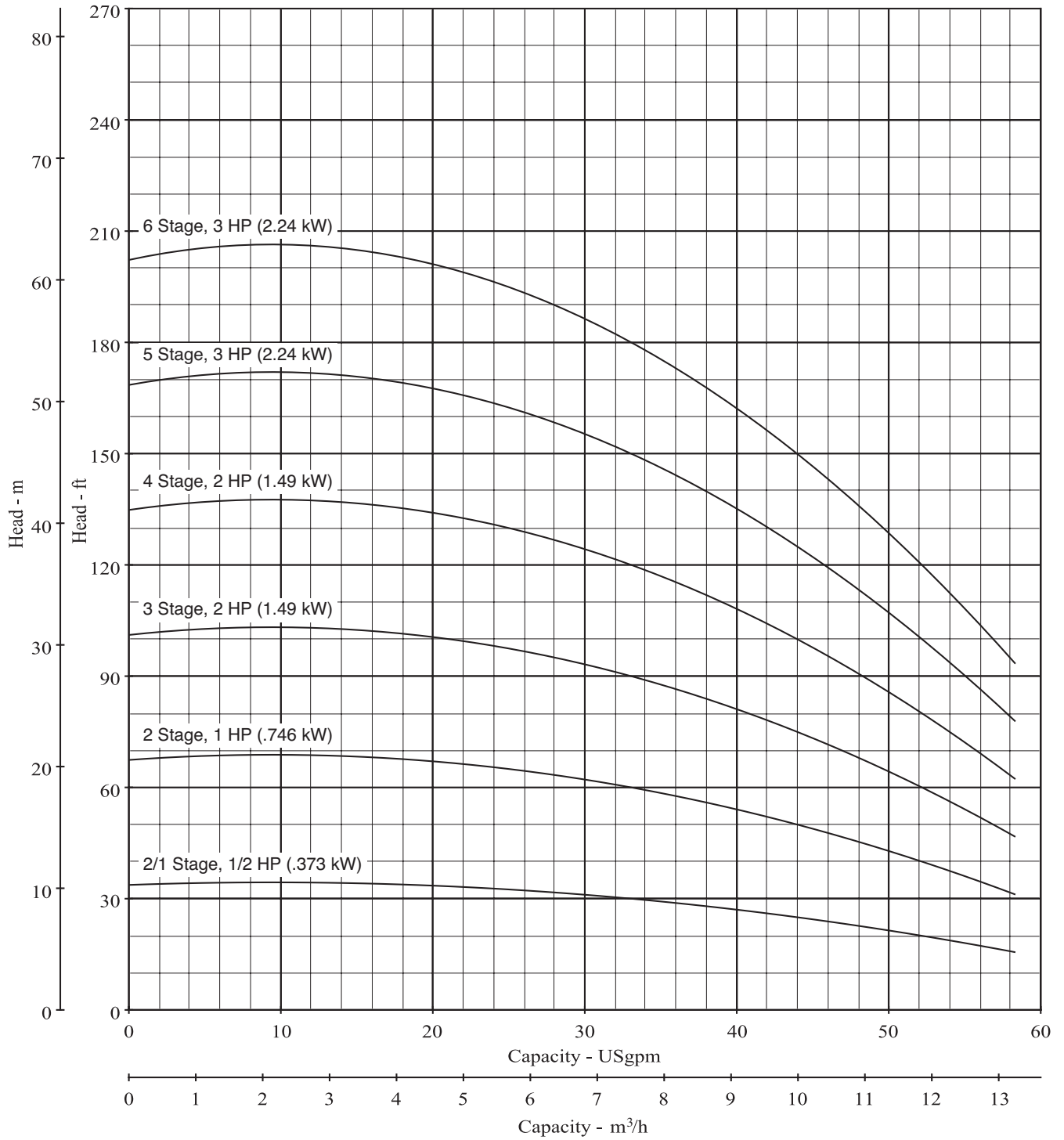

AURORA PVM(X)8 SERIES

PERFORMANCE CURVES

NOMINAL RPM: 2875

BASED ON FRESH WATER @ 68° F (20° C)

MAXIMUM WORKING PRESSURE: 360 PSI (25 BAR)

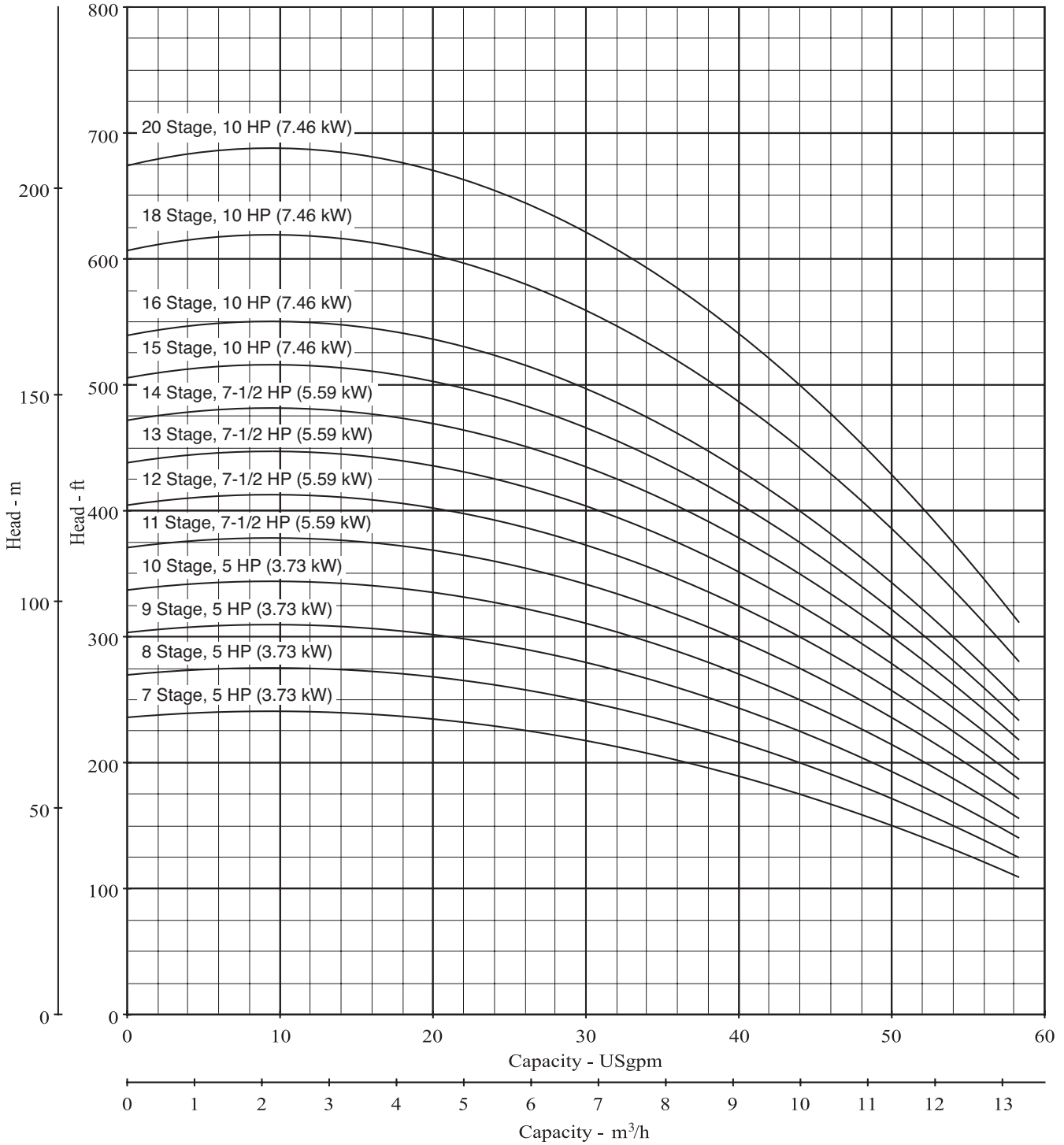

AURORA PVM(X)8 SERIES

SINGLE STAGE PERFORMANCE DATA

NOMINAL RPM: 2875

BASED ON FRESH WATER @ 68° F (20° C)

MAXIMUM WORKING PRESSURE: 360 PSI (25 BAR)

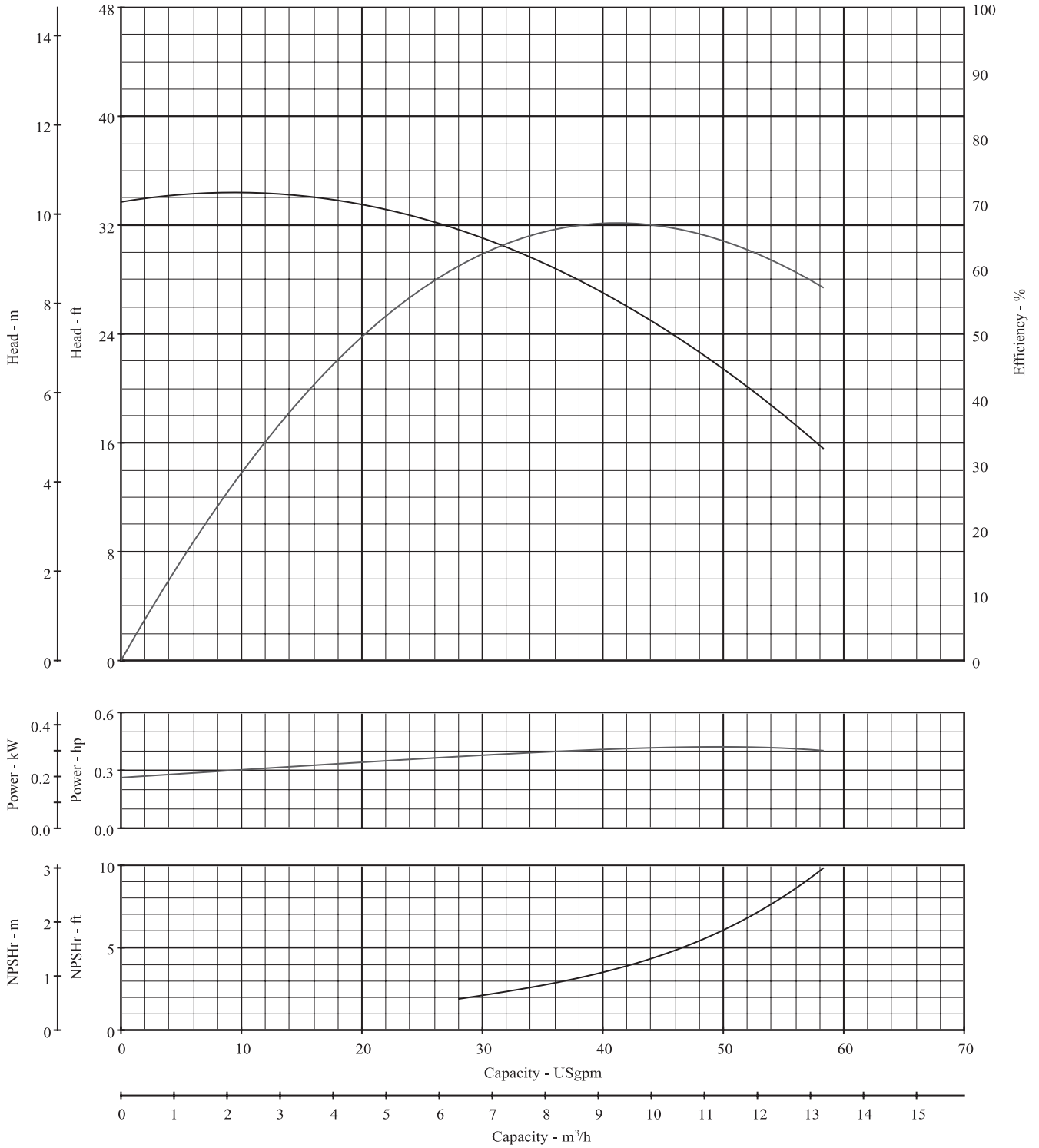

AURORA PVM8 SERIES

DIMENSIONS AND SPECIFICATIONS
 CAST IRON CONSTRUCTION
 0.5 – 5 HP (.373 – 3.73 kW) PUMPS

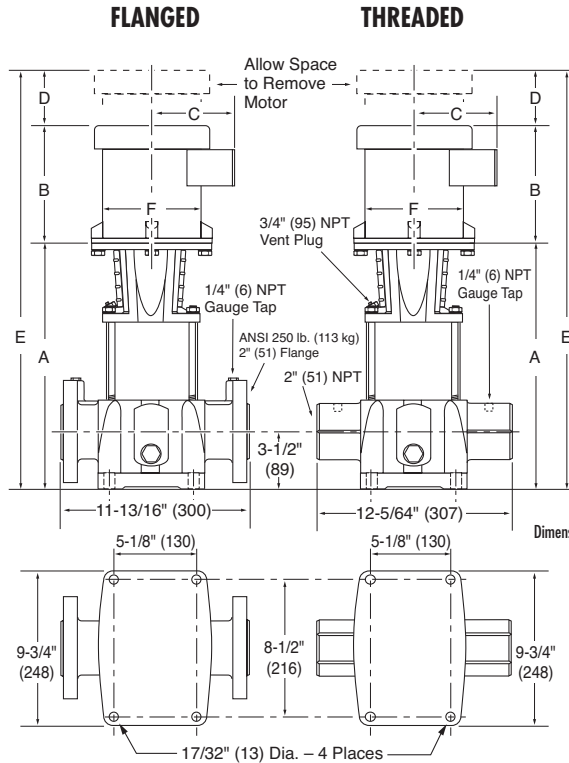
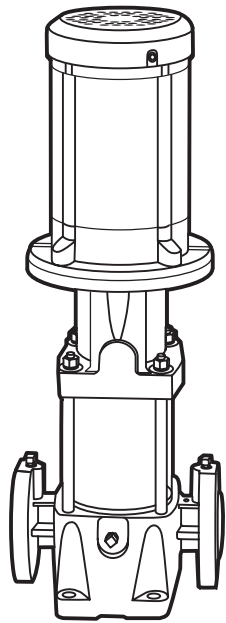

TECHNICAL INFORMATION	
MINIMUM PUMPING RATES	4.4 GPM (16.7 LPM)
FLOW RANGE	4.4 – 54 GPM (16.7 – 204 LPM)
MIN. SUCTION PIPE SIZES	2" (51 mm) Nominal Diameter, Schedule 40 Pipe
MAX. WORKING PRESSURE	360 PSI (25 Bar)
MAX. AMBIENT TEMP.	104° F (40° C)
LIQUID TEMP. RANGE	+5° F to +250° F (-15° C to 121° C)
MOTOR OPTIONS	TEFC or ODP
CONSTRUCTION MATERIALS	See Page 29

2" (51) ANSI. 250 lb. (113 kg) 8-Bolt Flange

Dimensions in () are in mm.

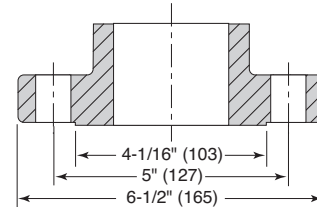

Model Number	HP (kW)	Motor S.F.	ph	Volts	Frame Size	Disc. Size in Inches (mm)	Suction Size in Inches (mm)	Sleeve in Inches (mm)	Dimensions in Inches (mm)*						TEFC Wt. Lbs. (kg)
									A	B	C	D	E	F	
PVM8-20/1D	0.5 (.373)	1.25	1	110/220	56CZ	2 (51)	2 (51)	3.35 (85)	14.1 (358)	9.3 (236)	4.5 (114)	2.0 (51)	25.4 (645)	6.0 (152)	93 (42)
PVM8-20/1D	0.5 (.373)	1.25	3	190/380	56CZ	2 (51)	2 (51)	3.35 (85)	14.1 (358)	9.3 (236)	4.5 (114)	2.0 (51)	25.4 (645)	6.0 (152)	93 (42)
PVM8-20D	1 (.746)	1.25	1	110/220	56CZ	2 (51)	2 (51)	3.35 (85)	15.2 (386)	10.1 (257)	5.7 (145)	2.0 (51)	27.3 (693)	7.2 (183)	111 (50)
PVM8-20D	1 (.746)	1.25	3	190/380	56CZ	2 (51)	2 (51)	3.35 (85)	15.2 (386)	10.1 (257)	5.7 (145)	2.0 (51)	27.3 (693)	7.2 (183)	107 (49)
PVM8-30D	2 (1.49)	1.4	1	110/220	182TCZ	2 (51)	2 (51)	4.53 (115)	16.4 (417)	13.9 (353)	7.9 (201)	2.6 (66)	32.9 (836)	10.0 (254)	169 (77)
PVM8-30D	2 (1.49)	1.4	3	190/380	182TCZ	2 (51)	2 (51)	4.53 (115)	16.4 (417)	12.6 (320)	6.9 (175)	2.6 (66)	31.6 (803)	8.6 (218)	149 (68)
PVM8-40D	2 (1.49)	1.4	1	110/220	182TCZ	2 (51)	2 (51)	5.71 (145)	17.6 (447)	13.9 (353)	7.9 (201)	2.6 (66)	34.1 (866)	10.0 (254)	171 (77)
PVM8-40D	2 (1.49)	1.4	3	190/380	182TCZ	2 (51)	2 (51)	5.71 (145)	17.6 (447)	12.6 (320)	6.9 (175)	2.6 (66)	32.8 (833)	8.6 (218)	151 (68)
PVM8-50D	3 (2.24)	1.4	1	110/220	213TCZ	2 (51)	2 (51)	6.89 (175)	18.8 (478)	13.9 (353)	7.9 (201)	2.6 (66)	35.3 (897)	10.0 (254)	193 (88)
PVM8-50D	3 (2.24)	1.4	3	190/380	184TCZ	2 (51)	2 (51)	6.89 (175)	18.8 (478)	12.6 (320)	6.9 (175)	2.6 (66)	34.0 (864)	8.6 (218)	167 (76)
PVM8-60D	3 (2.24)	1.4	1	110/220	213TCZ	2 (51)	2 (51)	8.07 (205)	20.0 (508)	13.9 (353)	7.9 (201)	2.6 (66)	36.5 (927)	10.0 (254)	195 (88)
PVM8-60D	3 (2.24)	1.4	3	190/380	184TCZ	2 (51)	2 (51)	8.07 (205)	20.0 (508)	12.6 (320)	6.9 (175)	2.6 (66)	35.2 (894)	8.6 (218)	169 (77)
PVM8-70D	5 (3.73)	1.4	1	110/220	213TCZ	2 (51)	2 (51)	9.25 (235)	21.1 (536)	13.9 (353)	7.9 (201)	2.6 (66)	37.6 (955)	10.0 (254)	210 (95)
PVM8-70D	5 (3.73)	1.4	3	190/380	213TCZ	2 (51)	2 (51)	9.25 (235)	21.1 (536)	13.9 (353)	8.1 (206)	2.6 (66)	37.6 (955)	10.3 (262)	214 (97)

*Measurements represent the largest number possible for each model using standard efficiency motors.

DIMENSIONS AND SPECIFICATIONS CAST IRON CONSTRUCTION 5 – 10 HP (3.73 – 7.46 kW) PUMPS

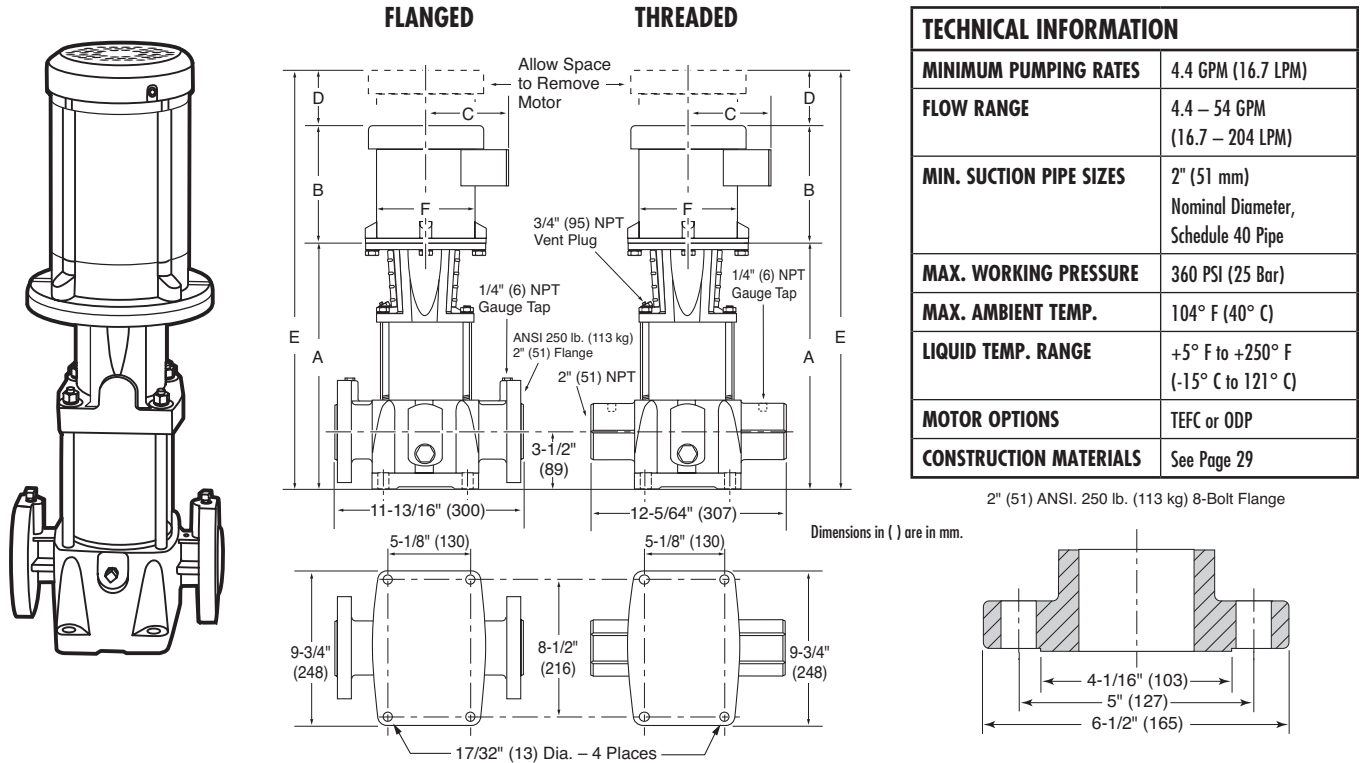

Model Number	HP (kW)	Motor S.F.	ph	Volts	Frame Size	Disc. Size in Inches (mm)	Suction Size in Inches (mm)	Sleeve in Inches (mm)	Dimensions in Inches (mm)*						TEFC Wt. Lbs. (kg)
									A	B	C	D	E	F	
PVM8-80D	5 (3.73)	1.4	1	110/220	213TCZ	2 (51)	2 (51)	10.43 (265)	22.3 (566)	13.9 (353)	7.9 (201)	2.6 (66)	38.8 (986)	10.0 (254)	212 (96)
PVM8-80D	5 (3.73)	1.4	3	190/380	213TCZ	2 (51)	2 (51)	10.43 (265)	22.3 (566)	13.9 (353)	8.1 (206)	2.6 (66)	38.8 (986)	10.3 (262)	216 (98)
PVM8-90D	5 (3.73)	1.4	1	110/220	213TCZ	2 (51)	2 (51)	11.61 (295)	23.5 (597)	13.9 (353)	7.9 (201)	2.6 (66)	40.0 (1016)	10.0 (254)	213 (97)
PVM8-90D	5 (3.73)	1.4	3	190/380	213TCZ	2 (51)	2 (51)	11.61 (295)	23.5 (597)	13.9 (353)	8.1 (206)	2.6 (66)	40.0 (1016)	10.3 (262)	217 (99)
PVM8-100D	5 (3.73)	1.4	1	110/220	213TCZ	2 (51)	2 (51)	12.80 (325)	24.7 (627)	13.9 (353)	7.9 (201)	2.6 (66)	41.2 (1046)	10.0 (254)	215 (97)
PVM8-100D	5 (3.73)	1.4	3	190/380	213TCZ	2 (51)	2 (51)	12.80 (325)	24.7 (627)	13.9 (353)	8.1 (206)	2.6 (66)	41.2 (1046)	10.3 (262)	219 (99)
PVM8-110D	7.5 (5.59)	1.15	1	110/220	215TCZ	2 (51)	2 (51)	13.98 (355)	25.9 (658)	13.9 (353)	7.9 (201)	3.1 (79)	42.9 (1090)	10.0 (254)	248 (113)
PVM8-110D	7.5 (5.59)	1.15	3	190/380	215TCZ	2 (51)	2 (51)	13.98 (355)	25.9 (658)	14.2 (361)	8.1 (206)	3.1 (79)	43.2 (1097)	10.3 (262)	245 (111)
PVM8-120D	7.5 (5.59)	1.15	1	110/220	215TCZ	2 (51)	2 (51)	15.16 (385)	27.0 (686)	13.9 (353)	7.9 (201)	3.1 (79)	44 (1118)	10.0 (254)	250 (113)
PVM8-120D	7.5 (5.59)	1.15	3	190/380	215TCZ	2 (51)	2 (51)	15.16 (385)	27.0 (686)	14.2 (361)	8.1 (206)	3.1 (79)	44.3 (1125)	10.3 (262)	247 (112)
PVM8-130D	7.5 (5.59)	1.15	1	110/220	215TCZ	2 (51)	2 (51)	16.34 (415)	28.2 (716)	13.9 (353)	7.9 (201)	3.1 (79)	45.2 (1148)	10.0 (254)	251 (114)
PVM8-130D	7.5 (5.59)	1.15	3	190/380	215TCZ	2 (51)	2 (51)	16.34 (415)	28.2 (716)	14.2 (361)	8.1 (206)	3.1 (79)	45.5 (1156)	10.3 (262)	248 (113)
PVM8-140D	7.5 (5.59)	1.15	1	110/220	215TCZ	2 (51)	2 (51)	17.52 (445)	29.4 (747)	13.9 (353)	7.9 (201)	3.1 (79)	46.4 (1179)	10.0 (254)	253 (115)
PVM8-140D	7.5 (5.59)	1.15	3	190/380	215TCZ	2 (51)	2 (51)	17.52 (445)	29.4 (747)	14.2 (361)	8.1 (206)	3.1 (79)	46.7 (1186)	10.3 (262)	250 (113)
PVM8-150D	10 (7.46)	1.15	3	190/380	215TCZ	2 (51)	2 (51)	18.70 (475)	31.1 (790)	20 (508)	9.5 (241)	4.0 (102)	56.3 (1430)	12.9 (328)	342 (155)
PVM8-160D	10 (7.46)	1.15	3	190/380	215TCZ	2 (51)	2 (51)	19.88 (505)	32.3 (820)	20 (508)	9.5 (241)	4.0 (102)	56.3 (1430)	12.9 (328)	342 (155)
PVM8-180D	10 (7.46)	1.15	3	190/380	215TCZ	2 (51)	2 (51)	22.24 (565)	34.6 (879)	20 (508)	9.5 (241)	4.0 (102)	58.6 (1488)	12.9 (328)	345 (156)
PVM8-200D	10 (7.46)	1.15	3	190/380	215TCZ	2 (51)	2 (51)	24.61 (625)	37.0 (940)	20 (508)	9.5 (241)	4.0 (102)	61.0 (1549)	12.9 (328)	348 (158)

*Measurements represent the largest number possible for each model using standard efficiency motors.

AURORA PVMX8 SERIES

DIMENSIONS AND SPECIFICATIONS

316 SS CONSTRUCTION

0.5 – 5 HP (.373 – 3.73 kW) PUMPS

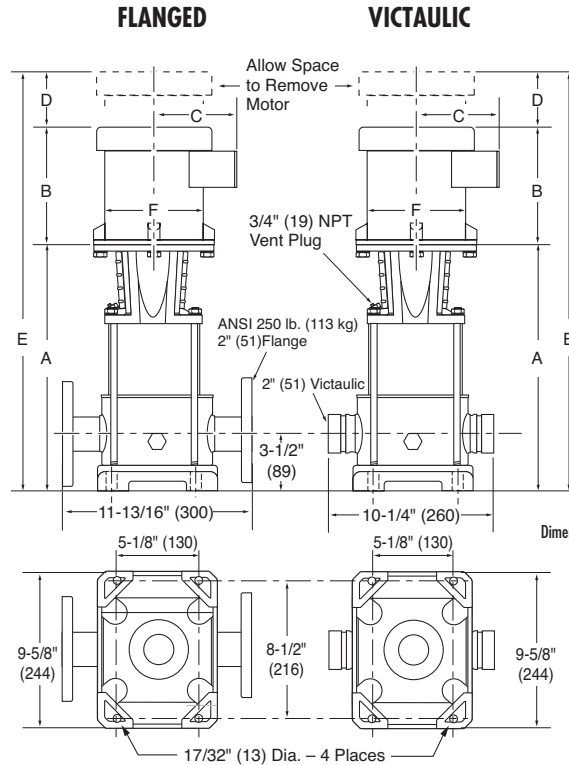
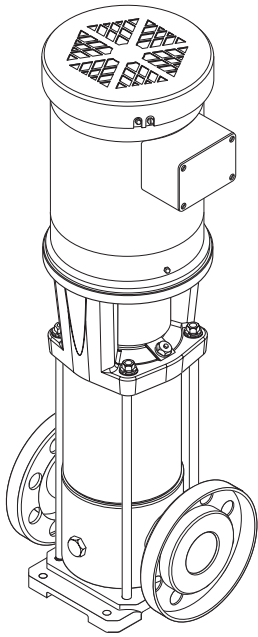

TECHNICAL INFORMATION	
MINIMUM PUMPING RATES	4.4 GPM (16.7 LPM)
FLOW RANGE	4.4 – 54 GPM (16.7 – 204 LPM)
MIN. SUCTION PIPE SIZES	2" (51 mm) Nominal Diameter, Schedule 40 Pipe
MAX. WORKING PRESSURE	360 PSI (25 Bar)
MAX. AMBIENT TEMP.	104° F (40° C)
LIQUID TEMP. RANGE	+5° F to +250° F (-15° C to 121° C)
MOTOR OPTIONS	TEFC or ODP
CONSTRUCTION MATERIALS	See Page 29

Dimensions in () are in mm.

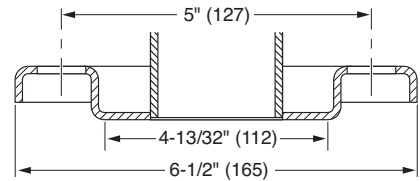

Model Number	HP (kW)	Motor S.F.	ph	Volts	Frame Size	Disc. Size in Inches (mm)	Suction Size in Inches (mm)	Sleeve in Inches (mm)	Dimensions in Inches (mm)*						TEFC Wt. Lbs. (kg)
									A	B	C	D	E	F	
PVM(I/X)8-20/1D	0.5 (.373)	1.25	1	110/220	56CZ	2 (51)	2 (51)	3.35 (85)	14.1 (358)	9.3 (236)	4.5 (114)	2.0 (51)	25.4 (645)	6.0 (152)	71 (32)
PVM(I/X)8-20/1D	0.5 (.373)	1.25	3	190/380	56CZ	2 (51)	2 (51)	3.35 (85)	14.1 (358)	9.3 (236)	4.5 (114)	2.0 (51)	25.4 (645)	6.0 (152)	71 (32)
PVM(I/X)8-20D	1 (.746)	1.25	1	110/220	56CZ	2 (51)	2 (51)	3.35 (85)	15.2 (386)	10.1 (257)	5.7 (145)	2.0 (51)	27.3 (693)	7.2 (183)	88 (40)
PVM(I/X)8-20D	1 (.746)	1.25	3	190/380	56CZ	2 (51)	2 (51)	3.35 (85)	15.2 (386)	10.1 (257)	5.7 (145)	2.0 (51)	27.3 (693)	7.2 (183)	84 (38)
PVM(I/X)8-30D	2 (1.49)	1.4	1	110/220	182TCZ	2 (51)	2 (51)	4.53 (115)	16.4 (417)	13.9 (353)	7.9 (201)	2.6 (66)	32.9 (836)	10.0 (254)	147 (67)
PVM(I/X)8-30D	2 (1.49)	1.4	3	190/380	182TCZ	2 (51)	2 (51)	4.53 (115)	16.4 (417)	12.6 (320)	6.9 (175)	2.6 (66)	31.6 (803)	8.6 (218)	127 (58)
PVM(I/X)8-40D	2 (1.49)	1.4	1	110/220	182TCZ	2 (51)	2 (51)	5.71 (145)	17.6 (447)	13.9 (353)	7.9 (201)	2.6 (66)	34.1 (866)	10.0 (254)	148 (67)
PVM(I/X)8-40D	2 (1.49)	1.4	3	190/380	182TCZ	2 (51)	2 (51)	5.71 (145)	17.6 (447)	12.6 (320)	6.9 (175)	2.6 (66)	32.8 (833)	8.6 (218)	128 (58)
PVM(I/X)8-50D	3 (2.24)	1.4	1	110/220	213TCZ	2 (51)	2 (51)	6.89 (175)	18.8 (478)	13.9 (353)	7.9 (201)	2.6 (66)	35.3 (897)	10.0 (254)	171 (77)
PVM(I/X)8-50D	3 (2.24)	1.4	3	190/380	184TCZ	2 (51)	2 (51)	6.89 (175)	18.8 (478)	12.6 (320)	6.9 (175)	2.6 (66)	34.0 (864)	8.6 (218)	145 (66)
PVM(I/X)8-60D	3 (2.24)	1.4	1	110/220	213TCZ	2 (51)	2 (51)	8.07 (205)	20.0 (508)	13.9 (353)	7.9 (201)	2.6 (66)	36.5 (927)	10.0 (254)	172 (78)
PVM(I/X)8-60D	3 (2.24)	1.4	3	190/380	184TCZ	2 (51)	2 (51)	8.07 (205)	20.0 (508)	12.6 (320)	6.9 (175)	2.6 (66)	35.2 (894)	8.6 (218)	146 (66)
PVM(I/X)8-70D	5 (3.73)	1.4	1	110/220	213TCZ	2 (51)	2 (51)	9.25 (235)	21.1 (536)	13.9 (353)	7.9 (201)	2.6 (66)	37.6 (955)	10.0 (254)	188 (85)
PVM(I/X)8-70D	5 (3.73)	1.4	3	190/380	213TCZ	2 (51)	2 (51)	9.25 (235)	21.1 (536)	13.9 (353)	8.1 (206)	2.6 (66)	37.6 (955)	10.3 (262)	192 (87)

*Measurements represent the largest number possible for each model using standard efficiency motors.

DIMENSIONS AND SPECIFICATIONS

316 SS CONSTRUCTION

5 – 10 HP (3.73 – 7.46 kW) PUMPS

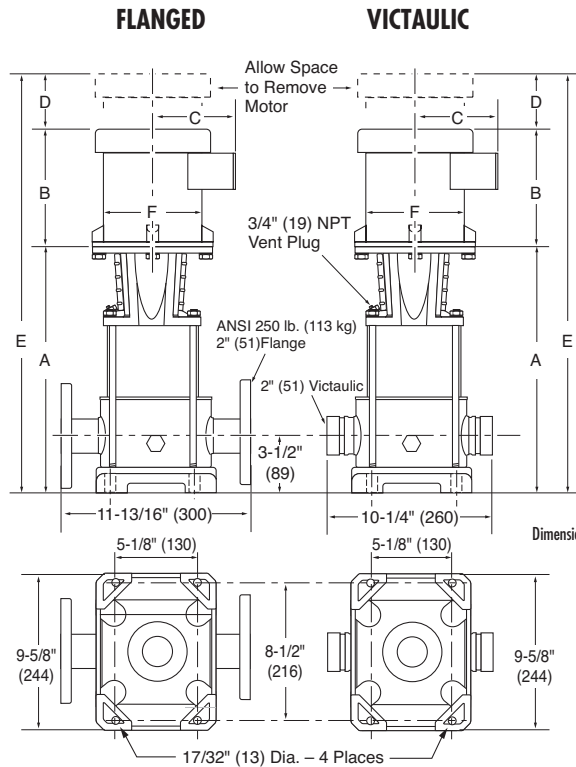
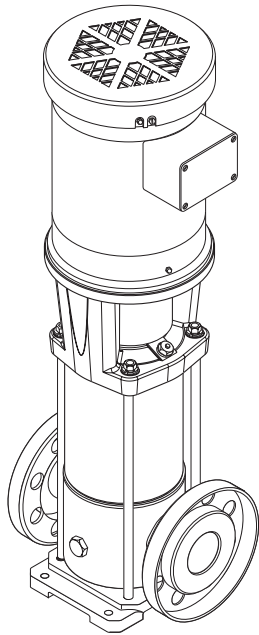

TECHNICAL INFORMATION	
MINIMUM PUMPING RATES	4.4 GPM (16.7 LPM)
FLOW RANGE	4.4 – 54 GPM (16.7 – 204 LPM)
MIN. SUCTION PIPE SIZES	2" (51 mm) Nominal Diameter, Schedule 40 Pipe
MAX. WORKING PRESSURE	360 PSI (25 Bar)
MAX. AMBIENT TEMP.	104° F (40° C)
LIQUID TEMP. RANGE	+5° F to +250° F (-15° C to 121° C)
MOTOR OPTIONS	TEFC or ODP
CONSTRUCTION MATERIALS	See Page 29

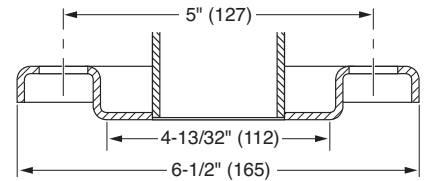

Model Number	HP (kW)	Motor S.F.	ph	Volts	Frame Size	Disc. Size in Inches (mm)	Suction Size in Inches (mm)	Sleeve in Inches (mm)	Dimensions in Inches (mm)*						TEFC Wt. Lbs. (kg)
									A	B	C	D	E	F	
PVM(I/X)8-80D	5 (3.73)	1.4	1	110/220	213TCZ	2 (51)	2 (51)	10.43 (265)	22.3 (566)	13.9 (353)	7.9 (201)	2.6 (66)	38.8 (986)	10.0 (254)	189 (86)
PVM(I/X)8-80D	5 (3.73)	1.4	3	190/380	213TCZ	2 (51)	2 (51)	10.43 (265)	22.3 (566)	13.9 (353)	8.1 (206)	2.6 (66)	38.8 (986)	10.3 (262)	193 (88)
PVM(I/X)8-90D	5 (3.73)	1.4	1	110/220	213TCZ	2 (51)	2 (51)	11.61 (295)	23.5 (597)	13.9 (353)	7.9 (201)	2.6 (66)	40.0 (1016)	10.0 (254)	191 (87)
PVM(I/X)8-90D	5 (3.73)	1.4	3	190/380	213TCZ	2 (51)	2 (51)	11.61 (295)	23.5 (597)	13.9 (353)	8.1 (206)	2.6 (66)	40.0 (1016)	10.3 (262)	195 (88)
PVM(I/X)8-100D	5 (3.73)	1.4	1	110/220	213TCZ	2 (51)	2 (51)	12.80 (325)	24.7 (627)	13.9 (353)	7.9 (201)	2.6 (66)	41.2 (1046)	10.0 (254)	192 (87)
PVM(I/X)8-100D	5 (3.73)	1.4	3	190/380	213TCZ	2 (51)	2 (51)	12.80 (325)	24.7 (627)	13.9 (353)	8.1 (206)	2.6 (66)	41.2 (1046)	10.3 (262)	196 (89)
PVM(I/X)8-110D	7.5 (5.59)	1.15	1	110/220	215TCZ	2 (51)	2 (51)	13.98 (355)	25.9 (658)	13.9 (353)	7.9 (201)	3.1 (79)	42.9 (1090)	10.0 (254)	226 (102)
PVM(I/X)8-110D	7.5 (5.59)	1.15	3	190/380	215TCZ	2 (51)	2 (51)	13.98 (355)	25.9 (658)	14.2 (361)	8.1 (206)	3.1 (79)	43.2 (1097)	10.3 (262)	223 (101)
PVM(I/X)8-120D	7.5 (5.59)	1.15	1	110/220	215TCZ	2 (51)	2 (51)	15.16 (385)	27.0 (686)	13.9 (353)	7.9 (201)	3.1 (79)	44.0 (1118)	10.0 (254)	227 (103)
PVM(I/X)8-120D	7.5 (5.59)	1.15	3	190/380	215TCZ	2 (51)	2 (51)	15.16 (385)	27.0 (686)	14.2 (361)	8.1 (206)	3.1 (79)	44.3 (1125)	10.3 (262)	224 (102)
PVM(I/X)8-130D	7.5 (5.59)	1.15	1	110/220	215TCZ	2 (51)	2 (51)	16.34 (415)	28.2 (716)	13.9 (353)	7.9 (201)	3.1 (79)	45.2 (1148)	10.0 (254)	229 (104)
PVM(I/X)8-130D	7.5 (5.59)	1.15	3	190/380	215TCZ	2 (51)	2 (51)	16.34 (415)	28.2 (716)	14.2 (361)	8.1 (206)	3.1 (79)	45.5 (1156)	10.3 (262)	226 (102)
PVM(I/X)8-140D	7.5 (5.59)	1.15	1	110/220	215TCZ	2 (51)	2 (51)	17.52 (445)	29.4 (747)	13.9 (353)	7.9 (201)	3.1 (79)	46.4 (1179)	10.0 (254)	230 (104)
PVM(I/X)8-140D	7.5 (5.59)	1.15	3	190/380	215TCZ	2 (51)	2 (51)	17.52 (445)	29.4 (747)	14.2 (361)	8.1 (206)	3.1 (79)	46.7 (1186)	10.3 (262)	227 (103)
PVM(I/X)8-150D	10 (7.46)	1.15	3	190/380	215TCZ	2 (51)	2 (51)	18.70 (475)	31.1 (790)	20.0 (508)	9.5 (241)	4.0 (102)	55.1 (1400)	12.9 (328)	318 (144)
PVM(I/X)8-160D	10 (7.46)	1.15	3	190/380	215TCZ	2 (51)	2 (51)	19.88 (505)	32.3 (820)	20.0 (508)	9.5 (241)	4.0 (102)	56.3 (1430)	12.9 (328)	319 (145)
PVM(I/X)8-180D	10 (7.46)	1.15	3	190/380	215TCZ	2 (51)	2 (51)	22.24 (565)	34.6 (879)	20.0 (508)	9.5 (241)	4.0 (102)	58.6 (1488)	12.9 (328)	322 (146)
PVM(I/X)8-200D	10 (7.46)	1.15	3	190/380	215TCZ	2 (51)	2 (51)	24.61 (625)	37.0 (940)	20.0 (508)	9.5 (241)	4.0 (102)	61.0 (1549)	12.9 (328)	325 (148)

*Measurements represent the largest number possible for each model using standard efficiency motors.

AURORA PVM(X)16 SERIES

PERFORMANCE CURVES

NOMINAL RPM: 2875

BASED ON FRESH WATER @ 68° F (20° C)

MAXIMUM WORKING PRESSURE: 360 PSI (25 BAR)

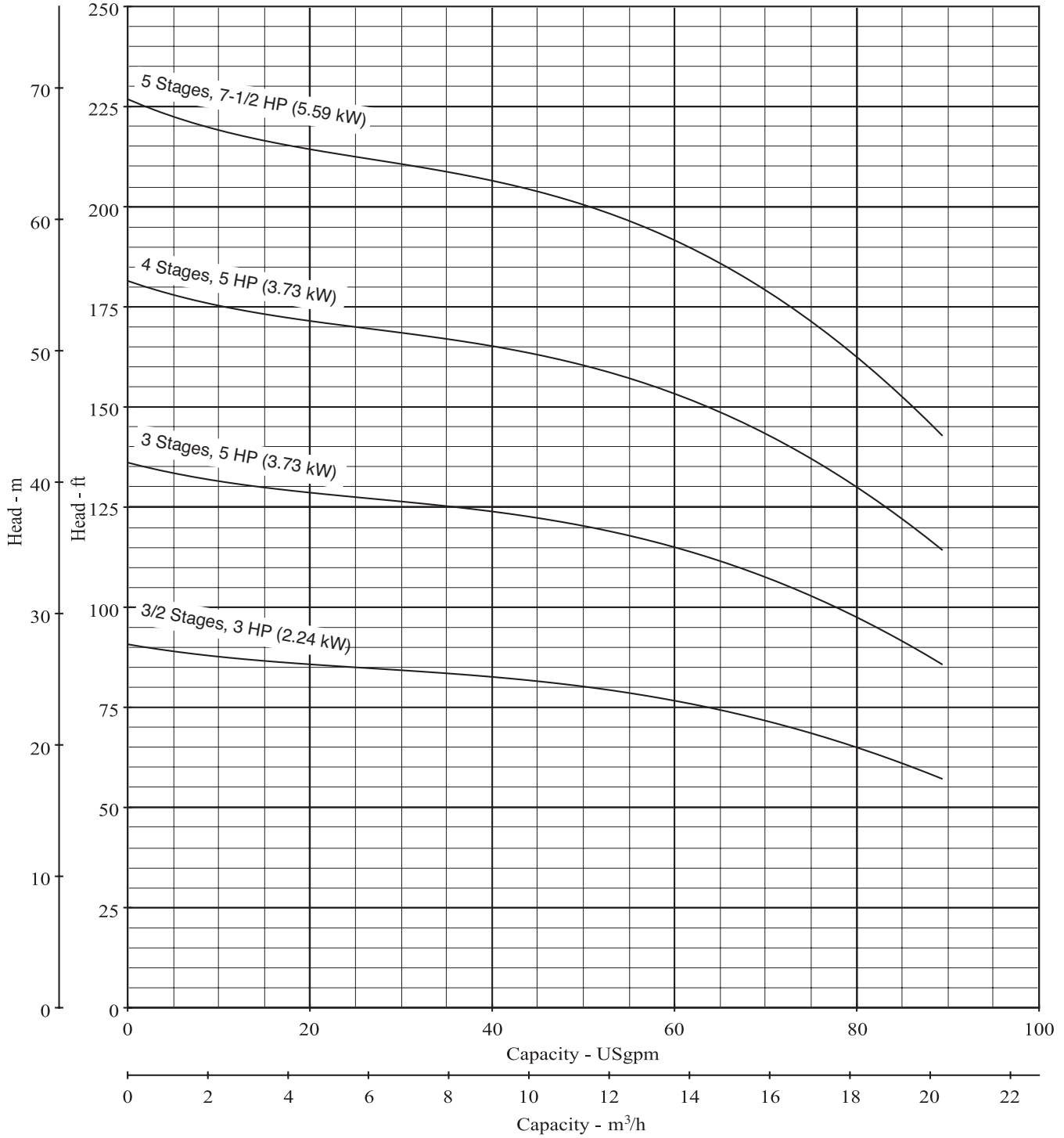

PERFORMANCE CURVES

NOMINAL RPM: 2875

BASED ON FRESH WATER @ 68° F (20° C)

MAXIMUM WORKING PRESSURE: 360 PSI (25 BAR)

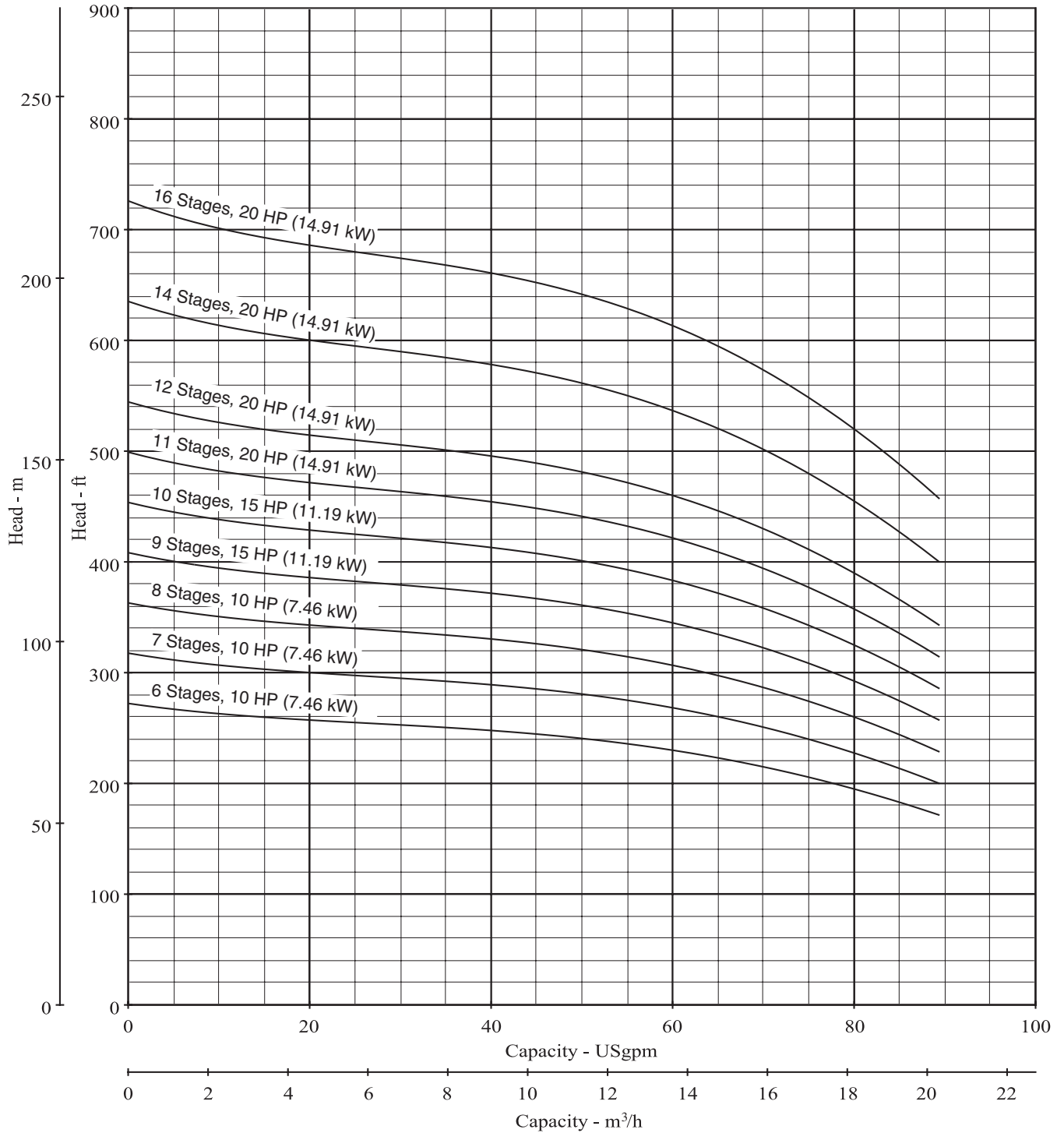

AURORA PVM(X)16 SERIES

SINGLE STAGE PERFORMANCE DATA

NOMINAL RPM: 2875

BASED ON FRESH WATER @ 68° F (20° C)

MAXIMUM WORKING PRESSURE: 360 PSI (25 BAR)

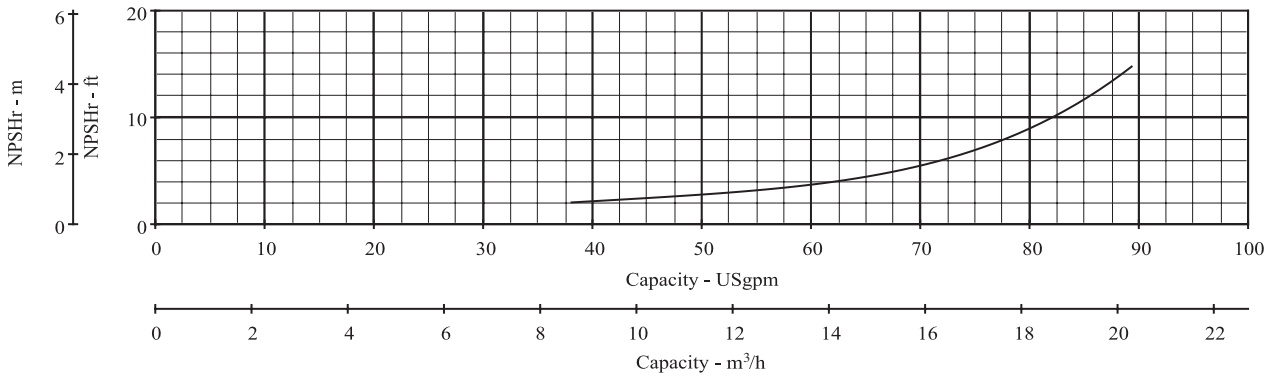
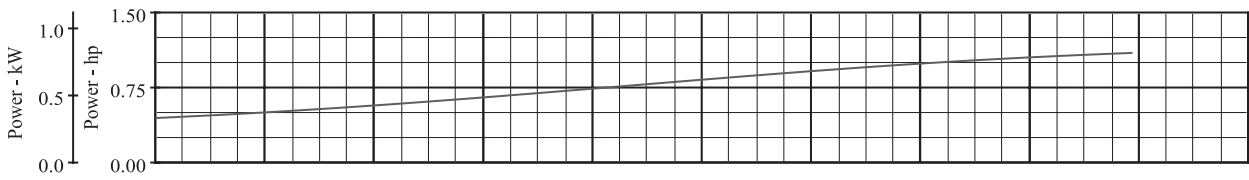
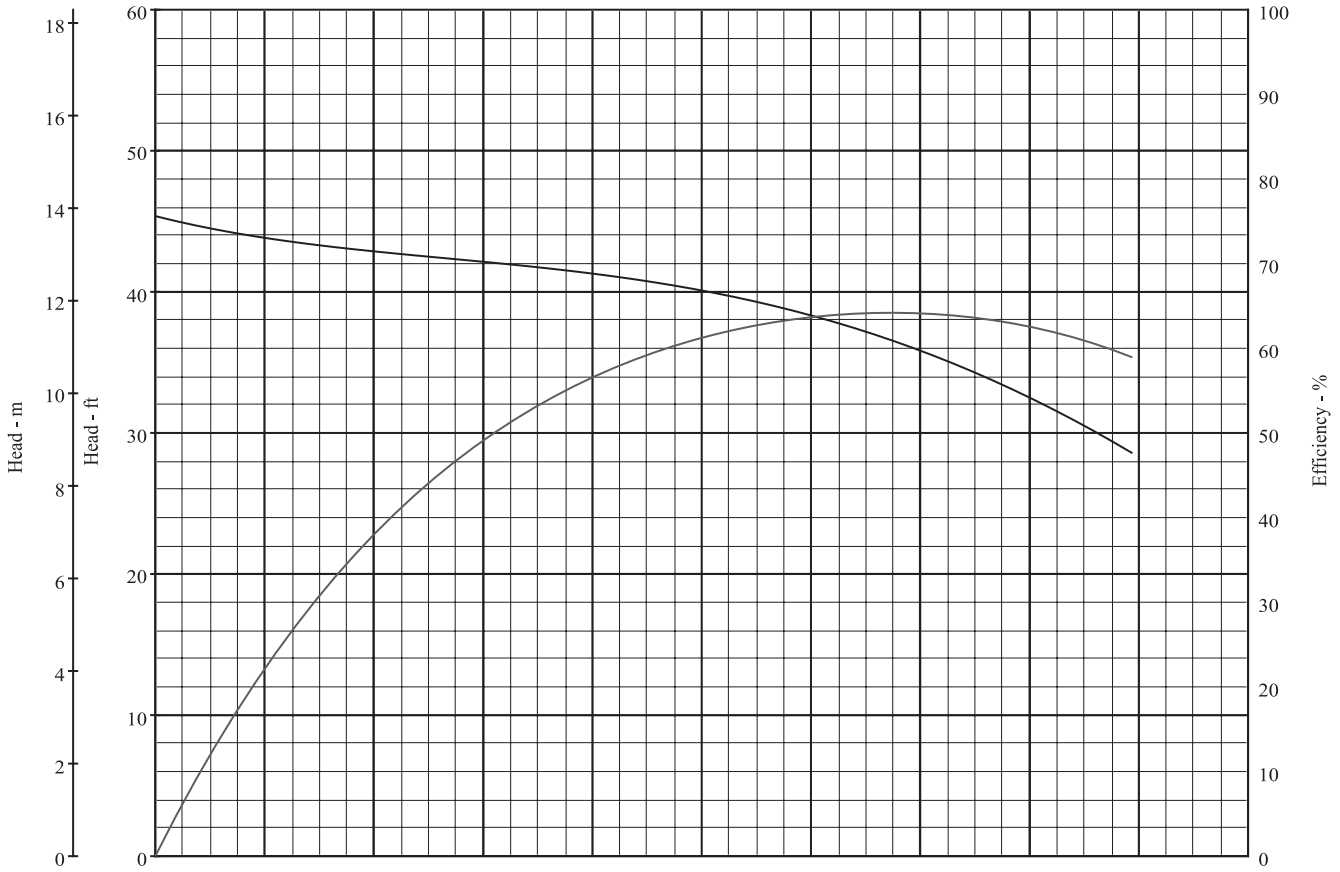

DIMENSIONS AND SPECIFICATIONS CAST IRON CONSTRUCTION 3 – 20 HP (2.24 – 14.91 kW) PUMPS

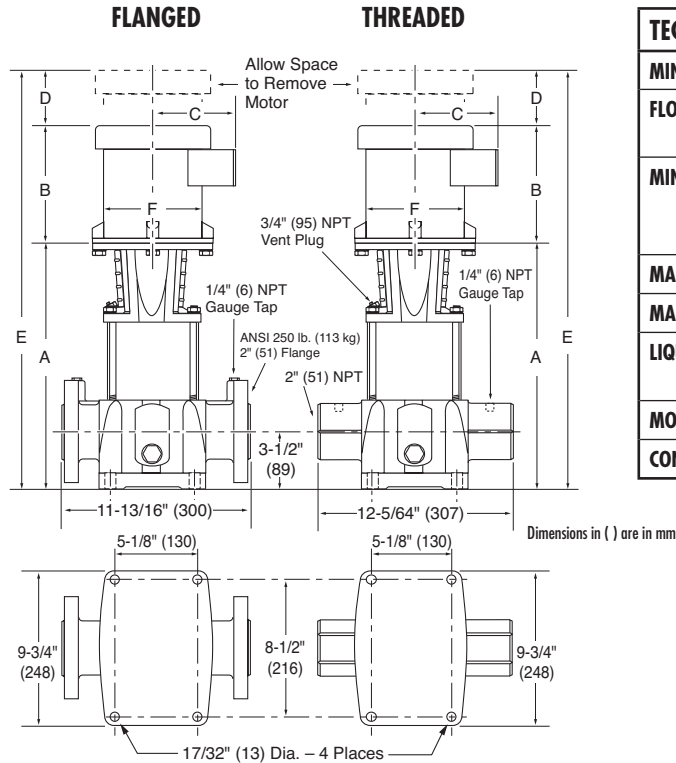
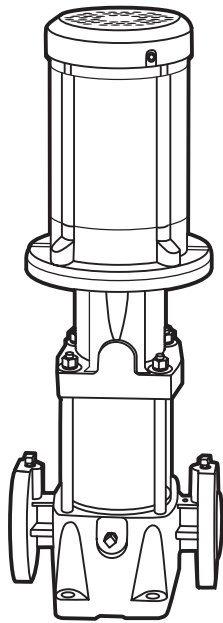

TECHNICAL INFORMATION	
MINIMUM PUMPING RATES	7.08 GPM (26.8 LPM)
FLOW RANGE	7.08 – 87.5 GPM (26.8 – 331.2 LPM)
MIN. SUCTION PIPE SIZES	2" (51 mm) Nominal Diameter, Schedule 40 Pipe
MAX. WORKING PRESSURE	360 PSI (25 Bar)
MAX. AMBIENT TEMP.	104° F (40° C)
LIQUID TEMP. RANGE	+5° F to +250° F (-15° C to 121° C)
MOTOR OPTIONS	TEFC or ODP
CONSTRUCTION MATERIALS	See Page 29

2" (51) ANSI, 250 lb. (113 kg) 8-Bolt Flange

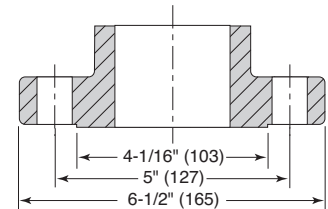

Model Number	HP (kW)	Motor S.F.	ph	Volts	Frame Size	Disc. Size in Inches (mm)	Suction Size in Inches (mm)	Sleeve in Inches (mm)	Dimensions in Inches (mm)*						TEFC Wt. Lbs. (kg)
									A	B	C	D	E	F	
PVM16-30/2D	3 (2.24)	1.4	1	110/220	213TCZ	2 (51)	2 (51)	5.71 (145)	15.8 (401)	13.9 (353)	7.9 (201)	2.6 (66)	32.3 (820)	10.0 (254)	189 (86)
PVM16-30/2D	3 (2.24)	1.4	3	190/380	184TCZ	2 (51)	2 (51)	5.71 (145)	15.8 (401)	12.6 (320)	6.9 (175)	2.6 (66)	31.0 (787)	8.6 (218)	163 (74)
PVM16-30D	5 (3.73)	1.4	1	110/220	213TCZ	2 (51)	2 (51)	5.71 (145)	17.6 (447)	13.9 (353)	7.9 (201)	2.6 (66)	34.1 (866)	10.0 (254)	204 (93)
PVM16-30D	5 (3.73)	1.4	3	190/380	213TCZ	2 (51)	2 (51)	5.71 (145)	17.6 (447)	13.9 (353)	8.1 (206)	2.6 (66)	34.1 (866)	10.3 (262)	208 (94)
PVM16-40D	5 (3.73)	1.4	1	110/220	213TCZ	2 (51)	2 (51)	7.48 (190)	19.4 (493)	13.9 (353)	7.9 (201)	2.6 (66)	35.9 (912)	10.0 (254)	206 (93)
PVM16-40D	5 (3.73)	1.4	3	190/380	213TCZ	2 (51)	2 (51)	7.48 (190)	19.4 (493)	13.9 (353)	8.1 (206)	2.6 (66)	35.9 (912)	10.3 (262)	210 (95)
PVM16-50D	7.5 (5.59)	1.15	1	110/220	215TCZ	2 (51)	2 (51)	9.25 (235)	21.1 (536)	13.9 (353)	7.9 (201)	3.1 (79)	38.1 (968)	10.0 (254)	239 (109)
PVM16-50D	7.5 (5.59)	1.15	3	190/380	215TCZ	2 (51)	2 (51)	9.25 (235)	21.1 (536)	14.2 (361)	8.1 (206)	3.1 (79)	38.4 (975)	10.3 (262)	236 (107)
PVM16-60D	10 (7.46)	1.15	3	190/380	254TCZ	2 (51)	2 (51)	11.02 (280)	23.4 (594)	20.0 (508)	9.5 (241)	4.0 (102)	47.4 (1204)	12.9 (328)	327 (148)
PVM16-70D	10 (7.46)	1.15	3	190/380	254TCZ	2 (51)	2 (51)	12.80 (325)	25.2 (640)	20.0 (508)	9.5 (241)	4.0 (102)	49.2 (1250)	12.9 (328)	328 (149)
PVM16-80D	10 (7.46)	1.15	3	190/380	254TCZ	2 (51)	2 (51)	14.57 (370)	27.0 (686)	20.0 (508)	9.5 (241)	4.0 (102)	51.0 (1295)	12.9 (328)	330 (150)
PVM16-90D	15 (11.19)	1.15	3	190/380	254TCZ	2 (51)	2 (51)	16.34 (415)	28.7 (729)	16.9 (429)	9.2 (234)	3.8 (97)	49.4 (1255)	11.5 (292)	374 (170)
PVM16-100D	15 (11.19)	1.15	3	190/380	254TCZ	2 (51)	2 (51)	18.11 (460)	30.5 (775)	16.9 (429)	9.2 (234)	3.8 (97)	51.2 (1300)	11.5 (292)	376 (170)
PVM16-110D	20 (14.91)	1.15	3	190/380	284TCZ	2 (51)	2 (51)	19.88 (505)	31.6 (803)	20.0 (508)	9.5 (241)	3.0 (76)	54.6 (1387)	13.3 (338)	393 (178)
PVM16-120D	20 (14.91)	1.15	3	190/380	284TCZ	2 (51)	2 (51)	21.65 (550)	33.4 (848)	20.0 (508)	9.5 (241)	3.0 (76)	56.4 (1433)	13.3 (338)	395 (179)
PVM16-130D	20 (14.91)	1.15	3	190/380	284TCZ	2 (51)	2 (51)	23.43 (595)	35.2 (894)	20.0 (508)	9.5 (241)	3.0 (76)	58.2 (1478)	13.3 (338)	396 (180)
PVM16-140D	20 (14.91)	1.15	3	190/380	284TCZ	2 (51)	2 (51)	25.20 (640)	36.9 (937)	20.0 (508)	9.5 (241)	3.0 (76)	59.9 (1521)	13.3 (338)	398 (180)
PVM16-160D	20 (14.91)	1.15	3	190/380	284TCZ	2 (51)	2 (51)	28.74 (730)	40.5 (1029)	20.0 (508)	9.5 (241)	3.0 (76)	63.5 (1613)	13.3 (338)	401 (182)

*Measurements represent the largest number possible for each model using standard efficiency motors.

AURORA PVMX16 SERIES

DIMENSIONS AND SPECIFICATIONS
 316 SS CONSTRUCTION
 3 – 20 HP (2.24 – 14.91 kW) PUMPS

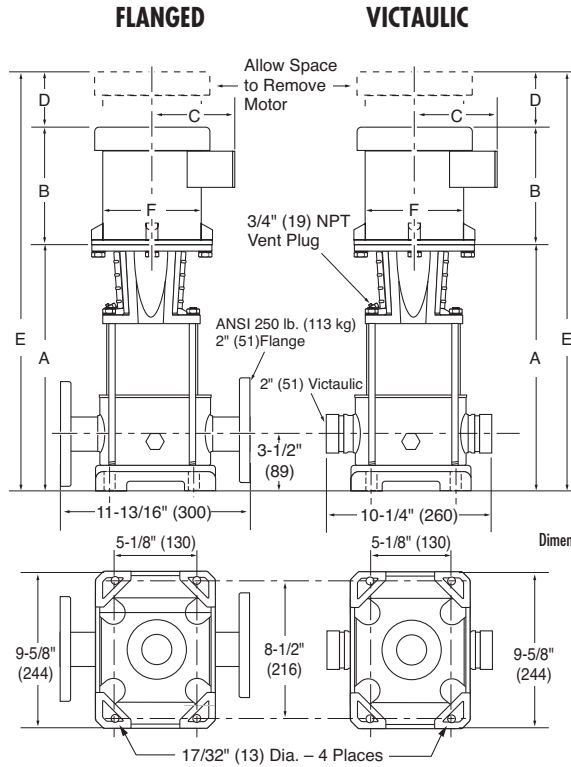
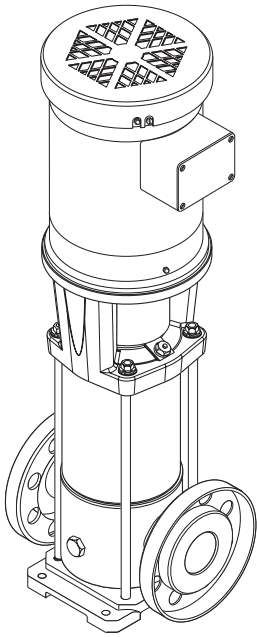

TECHNICAL INFORMATION	
MINIMUM PUMPING RATES	7.08 GPM (26.8 LPM)
FLOW RANGE	7.08 – 87.5 GPM (26.8 – 331.2 LPM)
MIN. SUCTION PIPE SIZES	2" (51 mm) Nominal Diameter, Schedule 40 Pipe
MAX. WORKING PRESSURE	360 PSI (25 Bar)
MAX. AMBIENT TEMP.	104° F (40° C)
LIQUID TEMP. RANGE	+5° F to +250° F (-15° C to 121° C)
MOTOR OPTIONS	TEFC or ODP
CONSTRUCTION MATERIALS	See Page 29

Dimensions in () are in mm.

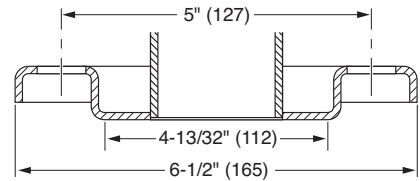

Model Number	HP (kW)	Motor S.F.	ph	Volts	Frame Size	Disc. Size in Inches (mm)	Suction Size in Inches (mm)	Sleeve in Inches (mm)	Dimensions in Inches (mm)*						TEFC Wt. Lbs. (kg)
									A	B	C	D	E	F	
PVM(I/X)16-30/2D	3 (2.24)	1.4	1	110/220	213TCZ	2 (51)	2 (51)	5.71 (145)	15.8 (401)	13.9 (353)	7.9 (201)	2.6 (66)	32.3 (820)	10.0 (254)	166 (75)
PVM(I/X)16-30/2D	3 (2.24)	1.4	3	190/380	184TCZ	2 (51)	2 (51)	5.71 (145)	15.8 (401)	12.6 (320)	6.9 (175)	2.6 (66)	31.0 (787)	8.6 (218)	140 (64)
PVM(I/X)16-30D	5 (3.73)	1.4	1	110/220	213TCZ	2 (51)	2 (51)	5.71 (145)	17.6 (447)	13.9 (353)	7.9 (201)	2.6 (66)	34.1 (866)	10.0 (254)	182 (82)
PVM(I/X)16-30D	5 (3.73)	1.4	3	190/380	213TCZ	2 (51)	2 (51)	5.71 (145)	17.6 (447)	13.9 (353)	8.1 (206)	2.6 (66)	34.1 (866)	10.3 (262)	186 (84)
PVM(I/X)16-40D	5 (3.73)	1.4	1	110/220	213TCZ	2 (51)	2 (51)	7.48 (190)	19.4 (493)	13.9 (353)	7.9 (201)	2.6 (66)	35.9 (912)	10.0 (254)	183 (83)
PVM(I/X)16-40D	5 (3.73)	1.4	3	190/380	213TCZ	2 (51)	2 (51)	7.48 (190)	19.4 (493)	13.9 (353)	8.1 (206)	2.6 (66)	35.9 (912)	10.3 (262)	187 (85)
PVM(I/X)16-50D	7.5 (5.59)	1.15	1	110/220	215TCZ	2 (51)	2 (51)	9.25 (235)	21.1 (536)	13.9 (353)	7.9 (201)	3.1 (79)	38.1 (968)	10.0 (254)	217 (98)
PVM(I/X)16-50D	7.5 (5.59)	1.15	3	190/380	215TCZ	2 (51)	2 (51)	9.25 (235)	21.1 (536)	14.2 (361)	8.1 (206)	3.1 (79)	38.4 (975)	10.3 (262)	214 (97)
PVM(I/X)16-60D	10 (7.46)	1.15	3	190/380	254TCZ	2 (51)	2 (51)	11.02 (280)	23.4 (594)	20.0 (508)	9.5 (241)	4.0 (102)	47.4 (1204)	12.9 (328)	304 (138)
PVM(I/X)16-70D	10 (7.46)	1.15	3	190/380	254TCZ	2 (51)	2 (51)	12.80 (325)	25.2 (640)	20.0 (508)	9.5 (241)	4.0 (102)	49.2 (1250)	12.9 (328)	306 (139)
PVM(I/X)16-80D	10 (7.46)	1.15	3	190/380	254TCZ	2 (51)	2 (51)	14.57 (370)	27.0 (686)	20.0 (508)	9.5 (241)	4.0 (102)	51.0 (1295)	12.9 (328)	307 (139)
PVM(I/X)16-90D	15 (11.19)	1.15	3	190/380	254TCZ	2 (51)	2 (51)	16.34 (415)	28.7 (729)	16.9 (429)	9.2 (234)	3.8 (97)	49.4 (1255)	11.5 (292)	352 (160)
PVM(I/X)16-100D	15 (11.19)	1.15	3	190/380	254TCZ	2 (51)	2 (51)	18.11 (460)	30.5 (775)	16.9 (429)	9.2 (234)	3.8 (97)	51.2 (1300)	11.5 (292)	353 (160)
PVM(I/X)16-110D	20 (14.91)	1.15	3	190/380	284TCZ	2 (51)	2 (51)	19.88 (505)	31.6 (803)	20.0 (508)	9.5 (241)	3.0 (76)	54.6 (1387)	13.3 (338)	371 (168)
PVM(I/X)16-120D	20 (14.91)	1.15	3	190/380	284TCZ	2 (51)	2 (51)	21.65 (550)	33.4 (848)	20.0 (508)	9.5 (241)	3.0 (76)	56.4 (1433)	13.3 (338)	372 (169)
PVM(I/X)16-130D	20 (14.91)	1.15	3	190/380	284TCZ	2 (51)	2 (51)	23.43 (595)	35.2 (894)	20.0 (508)	9.5 (241)	3.0 (76)	58.2 (1478)	13.3 (338)	374 (170)
PVM(I/X)16-140D	20 (14.91)	1.15	3	190/380	284TCZ	2 (51)	2 (51)	25.20 (640)	36.9 (937)	20.0 (508)	9.5 (241)	3.0 (76)	59.9 (1521)	13.3 (338)	375 (170)
PVM(I/X)16-160D	20 (14.91)	1.15	3	190/380	284TCZ	2 (51)	2 (51)	28.74 (730)	40.5 (1029)	20.0 (508)	9.5 (241)	3.0 (76)	63.5 (1613)	13.3 (338)	378 (172)

*Measurements represent the largest number possible for each model using standard efficiency motors.

CONSTRUCTION MATERIALS

Description	Cast Iron	316 Stainless Steel	Optional Accessories
Shaft	AISI 431 SS	AISI 316 SS	
Impellers, Diffuser Chambers, Pump Sleeve, Suction Interconnector and Shaft Seal Parts	AISI 304 SS	AISI 316 SS	
Suction / Discharge	Class 30 Cast Iron	316 SS	
Motor Bracket	Class 30 Cast Iron	Class 30 CI or 316 SS	
Motor Couplings	Class 30 Cast Iron	Class 30 Cast Iron	
Intermediate Chamber	Aluminum Oxide	Aluminum Oxide	
Bearings	Ceramic	Ceramic	
Bearing Ring	Tungsten Carbide	Tungsten Carbide	
O-Rings	EPDM	EPDM	Viton® or Buna-N
Wear Rings	Teflon®	Teflon®	
Sleeve O-Rings	EPDM	EPDM	Viton® or Buna-N
Shaft Spacers	AISI 316 SS	AISI 316 SS	
Top Spring	AISI 316 SS	AISI 316 SS	
Coupling Guard	AISI 302 SS	AISI 302 SS	
Staybolts, Nuts & Washers	Zinc Plated Steel	Zinc Plated Steel	
Mechanical Seal (High Pressure)			
Stationary Face	Carbon Graphite	Carbon Graphite	
Rotating Face	Tungsten Carbide	Tungsten Carbide	
O-Rings	EPDM	EPDM	Viton® or Buna-N
Upper and Lower Drivers	AISI 316 SS	AISI 316 SS	
Spring	AISI 316 SS	AISI 316 SS	

AURORA PVM32 SERIES

PERFORMANCE CURVES

NOMINAL RPM: 2875 (*2940)

BASED ON FRESH WATER @ 68° F (20° C)

MAXIMUM WORKING PRESSURE: 230 PSI (16 BAR)

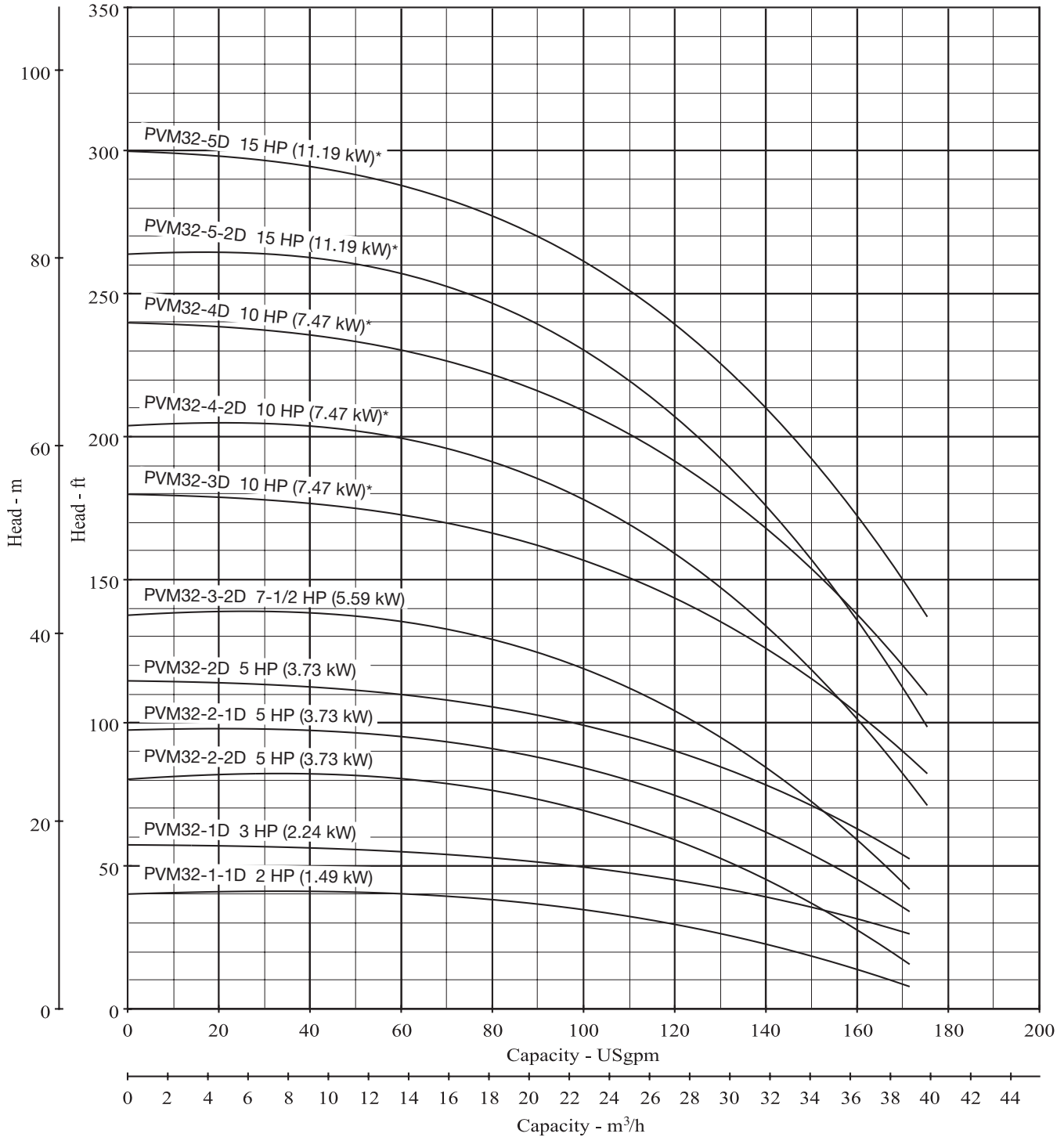

PERFORMANCE CURVES

NOMINAL RPM: 2875 (*2940)

BASED ON FRESH WATER @ 68° F (20° C)

MAXIMUM WORKING PRESSURE: 435 PSI (30 BAR)

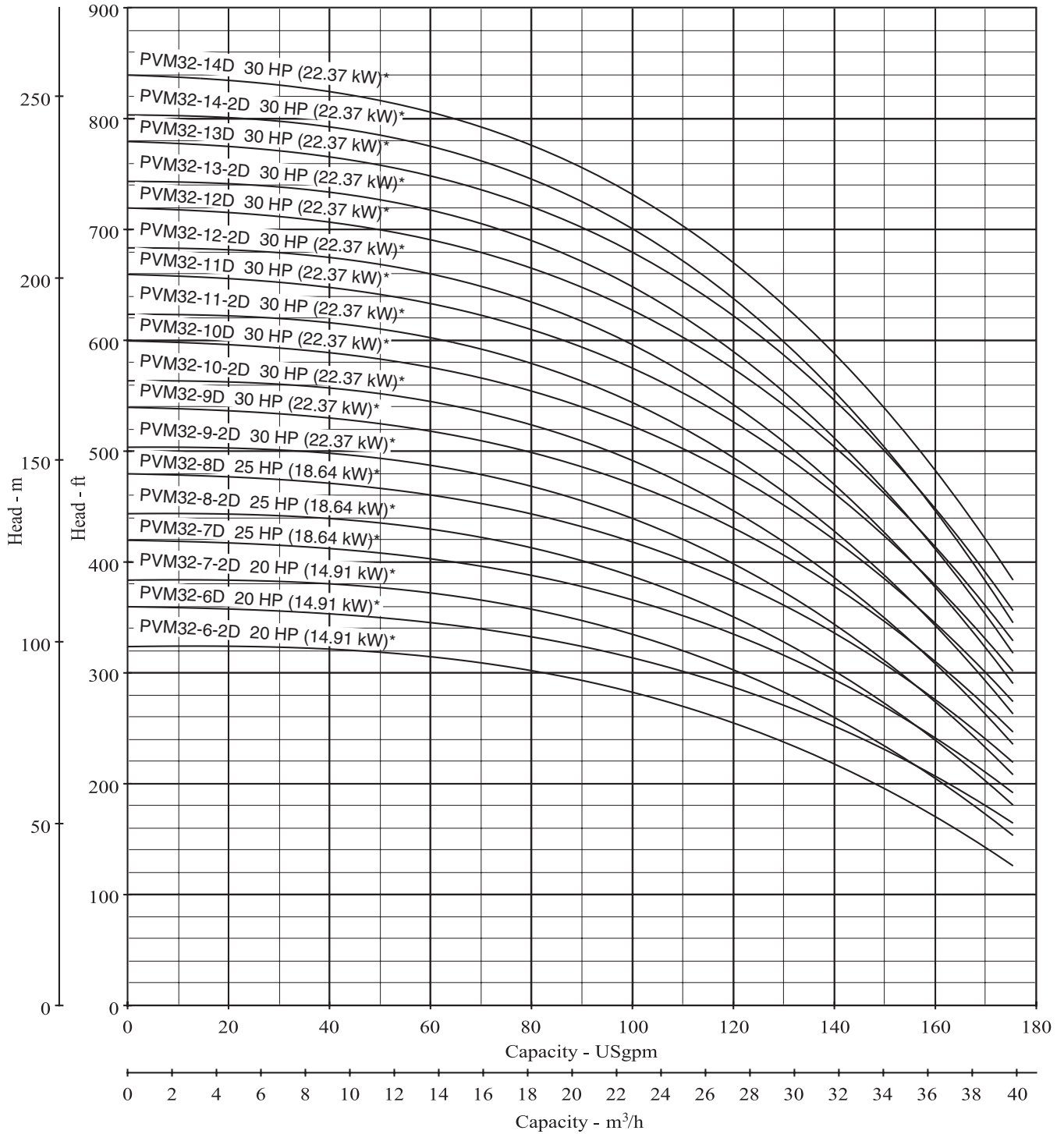

AURORA PVM32 SERIES

SINGLE STAGE PERFORMANCE DATA

NOMINAL RPM: 2940

BASED ON FRESH WATER @ 68° F (20° C)

MAXIMUM WORKING PRESSURE: 230 PSI (16 BAR)

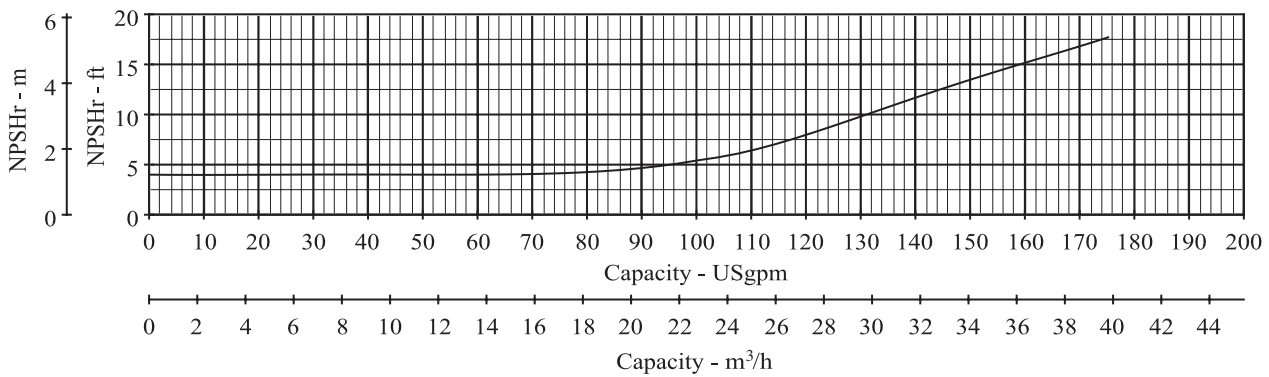
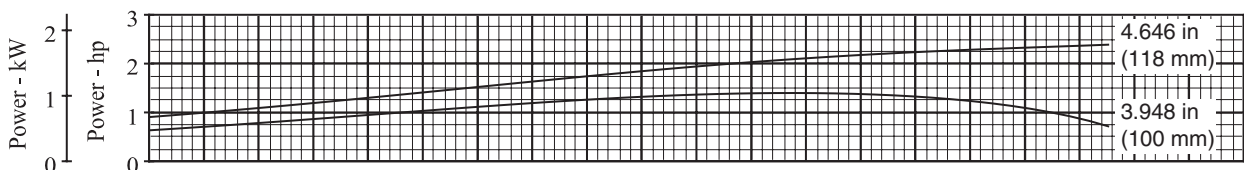
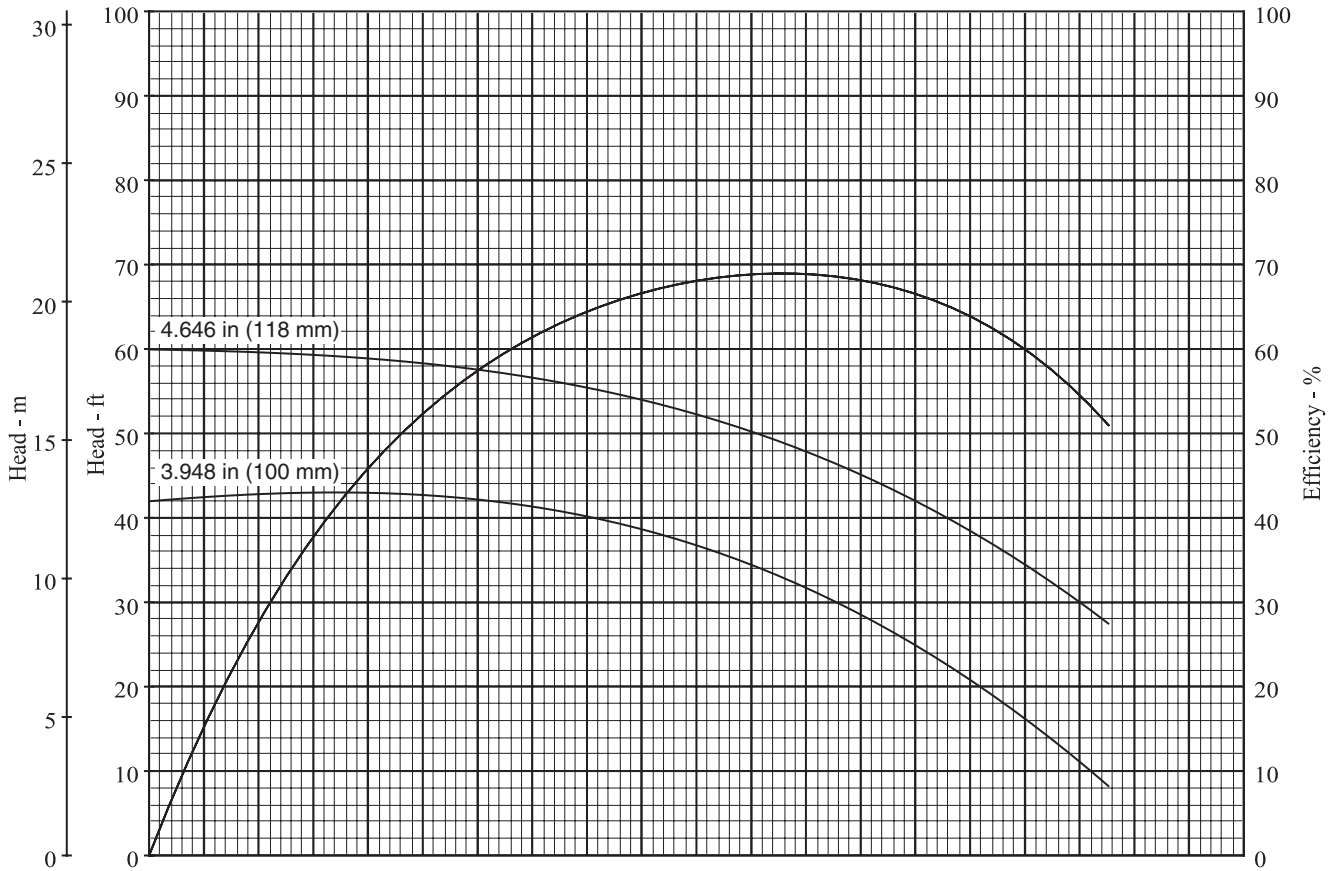

DIMENSIONS AND SPECIFICATIONS CAST IRON CONSTRUCTION

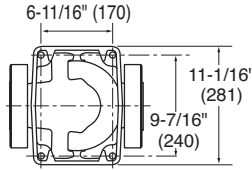
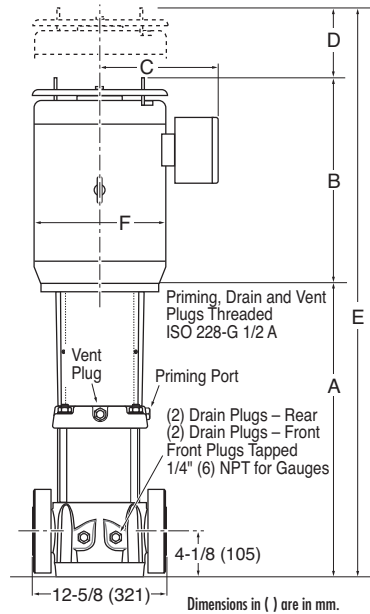

ANSI 300# 2-1/2" (64) 8-Bolt Flange
(6-11 Stage Pumps)

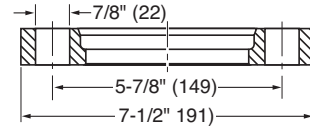

ANSI 150# 2-1/2" (64) 4-Bolt Flange
(1-5 Stage Pumps)

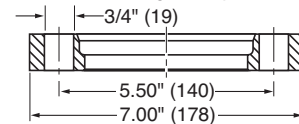

TECHNICAL INFORMATION	
MINIMUM PUMPING RATES	Up to 175° F (79° C) – 12.5 GPM (47.3 LPM) 175° F (79° C) to 250° F (121° C) – 29 GPM (109.8 LPM)
FLOW RANGE	12.5 – 175 GPM (12.5 – 662.4 LPM)
MIN. SUCTION PIPE SIZES	2-1/2" (64 mm) Nominal Diameter, Schedule 40 Pipe
MAX. WORKING PRESSURE	435 PSI
MAX. AMBIENT TEMP.	104° F (40° C)
LIQUID TEMP. RANGE	+5° F to +250° F (-15° C to 121° C)
MOTOR OPTIONS	TEFC or ODP Single or Three Phase For other options, consult factory.
CONSTRUCTION MATERIALS	See Page 37

Model Number	HP (kW)	Motor S.F.	ph	Volts	Frame Size	Disc. Size in Inches (mm)	Suction Size in Inches (mm)	Sleeve in Inches (mm)	Dimensions in Inches (mm)*						TEFC Wt. Lbs. (kg)
									A	B	C	D	E	F	
PVM32-1-1D	2 (1.49)	1.4	1	110/220	182TCZ	2.5 (64)	2.5 (64)	3.78 (96)	22.3 (566)	13.9 (353)	7.9 (201)	2.6 (66)	38.8 (986)	10.0 (254)	186 (85)
PVM32-1-1D	2 (1.49)	1.4	3	190/380	182TCZ	2.5 (64)	2.5 (64)	3.78 (96)	22.3 (566)	12.6 (320)	6.9 (175)	2.6 (66)	37.5 (953)	8.6 (218)	166 (76)
PVM32-1D	3 (2.24)	1.4	1	110/220	213TCZ	2.5 (64)	2.5 (64)	3.78 (96)	22.3 (566)	13.9 (353)	7.9 (201)	2.6 (66)	38.8 (986)	10.0 (254)	220 (100)
PVM32-1D	3 (2.24)	1.4	3	190/380	184TCZ	2.5 (64)	2.5 (64)	3.78 (96)	22.3 (566)	12.6 (320)	6.9 (175)	2.6 (66)	37.5 (953)	8.6 (218)	181 (82)
PVM32-2-2D	5 (3.73)	1.4	1	110/220	213TCZ	2.5 (64)	2.5 (64)	6.54 (166)	27.0 (686)	13.9 (353)	7.9 (201)	2.6 (66)	43.5 (1105)	10.0 (254)	236 (107)
PVM32-2-2D	5 (3.73)	1.4	3	190/380	213TCZ	2.5 (64)	2.5 (64)	6.54 (166)	27.0 (686)	13.9 (353)	8.1 (206)	2.6 (66)	43.5 (1105)	10.3 (262)	240 (109)
PVM32-2-1D	5 (3.73)	1.4	1	110/220	213TCZ	2.5 (64)	2.5 (64)	6.54 (166)	27.0 (686)	13.9 (353)	7.9 (201)	2.6 (66)	43.5 (1105)	10.0 (254)	236 (107)
PVM32-2-1D	5 (3.73)	1.4	3	190/380	213TCZ	2.5 (64)	2.5 (64)	6.54 (166)	27.0 (686)	13.9 (353)	8.1 (206)	2.6 (66)	43.5 (1105)	10.3 (262)	240 (109)
PVM32-2D	5 (3.73)	1.4	1	110/220	213TCZ	2.5 (64)	2.5 (64)	6.54 (166)	27.0 (686)	13.9 (353)	7.9 (201)	2.6 (66)	43.5 (1105)	10.0 (254)	236 (107)
PVM32-2D	5 (3.73)	1.4	3	190/380	213TCZ	2.5 (64)	2.5 (64)	6.54 (166)	27.0 (686)	13.9 (353)	8.1 (206)	2.6 (66)	43.5 (1105)	10.3 (262)	240 (109)
PVM32-3-2D	7.5 (5.59)	1.15	1	110/220	215TCZ	2.5 (64)	2.5 (64)	9.29 (236)	29.8 (757)	13.9 (353)	7.9 (201)	3.1 (79)	46.8 (1189)	10.0 (254)	269 (122)
PVM32-3-2D	7.5 (5.59)	1.15	3	190/380	215TCZ	2.5 (64)	2.5 (64)	9.29 (236)	29.8 (757)	14.2 (361)	8.1 (206)	3.1 (79)	47.1 (1196)	10.3 (262)	266 (121)
PVM32-3D	10 (7.46)	1.15	3	190/380	254TCZ	2.5 (64)	2.5 (64)	9.29 (236)	29.8 (757)	20.0 (508)	9.5 (241)	4.0 (102)	53.8 (1367)	12.9 (328)	357 (162)
PVM32-4-2D	10 (7.46)	1.15	3	190/380	254TCZ	2.5 (64)	2.5 (64)	12.05 (306)	32.5 (826)	20.0 (508)	9.5 (241)	4.0 (102)	56.5 (1435)	12.9 (328)	360 (163)
PVM32-4D	10 (7.46)	1.15	3	190/380	254TCZ	2.5 (64)	2.5 (64)	12.05 (306)	32.5 (826)	20.0 (508)	9.5 (241)	4.0 (102)	56.5 (1435)	12.9 (328)	360 (163)
PVM32-5-2D	15 (11.19)	1.15	3	190/380	254TCZ	2.5 (64)	2.5 (64)	14.80 (376)	35.3 (897)	16.9 (429)	9.2 (234)	3.8 (97)	56.0 (1422)	11.5 (292)	406 (184)
PVM32-5D	15 (11.19)	1.15	3	190/380	254TCZ	2.5 (64)	2.5 (64)	14.80 (376)	35.3 (897)	16.9 (429)	9.2 (234)	3.8 (97)	56.0 (1422)	11.5 (292)	406 (184)
PVM32-6-2D	20 (14.91)	1.15	3	190/380	284TCZ	2.5 (64)	2.5 (64)	17.56 (446)	38.0 (965)	20.0 (508)	9.5 (241)	3.0 (76)	61.0 (1549)	13.3 (338)	425 (193)
PVM32-6D	20 (14.91)	1.15	3	190/380	284TCZ	2.5 (64)	2.5 (64)	17.56 (446)	38.0 (965)	20.0 (508)	9.5 (241)	3.0 (76)	61.0 (1549)	13.3 (338)	425 (193)
PVM32-7-2D	20 (14.91)	1.15	3	190/380	284TCZ	2.5 (64)	2.5 (64)	20.31 (516)	40.8 (1036)	20.0 (508)	9.5 (241)	3.0 (76)	63.8 (1621)	13.3 (338)	428 (194)
PVM32-7D	25 (18.64)	1.15	3	190/380	284TCZ	2.5 (64)	2.5 (64)	20.31 (516)	40.8 (1036)	23.9 (607)	13.1 (333)	3.0 (76)	67.7 (1720)	15.6 (396)	441 (200)
PVM32-8-2D	25 (18.64)	1.15	3	190/380	284TCZ	2.5 (64)	2.5 (64)	23.07 (586)	43.6 (1107)	23.9 (607)	13.1 (333)	3.0 (76)	70.5 (1791)	15.6 (396)	444 (201)
PVM32-8D	25 (18.64)	1.15	3	190/380	284TCZ	2.5 (64)	2.5 (64)	23.07 (586)	43.6 (1107)	23.9 (607)	13.1 (333)	3.0 (76)	70.5 (1791)	15.6 (396)	444 (201)
PVM32-9-2D	30 (22.37)	1.15	3	190/380	284TCZ	2.5 (64)	2.5 (64)	25.83 (656)	46.3 (1176)	23.2 (589)	13.1 (333)	3.0 (76)	72.5 (1842)	15.6 (396)	447 (203)
PVM32-9D	30 (22.37)	1.15	3	190/380	284TCZ	2.5 (64)	2.5 (64)	25.83 (656)	46.3 (1176)	23.2 (589)	13.1 (333)	3.0 (76)	72.5 (1842)	15.6 (396)	434 (197)
PVM32-10-2D	30 (22.37)	1.15	3	190/380	284TCZ	2.5 (64)	2.5 (64)	28.58 (726)	49.1 (1247)	23.2 (589)	13.1 (333)	3.0 (76)	75.3 (1913)	15.6 (396)	436 (198)
PVM32-10D	30 (22.37)	1.15	3	190/380	284TCZ	2.5 (64)	2.5 (64)	28.58 (726)	49.1 (1247)	23.2 (589)	13.1 (333)	3.0 (76)	75.3 (1913)	15.6 (396)	436 (198)
PVM32-11-2D	30 (22.37)	1.15	3	190/380	284TCZ	2.5 (64)	2.5 (64)	31.34 (796)	51.8 (1316)	23.2 (589)	13.1 (333)	3.0 (76)	78.0 (1981)	15.6 (396)	439 (199)
PVM32-11D	30 (22.37)	1.15	3	190/380	284TCZ	2.5 (64)	2.5 (64)	31.34 (796)	51.8 (1316)	23.2 (589)	13.1 (333)	3.0 (76)	78.0 (1981)	15.6 (396)	439 (199)
PVM32-12-2D	30 (22.37)	1.15	3	190/380	284TCZ	2.5 (64)	2.5 (64)	34.09 (866)	54.6 (1387)	23.2 (589)	13.1 (333)	3.0 (76)	80.8 (2052)	15.6 (396)	442 (200)
PVM32-12D	30 (22.37)	1.15	3	190/380	284TCZ	2.5 (64)	2.5 (64)	34.09 (866)	54.6 (1387)	23.2 (589)	13.1 (333)	3.0 (76)	80.8 (2052)	15.6 (396)	442 (200)
PVM32-13-2D	30 (22.37)	1.15	3	190/380	284TCZ	2.5 (64)	2.5 (64)	36.85 (936)	57.3 (1455)	23.2 (589)	13.1 (333)	3.0 (76)	83.5 (2121)	15.6 (396)	444 (202)
PVM32-13D	30 (22.37)	1.15	3	190/380	284TCZ	2.5 (64)	2.5 (64)	36.85 (936)	57.3 (1455)	23.2 (589)	13.1 (333)	3.0 (76)	83.5 (2121)	15.6 (396)	444 (202)
PVM32-14-2D	30 (22.37)	1.15	3	190/380	284TCZ	2.5 (64)	2.5 (64)	39.61 (1006)	60.1 (1527)	23.2 (589)	13.1 (333)	3.0 (76)	86.3 (2192)	15.6 (396)	447 (203)
PVM32-14D	30 (22.37)	1.15	3	190/380	284TCZ	2.5 (64)	2.5 (64)	39.61 (1006)	60.1 (1527)	23.2 (589)	13.1 (333)	3.0 (76)	86.3 (2192)	15.6 (396)	447 (203)

*Measurements represent the largest number possible for each model using standard efficiency motors.

Description	Material
Shaft	AISI 431 SS
Impellers, Diffuser Chambers, Pump Sleeve Split Cones, Split Cone Nuts and Suction Interconnector	AISI 304 SS
Motor Stool	Class 30 Cast Iron
Suction / Discharge, Pump Head and Motor Couplings	80-55-06 Ductile Iron
Intermediate Bearings	Leadless Tin Bronze
Diffuser Sleeves	Graphite
Lower Shaft, Stabilizer Bearing and Bearing Ring	Tungsten Carbide
O-Rings	EPDM opt: Viton®, Buna-N
Neck Rings	Teflon®
Coupling Guard	AISI 304 SS
Staybolts, Nuts and Washers	Zinc Plated Steel
Mechanical Seal: Stationary Face Rotating Face O-Rings Upper and Lower Drivers Spring	Tungsten Carbide Tungsten Carbide EPDM opt: Viton®, Buna-N AISI 304 SS or Better AISI 316 SS
Seal Carrier	UNIC 40 Epoxy Coated Steel

Permissible Operating Pressure Curves

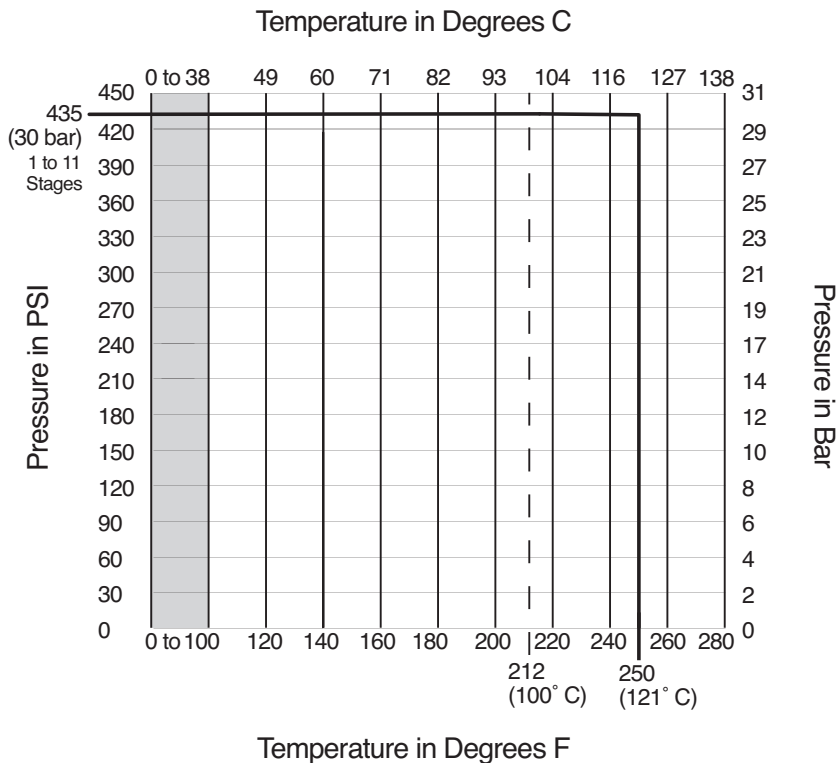

BYPASS ORIFICE SIZING

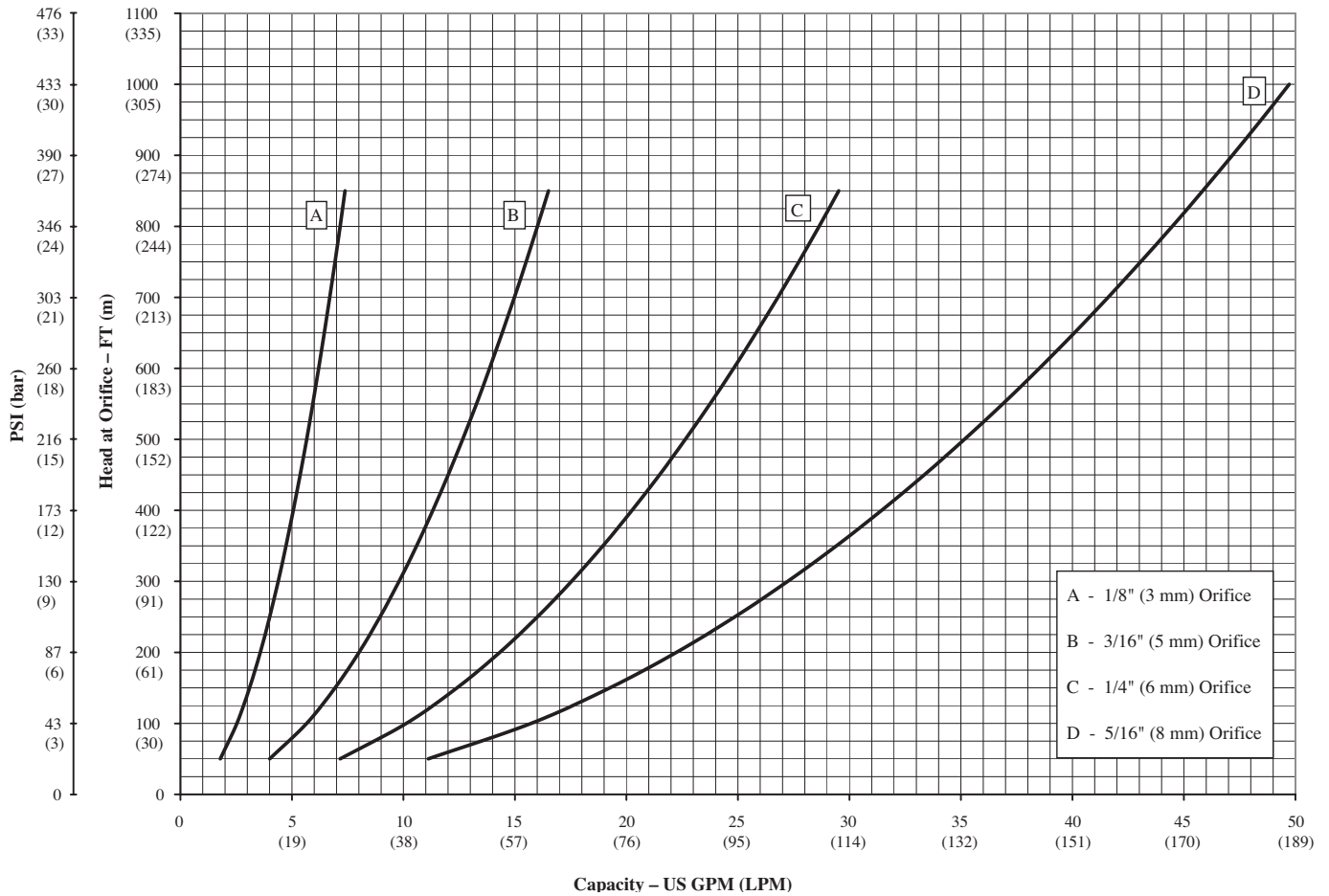

VERTICAL MULTISTAGE PERFORMANCE

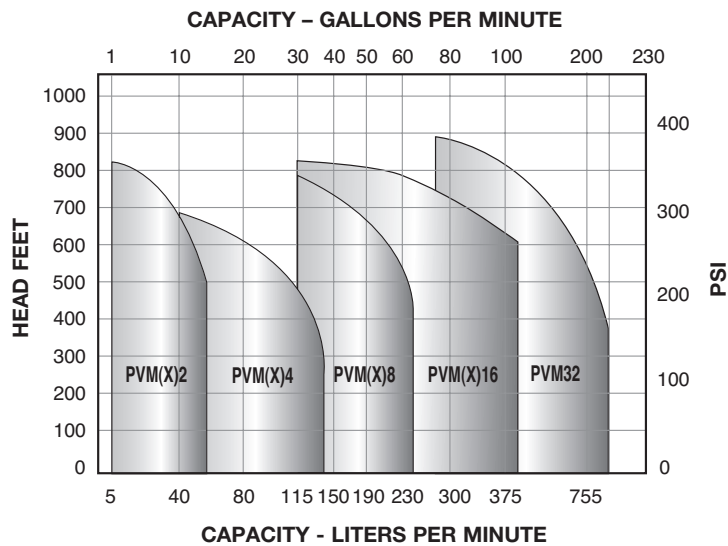

Models	Flow Series	HP (kW) Range	GPM (LPM)
PVM/PVMX	2	1/2 – 5 (.373 – 3.73)	1 – 20 (4 – 76)
PVM/PVMX	4	1/2 – 7.5 (.373 – 5.59)	3 – 40 (11 – 151)
PVM/PVMX	8	3/4 – 15 (.559 – 11.12)	5 – 65 (19 – 246)
PVM/PVMX	16	5 – 25 (3.73 – 18.64)	8 – 105 (30 – 397)
PVM	32	3 – 40 (2.24 – 29.83)	15 – 210 (57 – 795)

WARRANTY

Seller warrants equipment (and its component parts) of its own manufacture against defects in materials and workmanship under normal use and service for one (1) year from the date of installation or start-up, or for eighteen (18) months after the date of shipment, whichever occurs first. Seller does not warrant accessories or components that are not manufactured by Seller; however, to the extent possible, Seller agrees to assign to Buyer its rights under the original manufacturer's warranty, without recourse to Seller. Buyer must give Seller notice in writing of any alleged defect covered by this warranty (together with all identifying details, including the serial number, the type of equipment, and the date of purchase) within thirty (30) days of the discovery of such defect during the warranty period. No claim made more than 30 days after the expiration of the warranty period shall be valid. Guarantees of performance and warranties are based on the use of original equipment manufactured (OEM) replacement parts. Seller assumes no responsibility or liability if alterations, non-authorized design modifications and/or non-OEM replacement parts are incorporated. If requested by Seller, any equipment (or its component parts) must be promptly returned to Seller prior to any attempted repair, or sent to an authorized service station designated by Seller, and Buyer shall prepay all shipping expenses. Seller shall not be liable for any loss or damage to goods in transit, nor will any warranty claim be valid unless the returned goods are received intact and undamaged as a result of shipment. Repaired or replaced material returned to customer will be shipped F.O.B., Seller's factory. Seller will not give Buyer credit for parts or equipment returned to Seller, and will not accept delivery of any such parts or equipment, unless Buyer has obtained Seller's approval in writing. The warranty extends to repaired or replaced parts of Seller's manufacture for ninety (90) days or for the remainder of the original warranty period applicable to the equipment or parts being repaired or replaced, whichever is greater. This warranty applies to the repaired or replaced part and is not extended to the product or any other component of the product being repaired. Repair parts of its own manufacture sold after the original warranty period are warranted for a period of one (1) year from shipment against defects in materials and workmanship under normal use and service. This warranty applies to the replacement part only and is not extended to the product or any other component of the product being repaired. Seller may substitute new equipment or improve part(s) of any equipment judged defective without further liability. All repairs or services performed by Seller, which are not covered by this warranty, will be charged in accordance with Seller's standard prices then in effect.

THIS WARRANTY IS THE SOLE WARRANTY OF SELLER AND SELLER HEREBY EXPRESSLY DISCLAIMS AND BUYER WAIVES ALL OTHER WARRANTIES EXPRESSED, IMPLIED IN LAW OR IMPLIED IN FACT, INCLUDING ANY WARRANTIES OF MERCHANTABILITY OR FITNESS FOR A PARTICULAR PURPOSE. Seller's sole obligation under this warranty shall be, at its option, to repair or replace any equipment (or its component parts) which has a defect covered by this warranty, or to refund the purchase price of such equipment or part. Under the terms of this warranty, Seller shall not be liable for (a) consequential, collateral, special or liquidated losses or damages; (b) equipment conditions caused by normal wear and tear, abnormal conditions of use, accident, neglect, or misuse of said equipment; (c) the expense of, and loss or damage caused by, repairs or alterations made by anyone other than the Seller; (d) damage caused by abrasive materials, chemicals, scale deposits, corrosion, lightning, improper voltage, mishandling, or other similar conditions; (e) any loss, damage, or expense relating to or resulting from installation, removal or reinstallation of equipment; (f) any labor costs or charges incurred in repairing or replacing defective equipment or parts, including the cost of reinstalling parts that are repaired or replaced by Seller; (g) any expense of shipment of equipment or repaired or replacement parts; or (h) any other loss, damage or expense of any nature.

The above warranty shall not apply to any equipment which may be separately covered by any alternate or special warranties.

PERFORMANCE: In the absence of Certified Pump Performance Tests, equipment performance is not warranted or guaranteed. Performance curves and other information submitted to Buyer are approximate and no warranty or guarantee shall be deemed to arise as a result of such submittal. All testing shall be done in accordance with Seller's standard policy under Hydraulic Institute procedures.

LIABILITY LIMITATIONS: Under no circumstances shall the Seller have any liability under the Order or otherwise for liquidated damages or for collateral, consequential or special damages or for loss of profits, or for actual losses or for loss of production or progress of construction, regardless of the cause of such damages or losses. In any event, Seller's aggregate total liability under the Order or otherwise shall not exceed the contract price.

ACTS OF GOD: Seller shall in no event be liable for delays in delivery of the equipment or other failures to perform caused by fires, acts of God, strikes, labor difficulties, acts of governmental or military authorities, delays in transportation or procuring materials, or causes of any kind beyond Seller's control.

COMPLIANCE WITH LAW: Seller agrees to comply with all United States laws and regulations applicable to the manufacturing of the subject equipment. Such compliance shall include: The Fair Labor Standards Acts of 1938, as amended; Equal Employment Opportunity clauses of Executive Order 11246, as amended; Occupational Safety and Health Act of 1970 and the standards promulgated thereunder, if applicable. Since compliance with the various Federal, State, and Local laws and regulations concerning occupational health and safety, pollution or local codes are affected by the use, installation and operation of the equipment and other matters over which Seller has no control, Seller assumes no responsibility for compliance with those laws and regulations, whether by way of indemnity, warranty, or otherwise. It is incumbent upon the Buyer to specify equipment which complies with local codes and ordinances.



AURORA®

800 Airport Road
North Aurora, Illinois 60542
630-859-7000
www.aurorapump.com